

FIG. 1-1. A Model 31 four-magazine Linotype. Many of the detail illustrations in this book are based upon this model. There are variations for specific purposes in other models, but the big scheme of simple operation applies to every Linotype.

---

# THE BIG SCHEME OF SIMPLE OPERATION

---

## *What the Linotype Is*

**T**HE LINOTYPE is not a type-setting machine. No types are used in it. It composes with matrices—small brass units having characters indented in the edges—hence the name “matrix.” These matrices are assembled into justified lines. From the matrix line the Linotype automatically casts a solid bar, or line, of type. This bar is known as the Linotype slug. It is ready for use when it leaves the machine.

The Linotype has four major divisions:

1. *The Magazines which contain the matrices.*—They represent type cases. Because every matrix circulates automatically back to its place in the magazine as soon as it has served in a line of composition, a font of matrices is small in number compared with a font of type. A magazine is so compact and light that the operator can handle it without exertion, and can produce a variety of composition by simply changing magazines.

2. *The Keyboard and its related parts.*—This controls the release of the matrices from the magazine in the order in which the characters are desired. The Linotype operator, from his seat at the keyboard, has complete control of every function of the machine. His duties are limited merely to operating the keyboard keys—justification and distribution are mechanically automatic.

3. *The Casting Mechanism.*—This division of the machine makes the Linotype-equipped printer his own type-founder. The justified line of matrices is presented automatically to the casting mechanism, molten type-metal is forced into the indented characters on the edges of the matrices, and the cast line, a single unit with a new type-face, is delivered to the galley on the machine, precisely trimmed and ready to go into the form.

4. *The Distributing Mechanism.*—When a line of matrices has served for casting the line of type, it is lifted automatically and carried to the top of the magazines, where, by a simple though ingenious system, each matrix is delivered to its proper place in the magazine, and is ready to serve again. Thus in the Linotype-equipped shop there is no distribution of type.

The small piece of brass shown in Fig. 4-1 is the key to everything the Linotype does. On the edge you will see indented characters. It is from these that the raised printing characters are cast on the face of the Linotype slug.

The Linotype is, in simplest terms, a machine for (1) assembling a number of these matrices in a row, or line; (2) automatically spacing that line to a desired length; (3) holding the indented characters of this line up against a casting mechanism of which they become a part and which molds the line of printing charac-

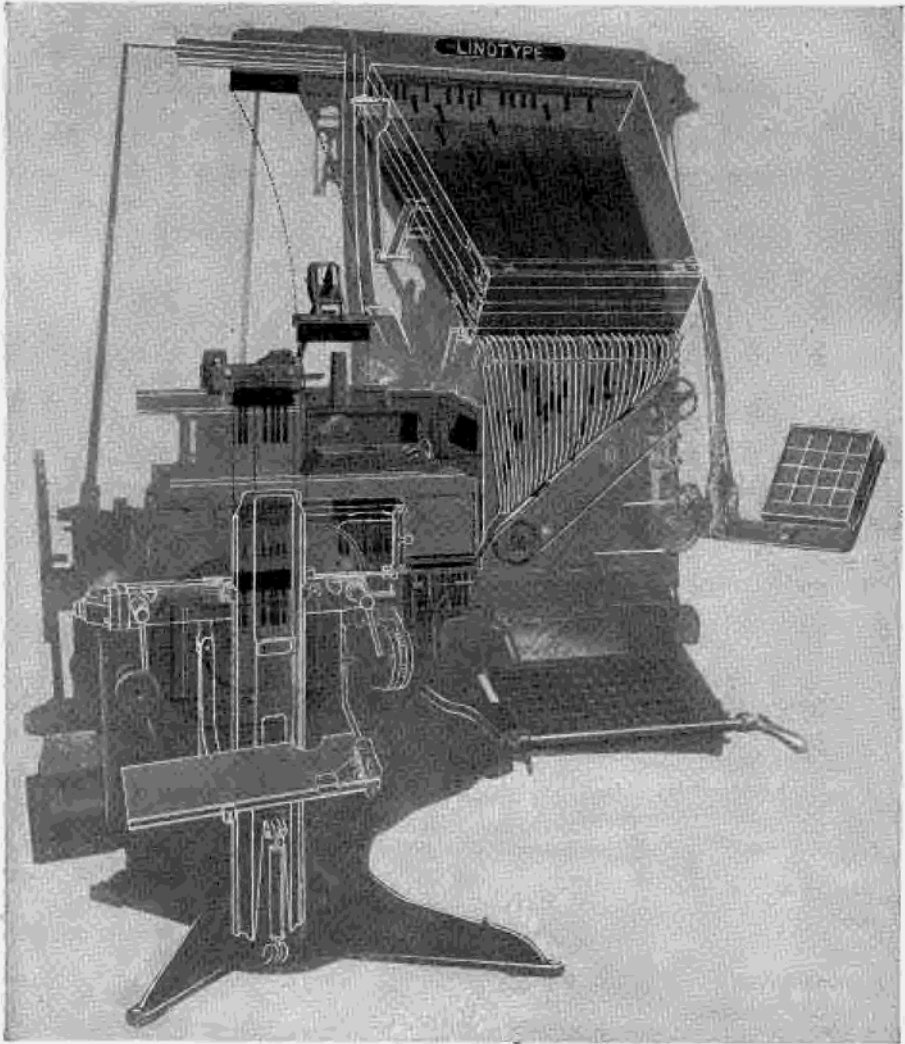

FIG. 2-1. Phantom illustration showing each stage of the circulation of the matrices through the Linotype.

ters on a bar or slug; and (4) transferring this line of matrices to their original positions in the magazine (see Fig. 6-1) where they may be used again. All these operations are automatic.

Note the teeth at the top. Each character has a different set of teeth. These guide it back to its proper place for repeated use.

The Linotype Company carries a stock of many millions of these matrices. Each of them requires an average of seventy different operations of extreme precision and careful inspection during the course of manufacture.

The spaceband consists merely of two thin wedge-shaped pieces of metal. They taper in opposite directions so that the outside faces are always parallel.

One of these will make a space between two words. Whenever the operator wants a space, he touches a special key on the keyboard, which makes one of these spacebands drop into the row of matrices.



FIG. 3-1. The cams assembled on the shaft actuate and control most of the mechanical actions of the Linotype. A one-third horse-power motor drives the entire machine.

Fig. 8-1 shows spaceband as it drops into the row of matrices. Notice that the bottom of the spaceband is beveled so that it will strike the matrix a glancing blow as it arrives, without causing damage to the matrix.

Fig. 9-1 shows a row of composed matrices and spacebands as they are assembled by the Linotype. The spacebands are shown partially raised to emphasize their function. With spacebands dropped, the line is ready to move over in front of the mold where the Linotype slug (shown in Fig. 10-1) will be cast from them.

These matrices and spacebands are assembled in a "stick" which holds them in a row until the line is complete. This "stick" is called the assembling elevator, and is shown in Fig. 27-1, Fig. 26-1 shows another view (greatly enlarged) of the elevator alone, and indicates how matrices are aligned for proper positioning.

A Linotype slug—a bar of metal with raised characters on its printing edge—is shown in Fig. 10-1. It is cast in the mold shown in Fig. 30-1, and this is the "line o' type" from which the Linotype gets its name.

The Linotype is a machine for manufacturing these slugs. It does this by assembling a line of matrices and spacebands (as shown on page 10, Fig. 9-1) and holding them against the mold into which molten metal is forced, producing the cast slug as shown in Fig. 10-1, page 10.

Six lines can be assembled, cast and distributed by the Linotype while one line would be set by hand, one-type-at-a-time. And after the slug is used it does not have to be distributed as does hand type. It is simply remelted and used again and again. The Linotype produces new

When the operator has assembled a line of matrices and spacebands, he sends it to the casting position. A bar rises and presses against the bottom of all the spacebands in the line and automatically justifies the line to the proper length.

This occurs because the upper part of each wedge is held firmly while the lower part rises and widens the space as needed.

After the casting operation they are automatically returned to the original position, and are, of course, used over and over again.

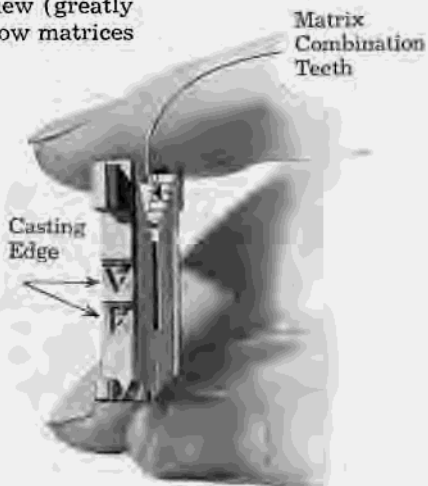

FIG. 4-1. The Linotype matrix.



FIG. 5-1. A few matrices of a wide variety of characters commonly used in printing. They are made in sizes from 4 point to condensed 60 point.

type matter, then, for every job, which, of course, improves the printed appearance because of its correct height and clear, sharp surface.

Linotype slugs are much more easily handled than single type. It is possible to pick up 50 or more of them at one time without pi-ing, so that make-up is simplified. Corrections in Linotype composition are made more expeditiously than in any other matter. Errors of omission through dropping or pulling out of single characters are entirely prevented.



FIG. 6-1. Linotype matrices are stored in magazines, from which they are released as explained on page 9. In this illustration the upper magazine has been cut away longitudinally to show all matrices of one character in "channel" which retains them.



FIG. 7-1. Front and side views of the Linotype spaceband.

When the operator presses the key, it releases the trigger 2 and allows the cam to drop onto the rubber roller 4, which rotates the cam and thereby makes the cam yoke 5, operate as a lever. The inner (right-hand) end of the cam yoke raises rod 1. The outer end remains in its regular position. When the cam has turned completely around, the cam yoke is caught up on trigger 2 again, to await its duty.

There is one of these devices for every key on the Linotype keyboard. They are in two rows just at the top of the keyboard. A section of the rows appears in Figs. 17 and 18-1.

The operator merely "starts something" when he lightly touches a key on the Linotype keyboard. By tipping the trigger 2 he starts a mechanical process which releases a matrix. This enables him to touch keys as fast as his fingers will travel. The average is about 150 matrices a minute.

Large faces as well as small are set on the Linotype in modern composing rooms. Fig. 13-1 shows a Linotype slug of large face with a body that is partly hollow (or recessed). Large slugs are cast this way to save metal and decrease weight.

When the operator touches one of the keyboard keys, the desired character is immediately released. Or if he touches the spaceband key, a spaceband is released and dropped.

The keyboard is built and arranged for speed and ease of operation. The keys for characters most frequently used are within easiest reach. The keyboard is set at the proper slope for the comfort of the operator's hands.

Only the lightest touch of a key is required to release a matrix or a spaceband.

When the operator touches a key of the Linotype, his action is transmitted into an upward push on rod 1, Fig. 16-1, which operates an escapement to allow the matrix to drop.

The action of the device shown in Fig. 16-1 is to transmit the operator's downward key pressure into the right kind of upward pressure.

This upward pressure is a correctly timed pressure, quite different from the human irregular pressure of the operator on the key. The cam device, 3, Fig. 16-1, is one of the things that makes the Linotype so smooth-running, so satisfactory and simple in its continuous operation over a period of years.

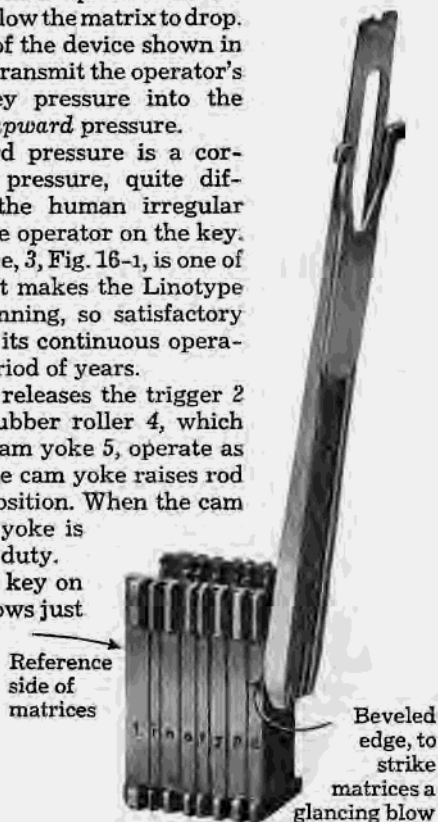

FIG. 8-1. View of spaceband dropping into line of matrices.

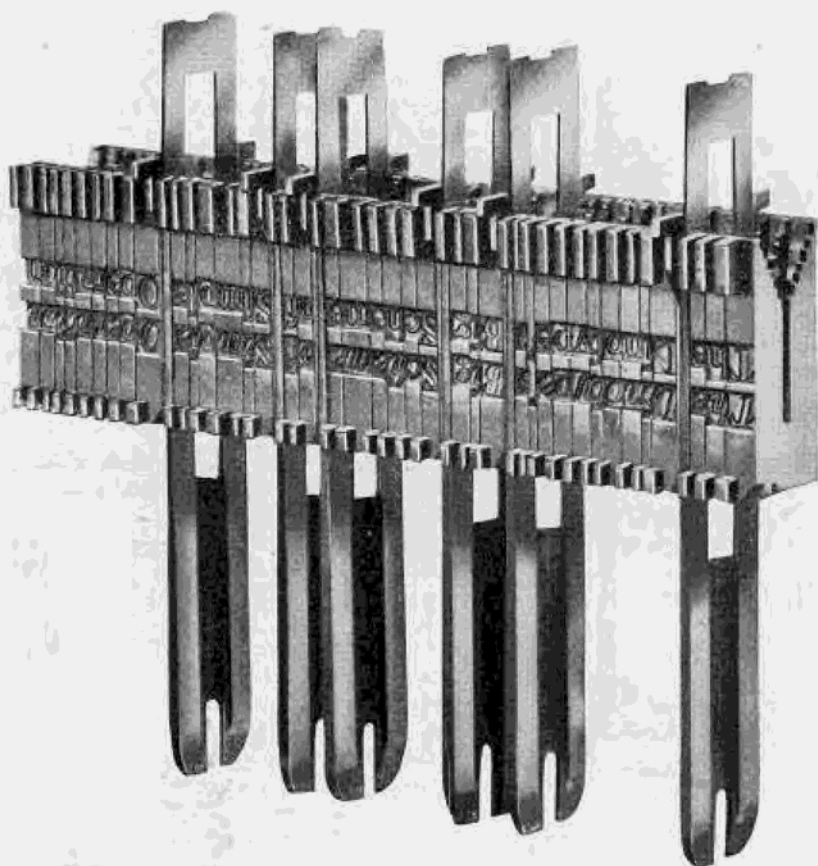

FIG. 9-1. A line of matrices and spacebands.

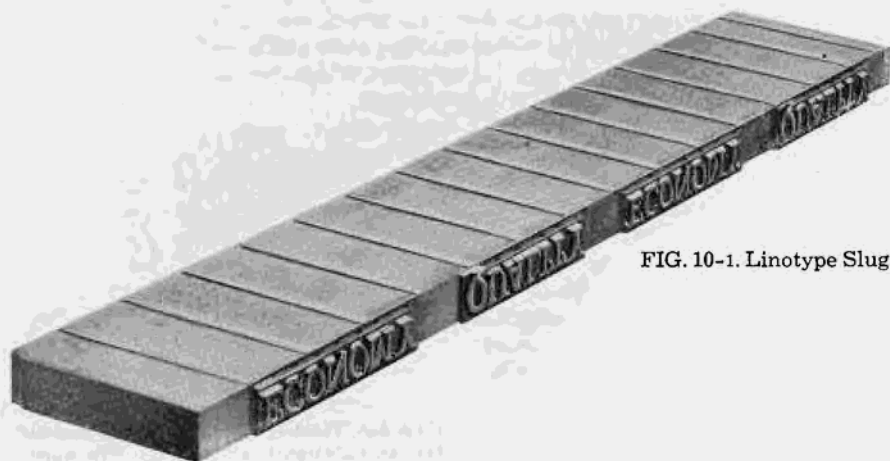

FIG. 10-1. Linotype Slug.



FIG. 11-1. Simplicity of handling has established the Linotype slug as the modern unit of composition.

In the illustrations Figs. 16 to 20-1 one cam is shown. Since there is one cam for every key on the keyboard, they extend entirely across the top of the keyboard in two soldier-like rows, one behind the other.

The operator can get at them by simply turning down the spring bar 1, to the position shown in Fig. 18-1. Thus the entire mechanism is made easily accessible.

Fig. 19-1 shows a cam removed from the keyboard. All that is necessary to remove one of the cams from the row is to press down on its corresponding key on the keyboard. Then the ordinary action of the cam will raise the yoke up out of the row so that the cam may be easily and simply lifted from its place with the fingers. No tools whatever are needed for this removal. Cam yokes in the back row are just as easily removed as those in the front row.

Fig. 20-1 shows the path of action started by the touch of the finger on a Linotype key. In this illustration, 1 is the Linotype matrix, ready to be released; 2, the escapement mechanism described on this and page 11. 3 is the cam frame described previously and illustrated in the enlarged views, Figs. 17 and 18-1. Also indicated are the magazine, channel entrance, and a matrix at the distributor bar.

The finger touch is transmitted toward the "top of the picture" by the rods, levers, etc., shown in this illustration and every one of these parts has a distinct purpose. *Every part of the Linotype is there because the machine is better for it, and all parts fit into the big scheme of simple operation.*

This picture leads us upward from the cam mechanism, to the escapement mechanism which in turn operates to release the matrices from the magazine in which they are stored.

Fig. 21-1 shows the mechanism which releases the matrices from their channels. It is called the escapement.

When the operator touches a key on his keyboard, 1 rocks and makes two small pawls, 2 and 3, slide up and down. When 2 slides down, the matrix drops.





FIG. 12-1. A recessed slug of a size used for body matter. It is cast in the recessed mold shown in Fig. 31-1.



FIG. 13-1. Display slug.



FIG. 14-1. Linotype slugs may be cast with an overhanging lip which permits large characters to lap over one or more adjacent slugs. The upper section of this illustration shows such a combination, and the lower, the two slugs separated. The mold in which they are cast is shown in Fig. 33-1.

When this key is touched a spaceband drops

Row of keyboard "cams" shown in Figs. 16, 17 and 18-1



FIG. 15-1. The Linotype keyboard.

At the same time, 3 catches the second, or oncoming matrix and holds it until 2 can slide up again to catch it. 2 and 3 "see-saw."

There is one of these escapements for each channel in the Linotype magazine. They are all in a row, usually not attached to the magazine. They can be lifted lightly off the machine in a neat frame, as shown in Fig. 23-1.

4 and 5 are solid, stationary pieces of metal which act as braces below the parts 2 and 3, so that the continual impact of matrices against the pawls will not wear, bend or loosen them.

The part illustrated in Fig. 23-1 contains the same number of escapements (shown individually in Fig. 21-1) as there are channels in the magazine. It is usually a part of the machine and is therefore not removed when one magazine is substituted for another. This construction lightens the weight of a magazine, safeguards it against abuse, damage in handling and dirt, all of which are responsible for transpositions and other preventable errors in composition.

When the escapement pawls release matrices, the matrices drop through the guides shown in Fig. 22-1, upon the moving assembler belt and are hastened down into the "stick," or assembling elevator 6, to the left of the bottom pulley.

A small spring 1 at the bottom of the belt gently breaks the speed of the falling matrices. This is called the "chute" finger and is illustrated in detail in Fig. 24-1.

There is a little star-shaped wheel 2, Fig. 22-1, of fiber which pushes the matrices into a line and holds them upright. This is the star-wheel. If the operator accidentally oversets a line and too many matrices come down, the star wheel ceases to turn and ceases to push automatically—another instance of the Linotype's almost human intelligence and self-protection.

By pushing a knob 3 at the right of the lower pulley the operator can instantly stop the belt, so that he can, if necessary, remove any surplus matrices from the bottom of the chute.

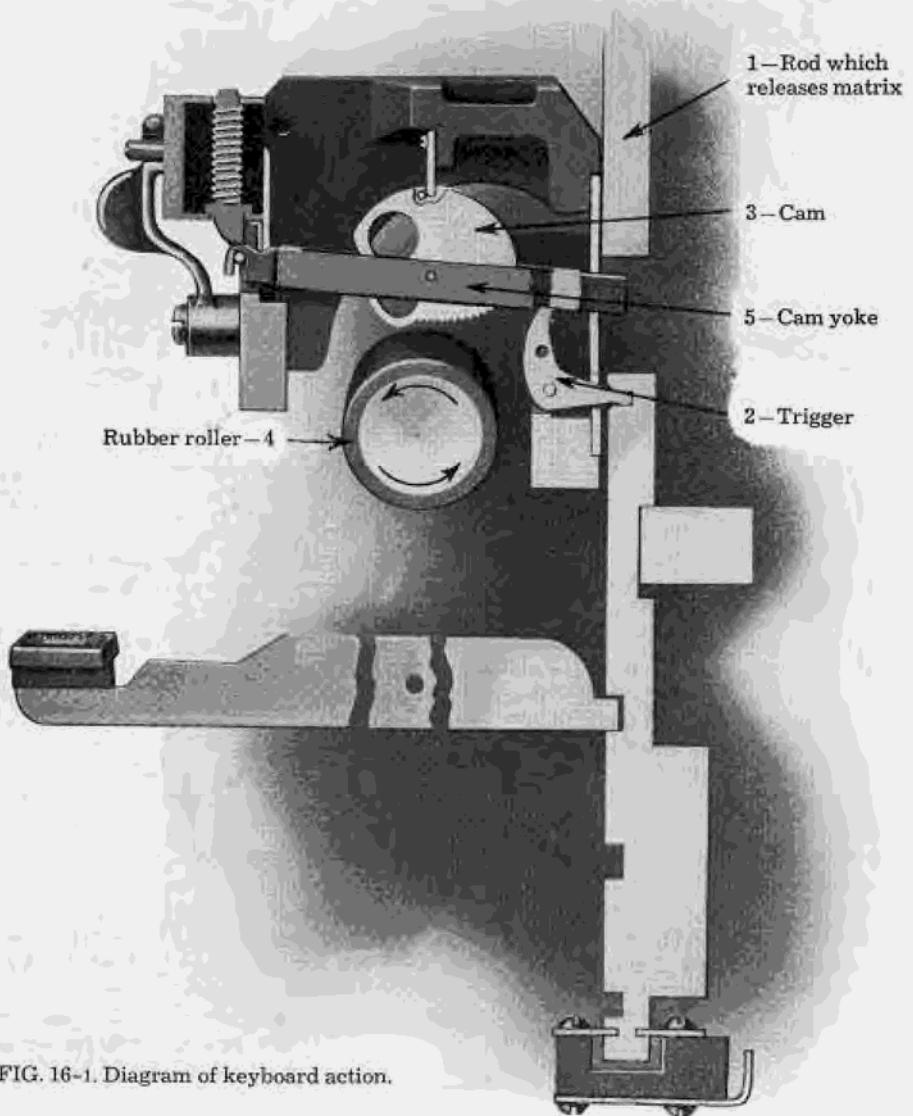

FIG. 16-1. Diagram of keyboard action.

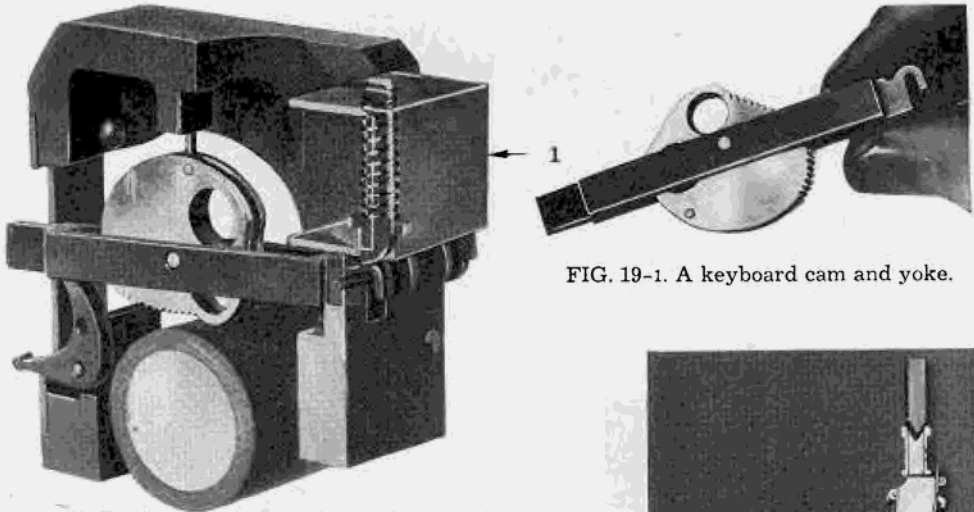

FIG. 17-1. Section of the keyboard cam frame.

FIG. 19-1. A keyboard cam and yoke.

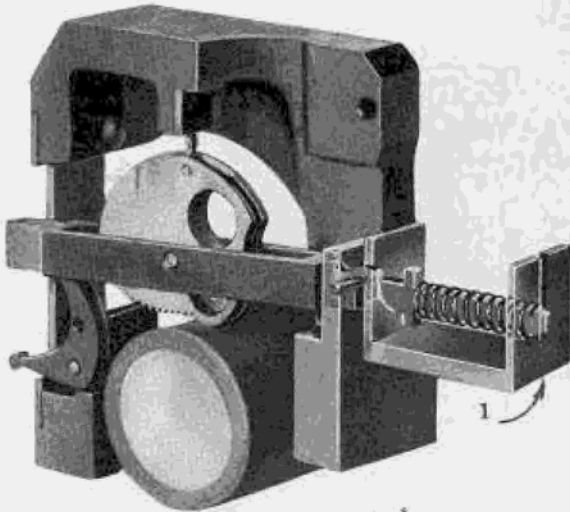

FIG. 18-1. Another section of the keyboard cam frame with spring bar open.

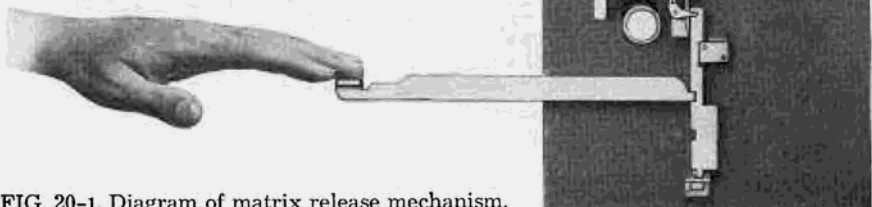

FIG. 20-1. Diagram of matrix release mechanism.

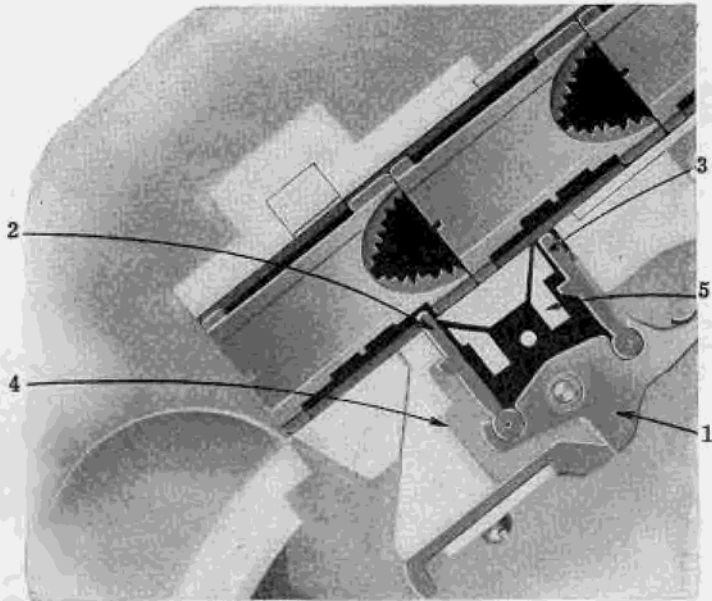

FIG. 21-1. The escapement mechanism.

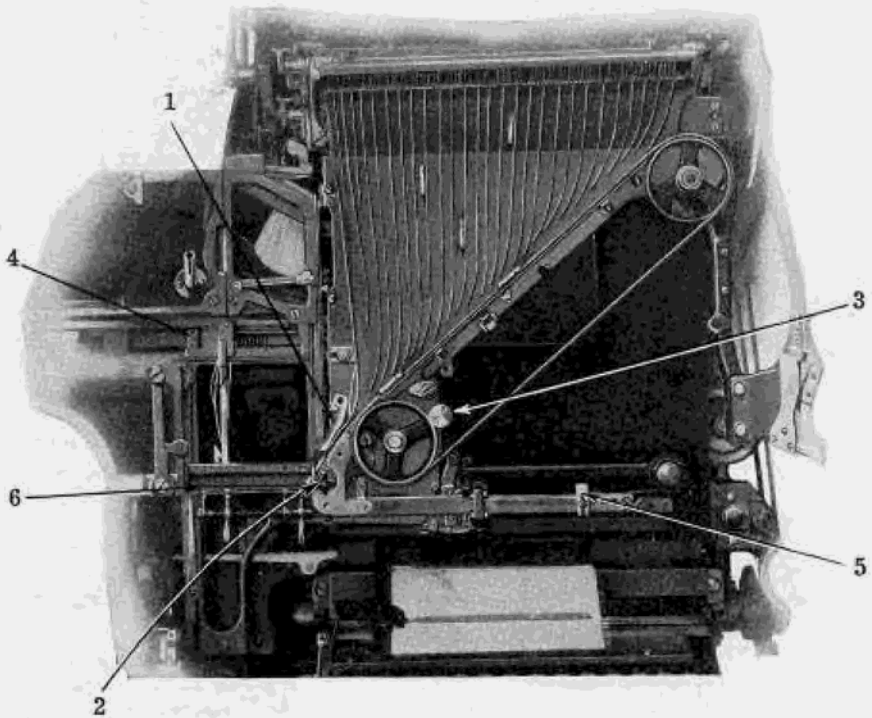

FIG. 22-1. View of assembler entrance.

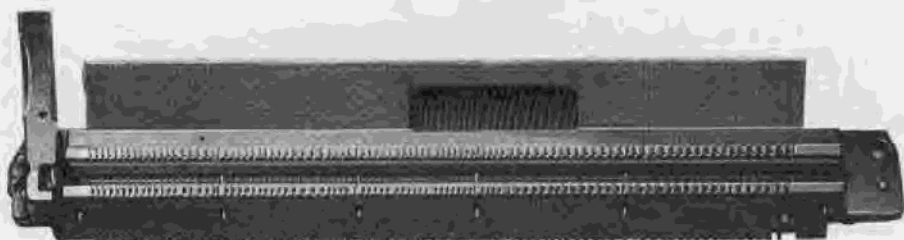

FIG. 23-1. An assembled escapement.

2

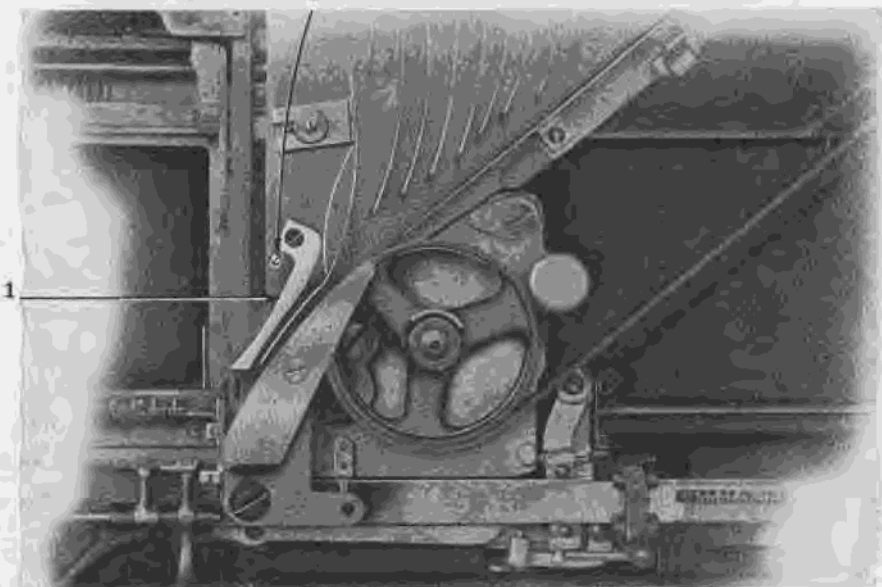

FIG. 24-1. The chute finger.

A change of measure in the assembling elevator 6, or on the delivery slide (the line-carrying device immediately above the assembling elevator), can be easily and quickly brought about by a slight pressure on, and a horizontal movement of, the stops 4 and 5.

The swift downward flight of the Linotype matrices is restrained at the bottom of the belt and rails by the finger 1, shown above, and known as the chute finger. A small tongue on the chute finger is held by spring pressure against a projecting stud 2. The angle at which the tongue rests on this stud determines the adjustment of the chute finger for various thicknesses and sizes of matrices.

On most of the Linotype matrices up to and including 14-point, and on all Duplex Display matrices, there are two letters or characters. That is, most matrices can



FIG. 25-1. The upper character is cast when the matrix is riding on the bottom rail of the "assembling" mechanism.

The lower character is cast when the matrix is riding on the top rail of the "assembling" mechanism.

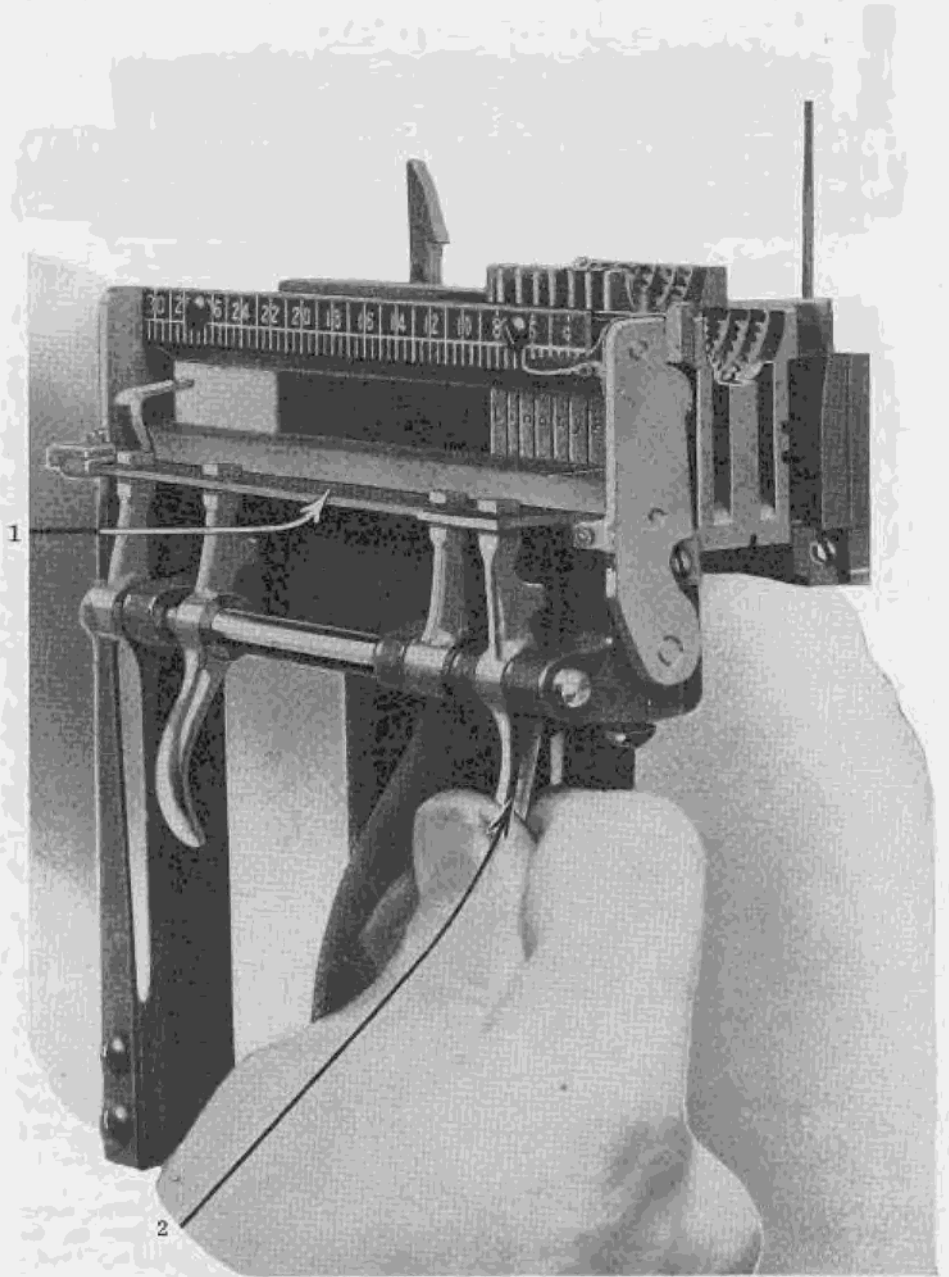

FIG. 26-1. This view indicates aligning and casting level. Assembled in this manner top characters of the lower matrices and bottom characters of the raised matrices will be cast in the same line.

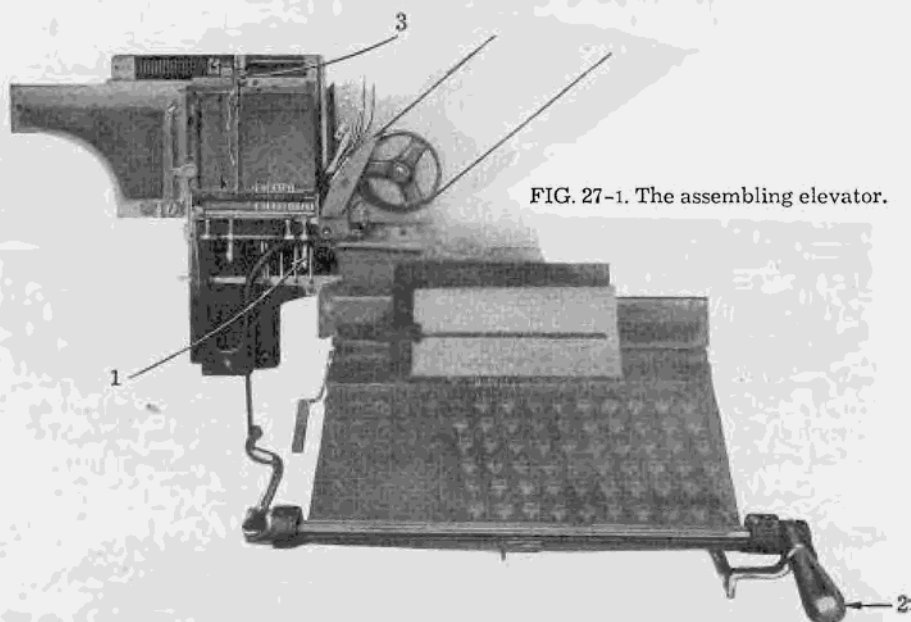

FIG. 27-1. The assembling elevator.

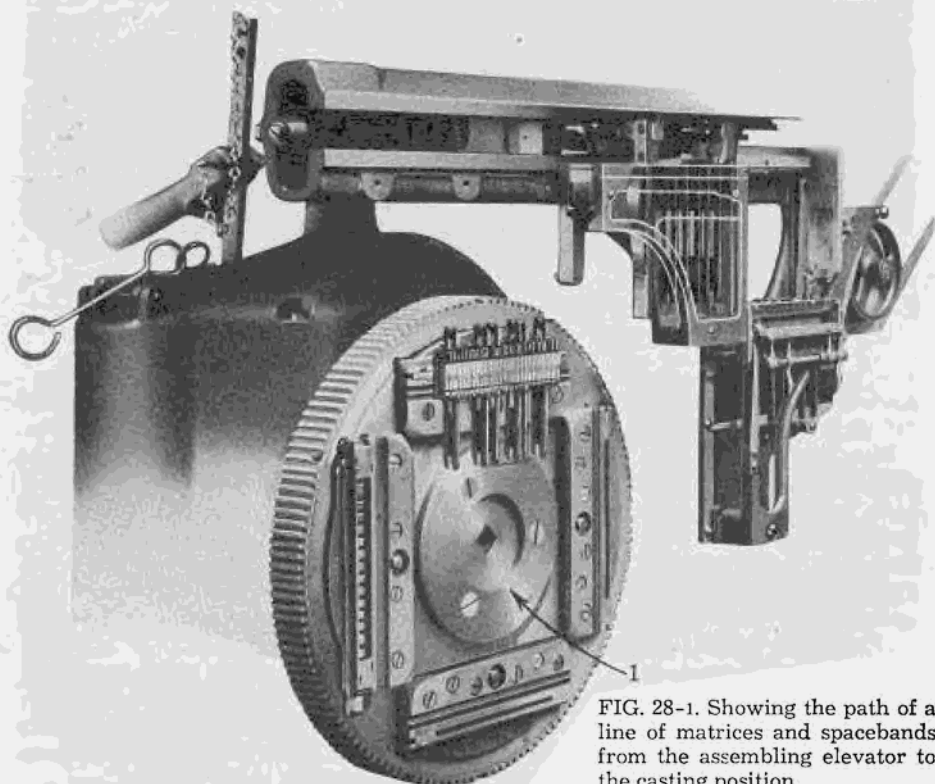

FIG. 28-1. Showing the path of a line of matrices and spacebands from the assembling elevator to the casting position.



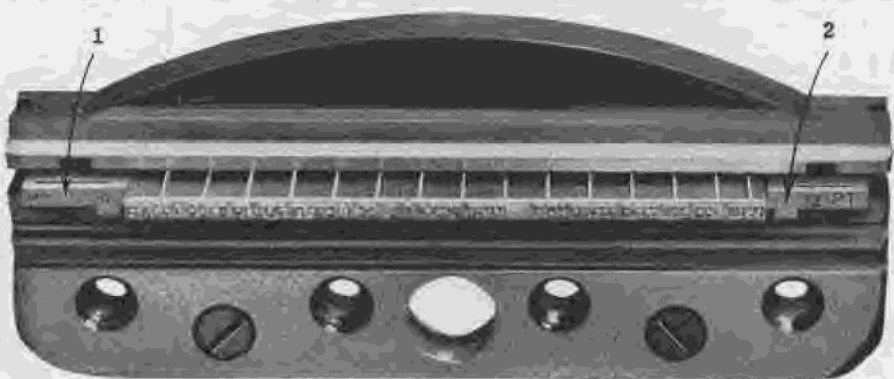

FIG. 29-1. The length of the mold slot (and the length of the slug) is determined by the length of the piece of metal, or liner, 1. If the point size of slug is to be changed liners 1 and 2 are removed and liners of different thickness inserted (Fig. 34-1).

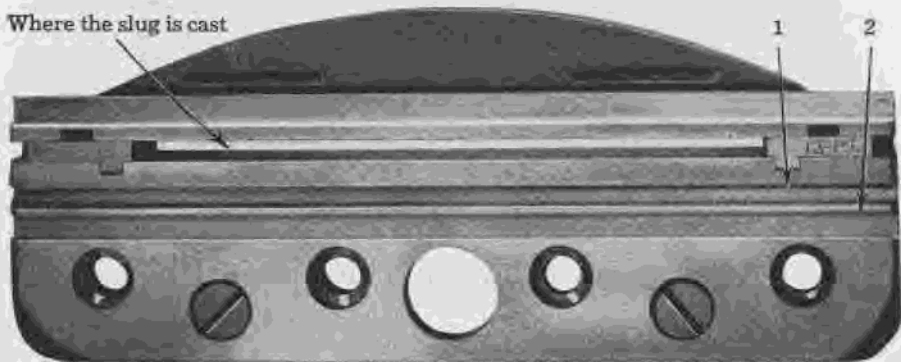

FIG. 30-1. Note the upper and lower rails (indicated by arrows 1 and 2 at the right) against which the matrices align to cast in the regular or auxiliary position as predetermined in the assembling elevator.

do double duty. For instance there may be a roman letter "k" and an italic letter "k" on the same matrix. (See Fig. 25-1.)

This doubles the capacity of the magazine, which holds the matrices, and doubles the range of the keyboard.

To get either a roman or an italic character, the operator presses the corresponding key on his keyboard. The matrix drops into the frame in which the line of matrices and spacebands is gathered—known as the assembling elevator. (This is called an elevator because it not only gathers the line of matrices and spacebands, but, after they are assembled, elevates them about five inches, to a position from which they are transferred to the "casting" position.)

The operator can decide whether roman or italic is to be cast. (See Fig. 26-1.)

In the assembling elevator and throughout the entire delivery mechanism there are two rails, or tracks, on which the matrices rest and ride. If matrices are assembled on the top rail, characters punched in the lower position will be cast; if assembled on the bottom rail roman characters will be cast.

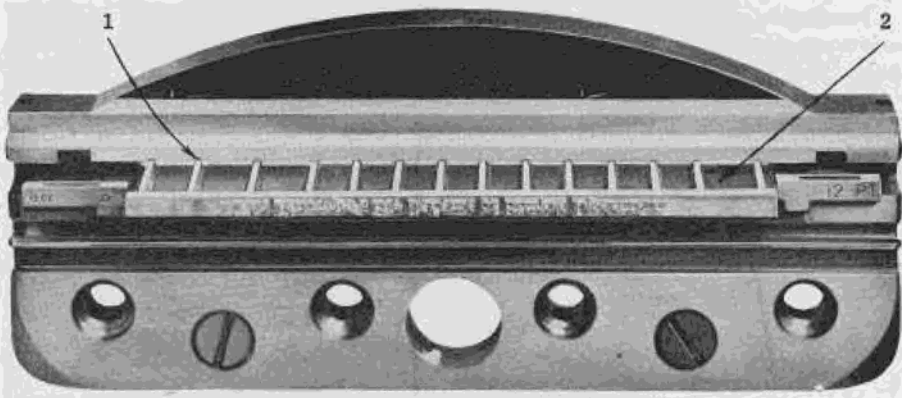

FIG. 31-1. Recessed mold.

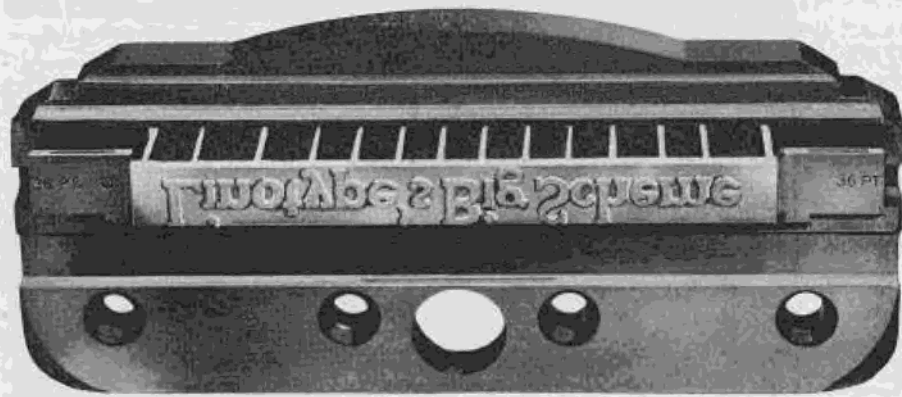

FIG. 32-1. Display mold.

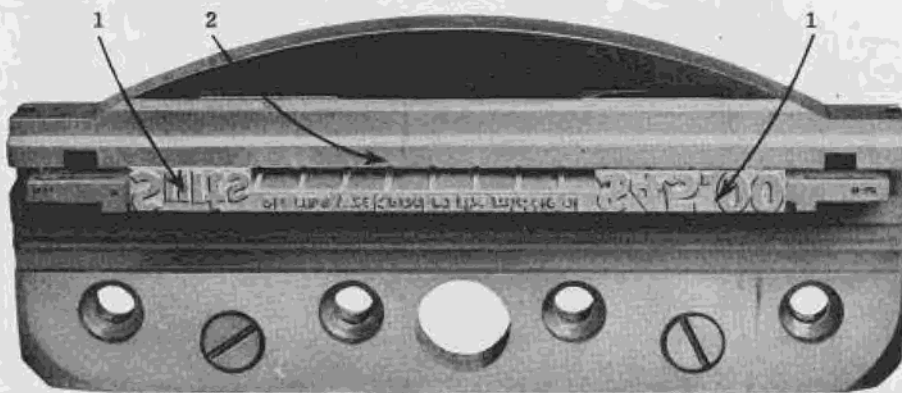

FIG. 33-1. Advertising figure mold.

Besides italic, the two-letter matrices are used to carry bold face, small caps, and in some cases a second type-face.

Single characters, words, sections of lines or entire lines may be set in bold face, in roman, italic or small caps, at will and without loss of time.

The operator will determine which rail the matrix shall assemble on, by pressing in or pulling out on the small lever 2, Fig. 26-1. This lever controls the first half-inch of the top rail—throws it in or out. If it is in, the matrices are all assembled on the top rail (this is called the *auxiliary* position). If it is out, the matrices are all assembled on the bottom rail (this is called the *regular* position).

If the operator leaves the first half inch of the top rail in, all of the matrices will assemble on the top rail, and be cast in the auxiliary position. If he leaves this first half inch of the top rail out, all of the matrices will then assemble on the bottom rail and be cast in the regular position.

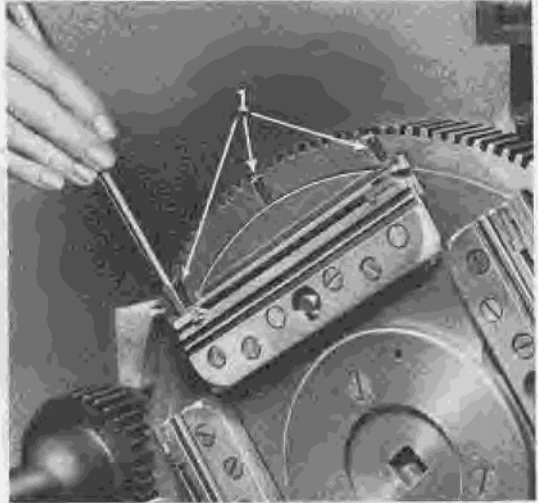

FIG. 34-1. View of method of changing mold liners.

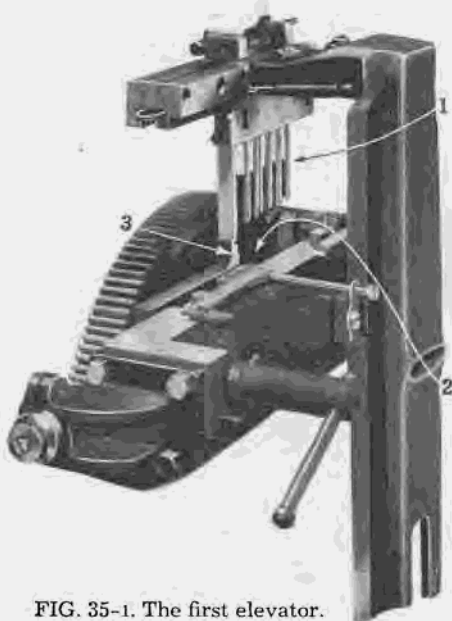

FIG. 35-1. The first elevator.

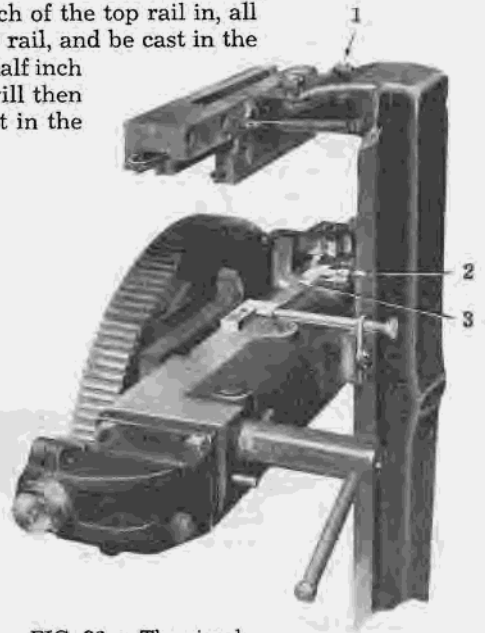

FIG. 36-1. The simple two-letter attachment. Adjusting screw 1 comes down on point 2, when this attachment is in use, and prevents the first elevator from descending farther. The matrices are thus held higher than usual, and the cast is made from their auxiliary characters.

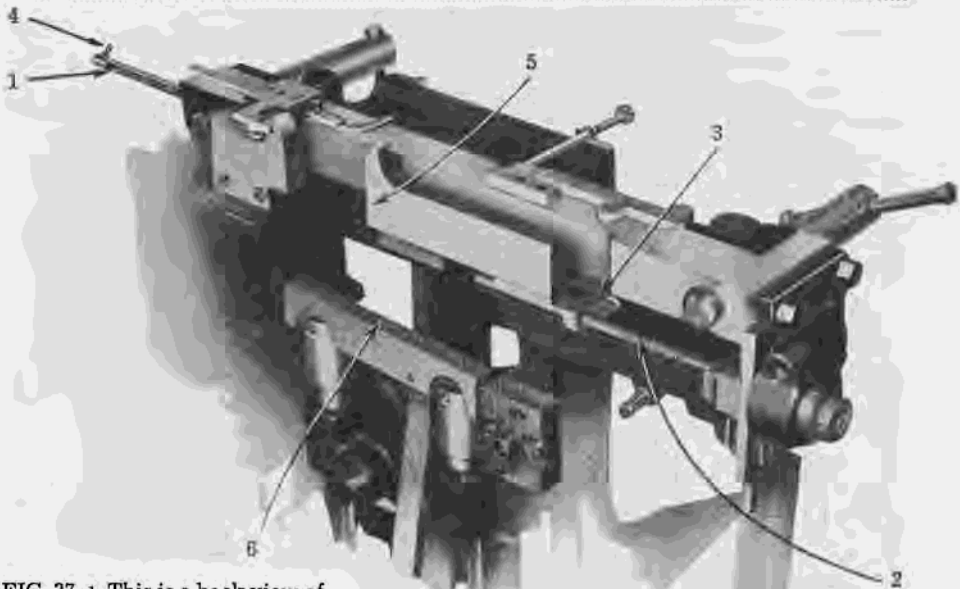

FIG. 37-1. This is a back view of the vise-like jaws between which the matrices and spacebands are held while they are in the casting position in front of the mold. The mold disk, of course, is not shown here as it would make this view impossible.

The assembling elevator, Fig. 27-1, is, in simplest terms, a device which catches and holds the assembling matrices and spacebands until there is a line full of them. It serves much the same purpose as a printer's stick. When it is full the operator depresses the lever 2 at the right of the keyboard, which lifts the assembling elevator about five inches, from which position the delivery slide 3 automatically carries the matrices and spacebands to the left into a jaw also having two rails which lowers them into position in front of the mold. This jaw is shown in Fig. 35-1 and in a different position in Fig. 38-1.

The matrices and spacebands face a mold in the disk and form the front of a slot into which molten metal is forced. There are four such molds on the large revolving disk (the mold disk).

It takes only an instant for the metal to be forced into the slot-like mold and into the characters in the matrices. The metal quickly cools, forming the Linotype slug with its clean new type.

The molds are adjustable to cast lines of varying length and thickness. These molds are removable and there are several different kinds, a number of which are shown in illustrations Fig. 29 to 33-1.

The center of the mold disk 1, shown in Fig. 28-1, page 19, is filled with circulating water for cooling—an exclusive Linotype feature, which permits greater speed when casting large slugs, guards against over-heating of mold and disk, and insures greater accuracy of product.

Fig. 29-1 shows a Universal Adjustable Mold removed from the disk with the main parts separated. It is adjustable as to the length and thickness of the slug it will cast. By removing the two pieces of metal (liners) 1 and 2, and substituting them with others, slugs of any length from 5 to 30 picas and from 5 up to 14 point in body may be cast.

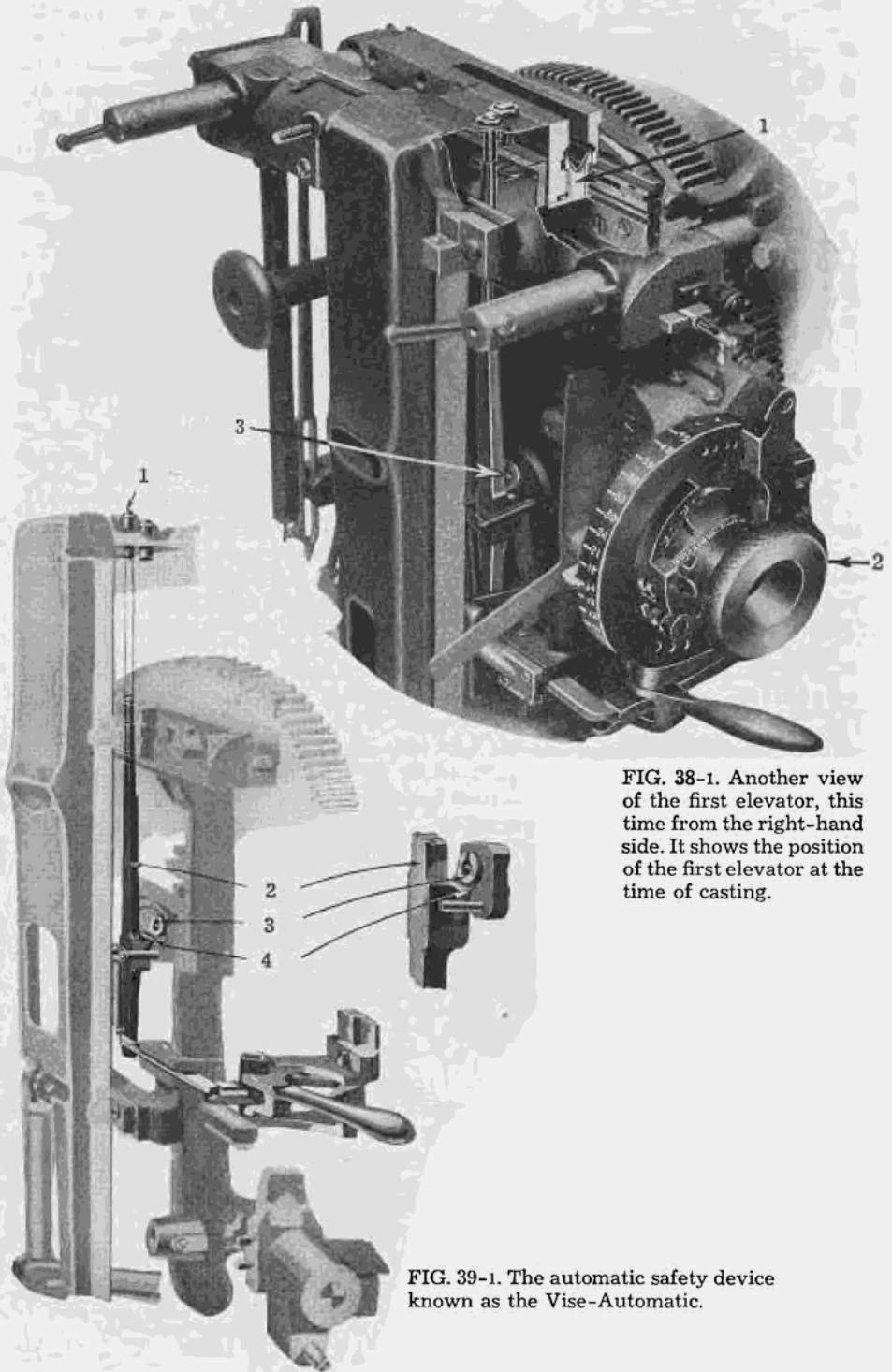

FIG. 38-1. Another view of the first elevator, this time from the right-hand side. It shows the position of the first elevator at the time of casting.

FIG. 39-1. The automatic safety device known as the Vise-Automatic.

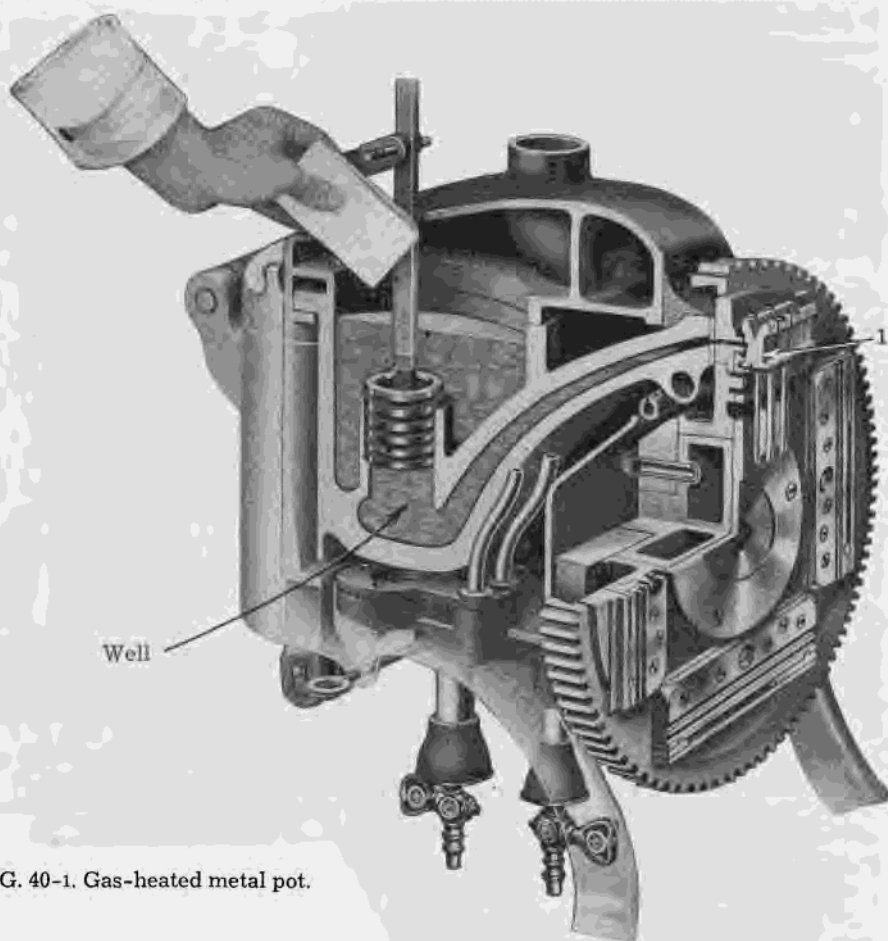

FIG. 40-1. Gas-heated metal pot.

Not more than one or two minutes are required to adjust the mold for any body and measure described. Since there are places for four molds in the disk, any one of which may be used at will, the necessity for changing liners arises only infrequently. Disks to accommodate six molds are provided for special needs.

In order to lead matter it is only necessary to use liners thicker than the face used. For instance, if leaded 6 point is required, 8 point liners may be inserted in the mold and 2 point leading will result.

It is not necessary for the thicker Linotype slugs to be solid metal. So, for the sake of light weight and quick cooling, provision is made for casting slugs with cavities, or recesses.

The Recessed Mold, shown in Fig. 31-1, is provided for slugs from 10 to 14 point. Note that the lower surface of the top section has rectangular projections and grooves 1. The molten metal is forced into these grooves, and forms supporting ribs beneath the "type" face. The rectangles form the recesses 2. In this manner, the weight of the slug is reduced about one-third.

The ribs give more than sufficient support to the face for normal stereotyping, electrotyping or direct printing.

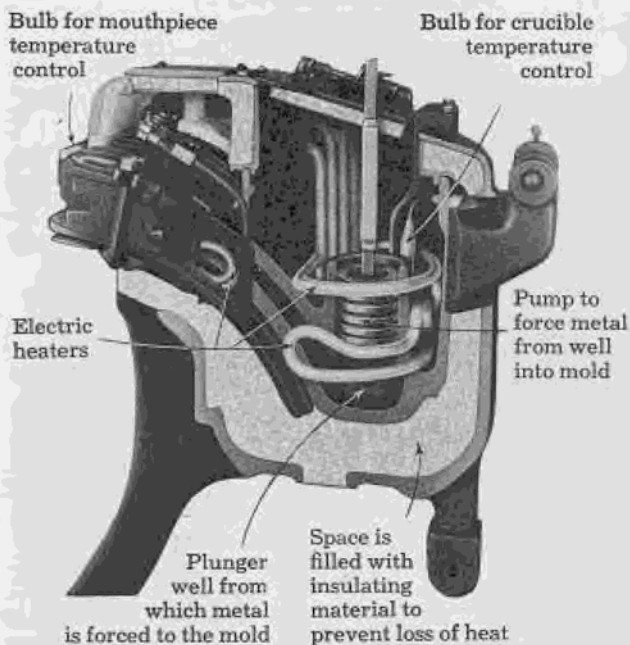

FIG. 41-1. Cross section of Linotype electric pot.

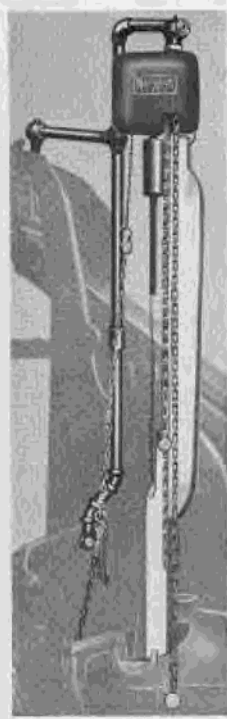

FIG. 42-1. Gas pot with metal feeder.

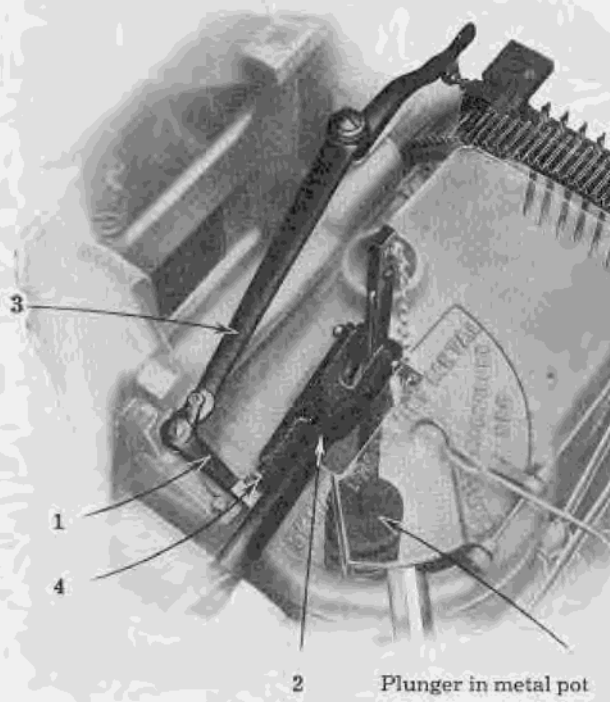

FIG. 43-1. The pot pump stop. Arm 1, which locks the pump lever 2, does not move back and allow pump lever to descend unless the front part of operating lever 3 is pressed to the right by a completely filled line of matrices and spacebands. If arm 1 has not moved back, catch block 4 on pump lever comes in contact with arm 1 and keeps the pump lever from descending.

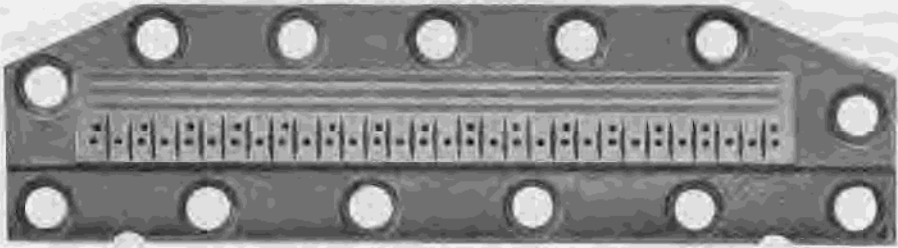

FIG. 44-1. Linotype mouthpiece.

Extra large slugs from 18 to 45 point, for display composition or head-letter composition, are cast in a Display Mold, Fig. 32-1, which forms greater recesses in the slug. The large projecting rectangles on the lower surface of the upper section of the mold, mean just that much metal saved in casting. The metal flows into the grooves between the rectangles and the supporting ribs in the slug result.

Lighter slugs cool more quickly and permit speedier composition. And lighter slugs are, of course, more conveniently handled. Furthermore, if slugs are to be stored, less metal is tied up.

Slugs with overhanging characters are cast in the Advertising-Figure Mold, shown in Fig. 33-1. The "overhanging" portions 1, are cast against an extra-thick lip 2. The combination of such slugs is illustrated in Fig. 14-1.

This mold provides the greatest possible range of type sizes and thus enables the operator to compose advertising and similar copy with a minimum of time and effort.

It is not necessary to remove the Linotype mold from the disk (and thus expose it to injury) in order to change liners for different lengths and thicknesses of slug. Nor are special tools necessary.

First loosen the three screws 1, shown in phantom in Fig. 34-1. Then, with the same screwdriver, the liners are easily slipped from between the cap and body of

the mold. Little notches in the tops of the liners are especially cut in order to accommodate the screwdriver. If the length only is to be changed, the right-hand liner need not be removed.

Returning now to the progress of the matrices through the machine, after the matrices and spacebands are assembled into a line in the assembling elevator and lifted, they are carried to the left into the first elevator and arrive in the position 1, shown in Fig. 35-1.

This first elevator lowers them into the space between a pair of vise-like jaws into the position 2, which they will occupy while the Linotype slug is being cast from them. The left-hand vise jaw 3, is adjustable to

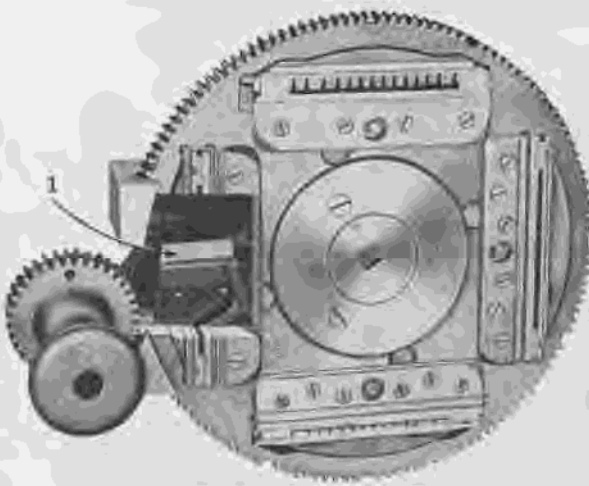
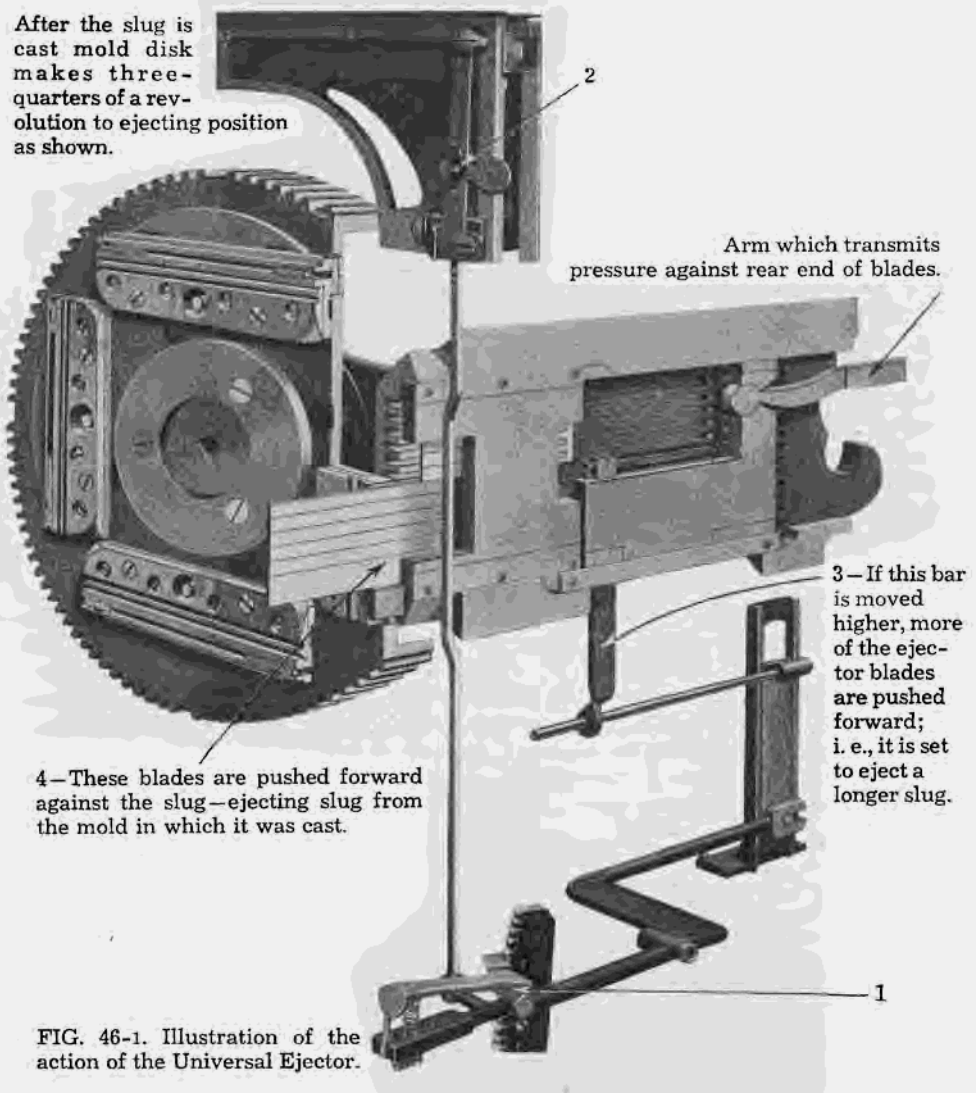

FIG. 45-1. View of mold disk with section removed to show back knife.



After the slug is cast mold disk makes three-quarters of a revolution to ejecting position as shown.



Arm which transmits pressure against rear end of blades.

3—If this bar is moved higher, more of the ejector blades are pushed forward; i. e., it is set to eject a longer slug.

4—These blades are pushed forward against the slug—ejecting slug from the mold in which it was cast.

FIG. 46-1. Illustration of the action of the Universal Ejector.

vary the length of the line of type on the slug in accordance with requirements.

After the casting operation is completed, the first elevator lifts the matrices and spacebands to a position higher than that shown in Fig. 35-1, from which position the matrices are transferred to the distributing mechanism and the spacebands to the spaceband box. (See Fig. 50-1.)

Fig. 36-1 shows the Linotype attachment which enables the operator to cast a slug from matrices in the auxiliary position without bothering to assemble the matrices in the auxiliary position in the assembling elevator.

For instance, when the operator wishes to cast several lines of italics from matrices on which there are both italic and roman characters, he simply sets the matrices in the normal way, then flips the filling-piece 3 over to the right. It

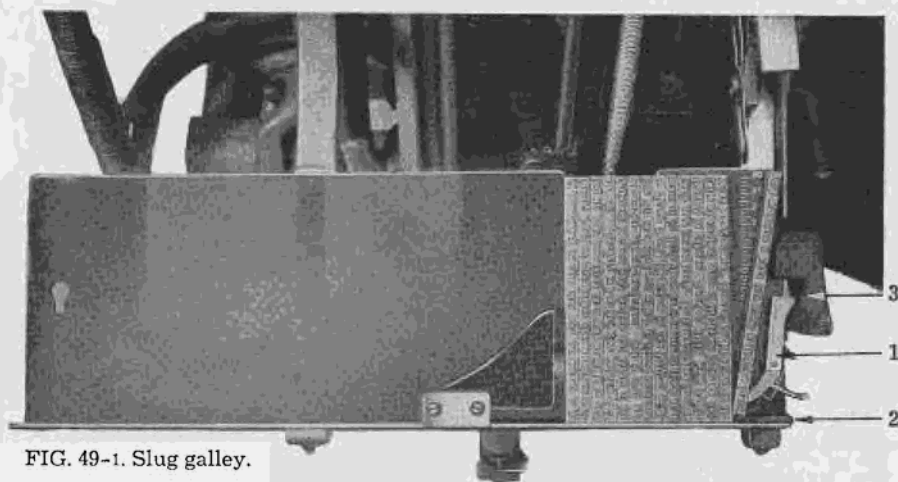
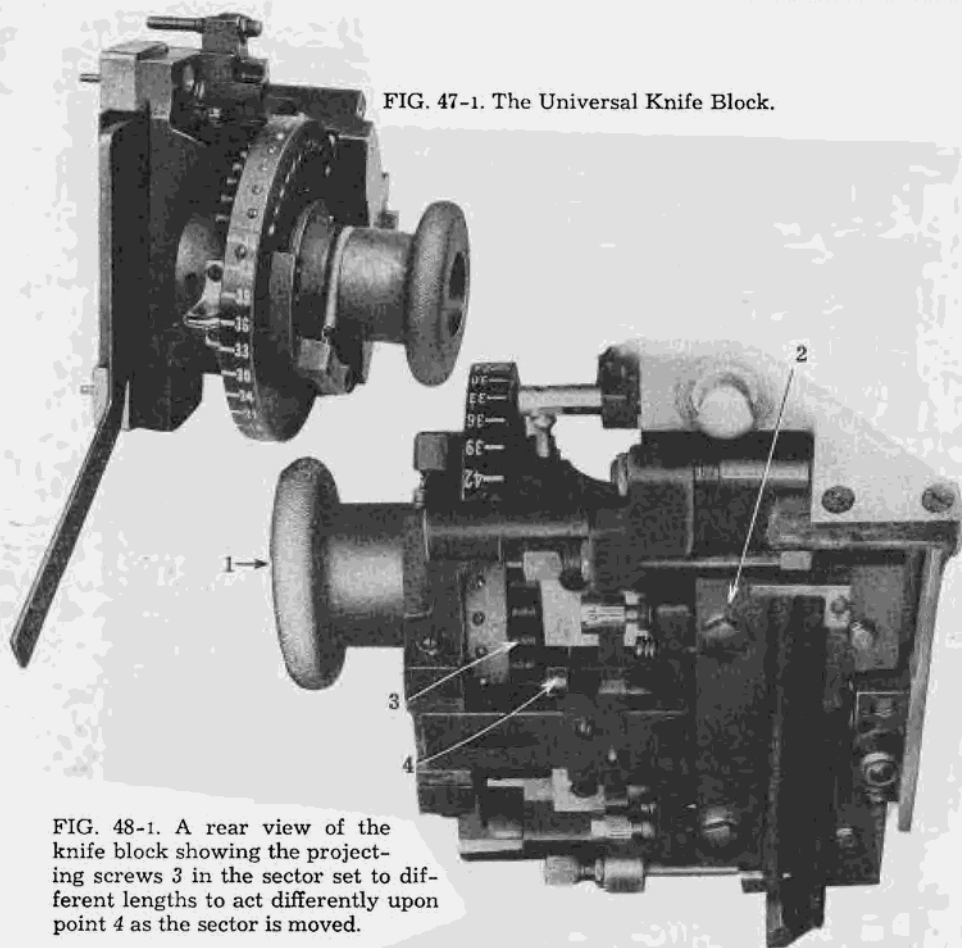

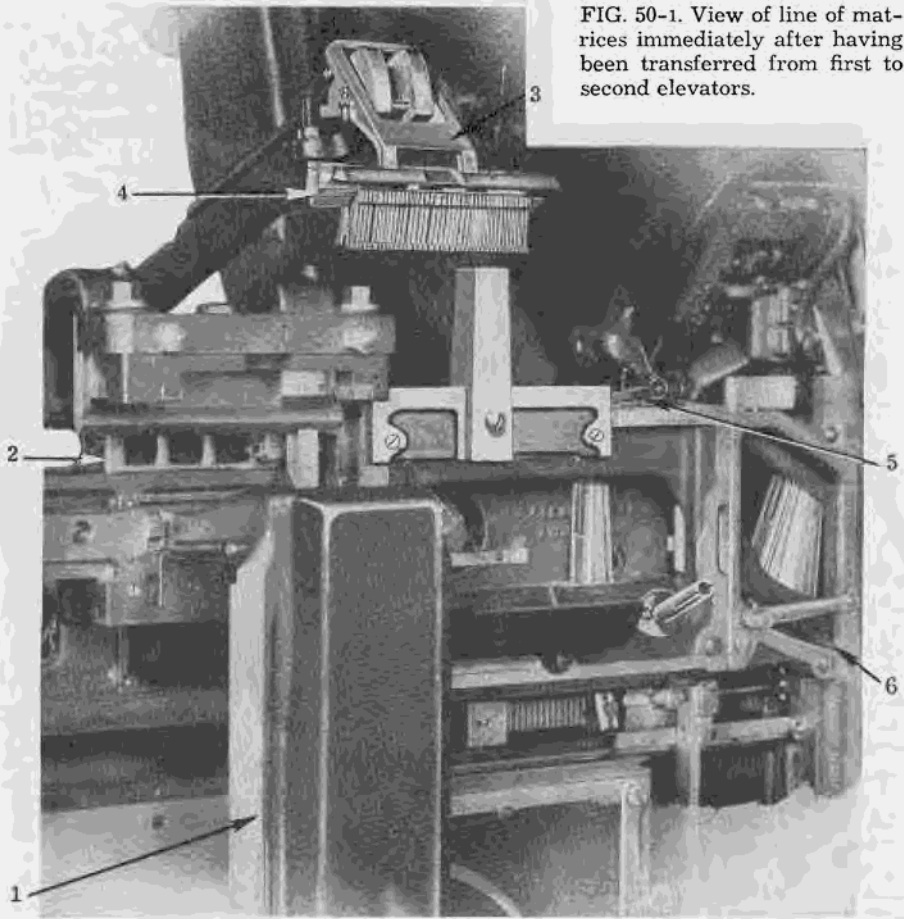

FIG. 50-1. View of line of matrices immediately after having been transferred from first to second elevators.

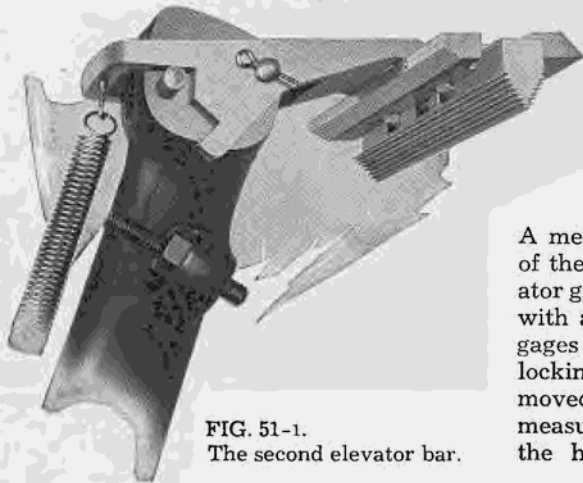

FIG. 51-1.  
The second elevator bar.

keeps the first elevator from descending full distance, all of the lines being cast in the auxiliary position. This device is called the Simple Two-Letter Attachment.

The vise jaws, Fig. 37-1, have to vary in separation to accommodate lines of different lengths. A method is provided for easy changing of the distance between them. The operator grasps the adjusting bar handle 4, and with a simple upward movement disengages the adjusting rod grooves 2 from locking block recesses 3. The rod 1 is then moved to the left or right to the desired measure, when a downward movement of the handle 4 locks the adjusting rod

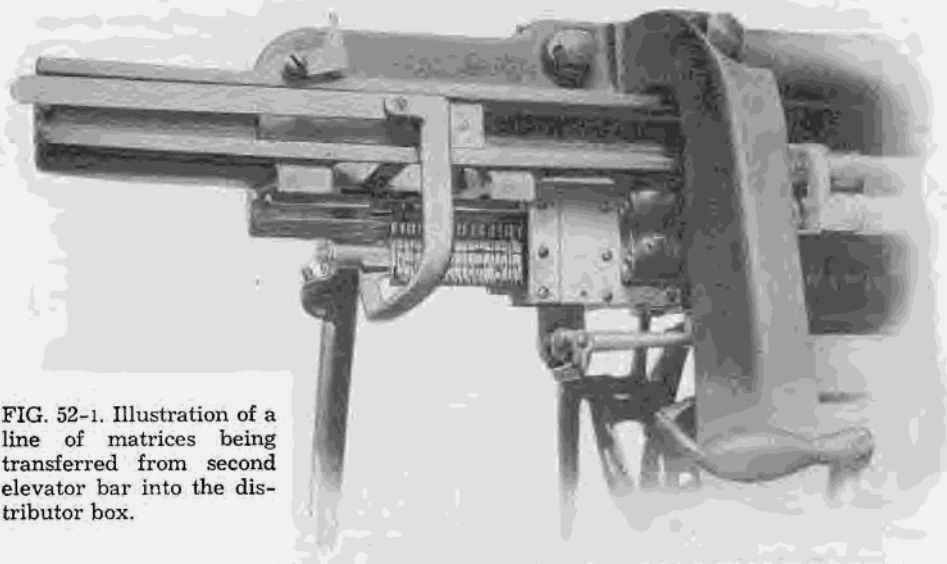

FIG. 52-1. Illustration of a line of matrices being transferred from second elevator bar into the distributor box.

grooves in the locking block recesses 3. The adjusting rod 2, on which the vise jaw 5 banks, is on a dead center line of both right- and left-hand jaws, which insures the left-hand vise jaw facing up squarely with the line of matrices.

This convenience, known as the Quick-Change Left-Hand Vise-Jaw Attachment, gives positive and accurate control of the jaw.

Directly below the jaw is the justification bar 6, which rises against the lower ends of the spacebands and wedges them, so that the word-spacing is spread until the line is full width.

The view as shown at 1 on Fig. 38-1 is partly in section and illustrates the relationship of the matrices to the mold.

The vise-automatic stop, shown at 3, is illustrated in Fig. 39-1 following.

The justification bar, which wedges the spacebands, is illustrated in Fig. 37-1.

The Universal Knife Block is shown in Figs. 47 and 48-1.

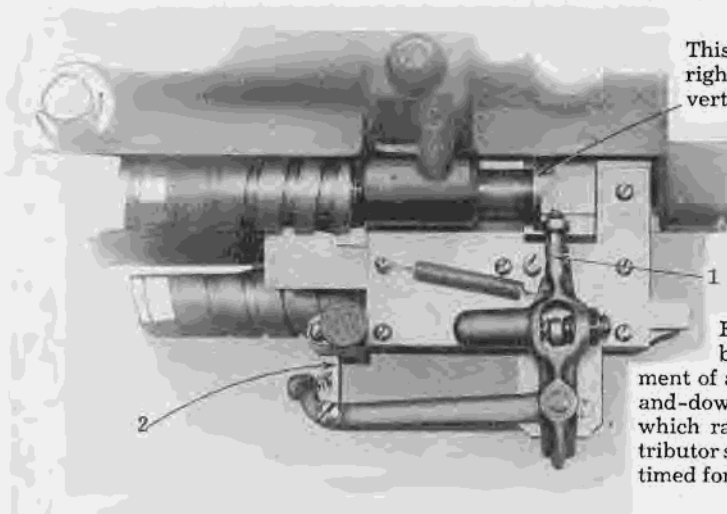

This cam causes periodic right-and-left motion of small vertical arm 1.

FIG. 53-1. The distributor box. Right-and-left movement of arm 1 is converted into up-and-down motion of the lifter 2, which raises matrices into the distributor screws at intervals correctly timed for spaces between matrices.



FIG. 54-1. Automatic font distinguisher.

When the machine is operating under normal conditions adjusting screw 1, Fig. 39-1, comes in contact with the end of automatic rod 2, pushing it down far enough so that plunger 3 can be pushed over a pawl 4 by the action of mold disk coming forward.

If the operator happens to overset a line and the elevator does not descend far enough, the plunger 3 comes in contact with the small pawl 4, which is held up by a spring, and the lower end of rod 2 pushes against a connecting lever which shuts off the casting mechanism and prevents the line from casting.

The metal from which Linotype slugs are cast can be melted and kept heated to the proper temperature by gas, electricity, gasoline or kerosene.

An illustration in cross section of the gas-heated metal pot is shown in Fig. 40-1. The electric pot is shown in Fig. 41-1.

When a line of matrices and spacebands has taken its place in front of the mold disk as shown at 1 in Fig. 40-1, the metal pot advances slightly until it touches the back of the mold which is in use, then the plunger in the center well is forced down, and the mold and the indented characters in the matrices which close the front of the mold slot are filled with molten metal. The metal solidifies—resulting in the Linotype slug.

To keep the metal at an even heat, hour in and hour out, all day, a simple thermostatic governor is provided. Linotype pots are completely cased in by a non-conductor to keep the heat in and to protect the metal.

One important feature of the Linotype pot is the method by which metal is drawn from the crucible proper into the center well. When the plunger rises, the molten metal is drawn through two holes in the sides of the well. The surface of the molten metal is hardly disturbed by this process—it remains practically intact, and there is a minimum of oxidation of the elements of the metal, especially of the tin, the most expensive of these elements and the most easily oxidized. Furthermore, this method insures that only clean metal is drawn into the well.

Another distinctive feature of Linotype metal pots is their exclusive mouth-piece, shown in Fig. 44-1.

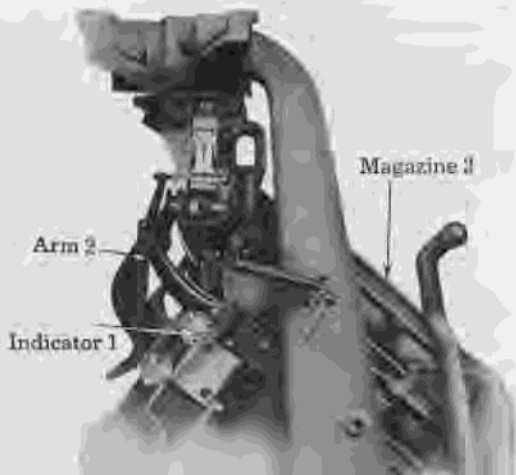
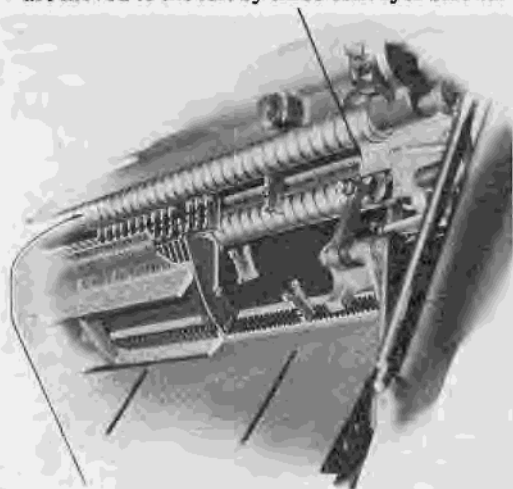

FIG. 55-1. View of font distinguisher shows how the position of the arm 2 determines the front-to-back position of the vertical knife-like projection in the bottom of the distributor box.

Matrices leave distributor box at this point and are moved to the left by three conveyor screws.



Each matrix is moved along by these screws to a point at which the corresponding teeth on the bar are cut away and cease to support it. It drops at this point into the correct channel of the magazine below.

FIG. 56-1. Illustration of matrices being distributed.

Fig. 41-1 is a cross-section view of the Linotype Electric Metal-Melting Pot equipped with Lino-Therm heaters and Micro-Therm control of temperatures.

Linotype melting pots hold 44 pounds of metal. As molten metal is used for casting slugs, bars of metal may be fed into the pot by means of an automatic feeder as shown in Fig. 42-1, or smaller pigs of metal may be fed into the metal pot by hand.

The electric pot has many advantages over the gas pot. It has no flame and no products of combustion. Furthermore, it is possible with the electric pot to regulate the temperature much more closely. Close regulation of the temperature of the molten metal greatly improves casting conditions and the resultant slugs.

Electric heaters are immersed in the metal, other heaters snugly contact the throat and mouth of the crucible—exactly where heat is

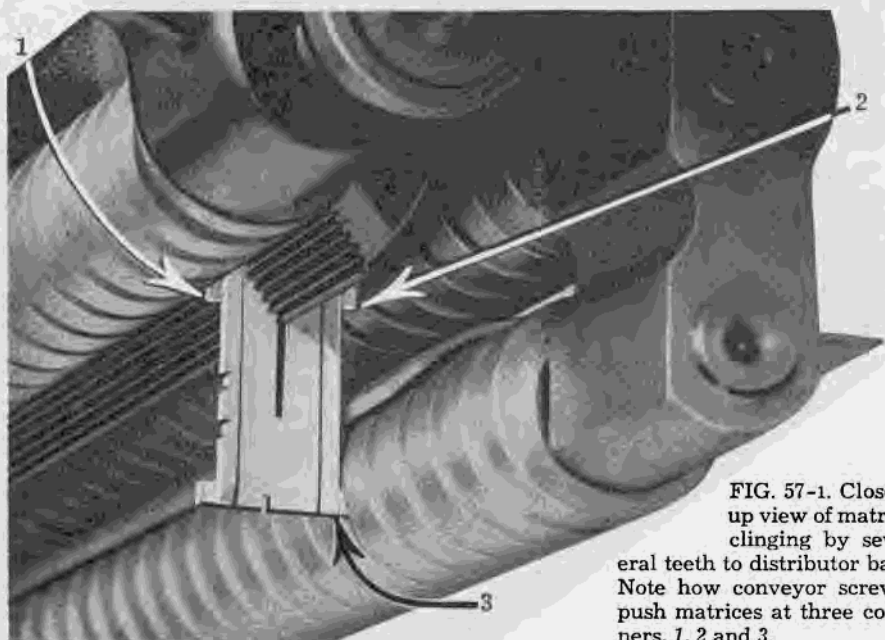

FIG. 57-1. Close-up view of matrix clinging by several teeth to distributor bar. Note how conveyor screws push matrices at three corners, 1, 2 and 3.

required and where the application of heat is of greatest efficiency.

Two automatic controls govern the temperature of the molten metal. One regulates the temperature of metal in the crucible; the other regulates the temperature at the mouthpiece.

A time-clock attachment may be had which will start the heaters at a certain time in the morning so that the metal will be ready for casting when the operator reports for the day's work.

Fig. 43-1 illustrates another example of how the Linotype is made "better than human." If the operator does not set a line of matrices and spacebands full enough, there is, of course, an uncovered section of the mouth of the mold through which molten metal may escape. The device is designed to prevent this.

The right-hand vise-jaw has a little "play." Unless the line of matrices and spacebands is full enough to move the right-hand jaw to its stop, it will not operate the arm which locks the pump lever and will not permit the plunger to descend and cast the slug.

The mouthpiece of a Linotype metal pot can be taken off by removing a few screws. The use of wedges, with resulting leakage and possible damage to the mouth of the pot, is obviated.

This mouthpiece serves all thicknesses of slug, either text or display.

As the mold disk, Fig. 45-1, revolves from its casting position to the position for ejection, the mold containing the slug passes the back knife 1 which trims the bottom of the slug to make it type high.

There must be some way to "eject" the slug from the mold after it is cast.

Obviously, since the slug is apt to be of any length up to 30 picas, some method must be established for varying the length of the blade by which the slug is pushed forward out of the mold. Linotype's ejector is *universal* for all thicknesses and lengths of slugs. Fig. 46-1 illustrates the inside structure of the Linotype Universal Ejector.

The old-fashioned way was to provide the operator with an assortment of blades of different lengths, so that when he desired to change ejectors, he could do so only with the expenditure of considerable time.

Now, all that the operator has to do is to move a handle and watch the indicator 2. By moving the handle 1 up or down, he moves indicator 2 up or down, and also bar 3. The higher bar 3 is, the more blades are pushed forward, and the longer the slug that may be ejected. The blades 4 move between plates which brace them firmly on both sides, thus giving them rigidity and preventing bending.



FIG. 58-1. View of the sorts stacker for pi matrices.

In addition to ejecting the slug from its mold, these blades also push the slug through a pair of shaving knives which trim it true on the sides.

When the newly cast slug comes from the mold, it may have a few small projections, so to make sure that it will be absolutely smooth and true on the sides, it is passed between two knife-edges which trim it clean and parallel. This movement is accomplished by the ejector blades on the same stroke with which the slug is forced from the mold.

After this trimming, the slug slides into the galley on the front of the machine. Then the slug is finished and ready for use.

Now, since the Linotype casts slugs from 5 to 45 points in thickness, there must be some way to vary the distance between the trimming knives.

This adjustment is easily made on the Linotype by the Universal Knife Block pictured in Figs. 47 and 48-1. A simple turn of the knob 1 causes the right-hand knife 2 to move from the left to right or back.

The screws 3 in the sector (20 in all) are independently adjustable. For example, the screw which determines the knife trim at 8 point can be "let out" a bit so that the 8-point slugs will be trimmed a trifle "full," or turned in to result in a "close" trim. This is sometimes desirable for effects in spacing between lines.

The Linotype galley shown in Fig. 49-1, in which the work of the Linotype is deposited, is inclined to a degree best adapted to permit the greatest speed and efficiency in the delivery of slugs regardless of the length and body size.

The descent of the slug is arrested by spring tension hook 1, allowing it to fall gradually on leather buffer 2, which, in turn, prevents damage or burring at the end of slug.

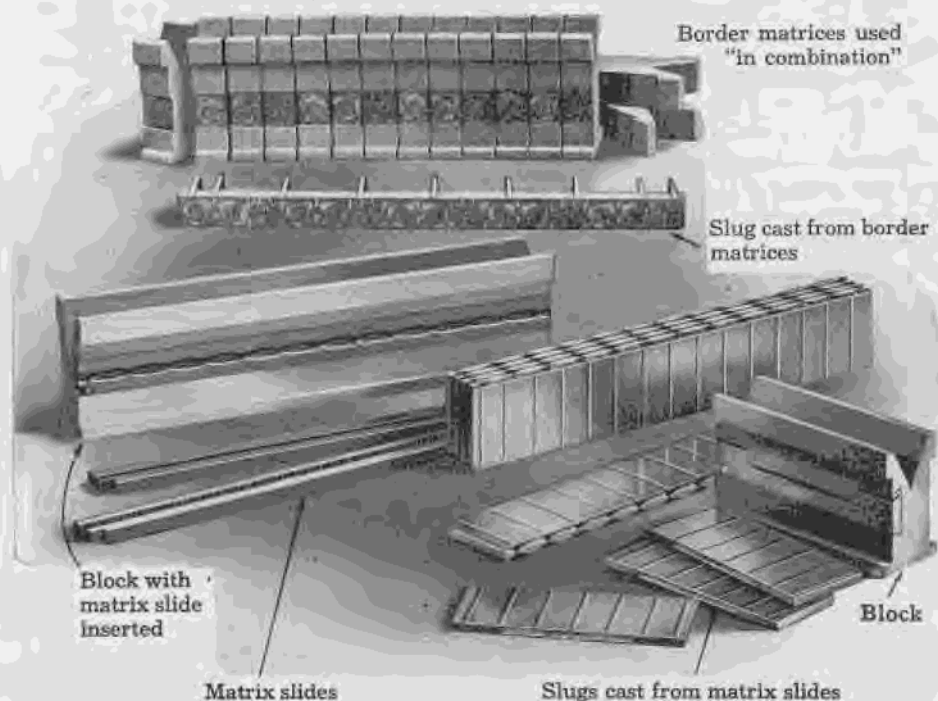

FIG. 59-1. Border matrices, matrix slides, and slugs cast from them.





FIG. 60-1. Several styles of racks are available, for storage of various combinations of extra magazines, either full-length, split or auxiliary.

The slug lever, 3, automatically advances the slug on the galley, while the pressure of spring tension hook 1 prevents any tendency of the slug to fall backward and thus interfere with delivery of the next slug.

The matrices have done their work and are now on their way home to the magazine, as shown in Fig. 50-1. The first elevator 1 has lifted them up from the casting position, the slide 2 has pushed the matrices to the right onto the second elevator bar, and the second elevator 3 has now started to lift them up toward the top of the magazine into the channels of which they will be dropped by the ingenious distributing mechanism.

The second elevator has a V-shaped bar 4, with teeth on it which engage the teeth of the matrices which are held there until they are transferred from the second elevator into the distributor box.

Since the spacebands have no such teeth, they are left on a track and a metal finger 5 engages their ears and pulls them into the spaceband box 6 where they are ready to be used again.

Fig. 51-1 shows the "hand" on the end of the long arm of the second elevator. Its most important part is the toothed V bar on which the matrix teeth engage.

This hand has to have great flexibility. When down, it must fit into an exact line with the first elevator jaw so that the matrices will slide accurately onto the V bar. Their teeth align with the teeth of the bar.

When up, it must fit into an exact line with the V bar of the distributor box, shown in Fig. 52-1, so that the matrices can be moved from one V bar to the other.

After the second elevator carries the matrices up they are pushed into this small box, known as the distributor box and shown in Fig. 53-1.

At the left end of this box is a lifter which rises at regular, evenly timed intervals. When this lifter rises it lifts the matrices one at a time to be carried onto the long distributor bar by the screws of the distributing mechanism which carries them home to their proper channels of the magazine.

This lifter is so timed that it keeps the matrices far enough apart to prevent them from interfering with each other as they drop into their respective channels.

Fig. 54-1 shows an arrangement (see Fig. 55-1 also) by which the machine automatically distinguishes between the different point sizes. It can be easily set for the sizes required, so as to admit matrices of one size into the first magazine, of another size into the second magazine, etc.

In the bottom of the distributor box there is a short knife-like vertical projection *I*, which can be moved from front to back. Unless the notches in the bottom of the matrices match the projection, the matrices cannot pass through the distributor box, and the distributing mechanism is stopped. This prevents 8 point matrices, for instance, from being distributed into a magazine of 6 point matrices.

As the magazines are raised or lowered, arm 2, as shown in Fig. 55-1, rests on one of the hexagonal indicators. If, for instance, arm 2 is resting on hexagon 1, the point-size of matrices admitted into the magazine 3 will be determined. By turning hexagon 3, the operator can decide the point-size of matrices to be admitted to magazine 3. There is one hexagon for each magazine. They are pivoted off-center, so that each of their six sides affects 2 in a different manner.

The teeth in the V-shaped end of the matrices are arranged differently for different characters, similar to the teeth on Yale keys. The various teeth combinations of matrix and bar make it possible for the matrices to find their proper magazine channels automatically.

The teeth hold the matrices suspended from the teeth on the distributor bar. When a matrix arrives at a point where the distributor bar teeth which have been supporting it are cut away, it drops into the magazine channel from which it originally came. (See Fig. 56-1.)

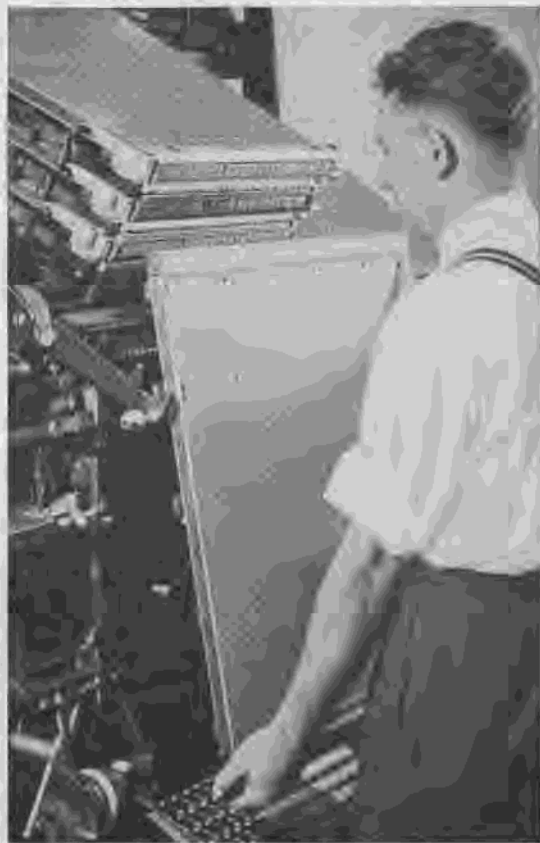

FIG. 61-1. Illustration showing method of changing magazines.

In this way the matrices are used over and over again continuously.

The conveyor screws are actuated through a clutch at the right end which automatically disengages when there is any resistance at any point along the screws. If for any reason a matrix should become "stuck" anywhere along the line, this automatic cessation of the conveyor movement prevents damage to matrices or conveyor mechanism.

If the operator wishes to use special characters or sorts, such as algebraic figures or fractions, in such small quantities as to make the use of channels in a magazine undesirable, the sorts stacker shown in the lower portion of Fig. 58-1 may be used for those "seldom-used" characters.

Such sorts are fitted with a tooth combination which causes them to ride the entire length of the distributor bar and drop off at the end of it—into the flexible metal tube at the right of the machine, shown in Fig. 58-1.

After the matrices pass through the tube they are stacked by means of a belt-driven elliptical star wheel, onto an inclined shelf. A sliding stop holds the matrices erect, in position to be easily available for further use.

In casting rules, borders and other ornamental and decorative material such as that shown in Fig. 59-1, it is possible to use, instead of a number of matrices, a matrix slide block into which has been slipped a matrix slide containing the desired rule, border, or decorative design.

One matrix slide block may be used for any number of different matrix slides, and expenditure thus reduced. Slides may be had in a great variety of lengths and point-sizes; blocks, in lengths as desired.

After the slide has been inserted in the block, the block is placed in casting position in the first elevator jaw. As many slugs as desired can be produced from one slide by recasting.

Many border designs can be easily and quickly cast from Linotype border matrices, and the matrices can be used in various combinations.

Substitution of either full-length, three-quarter length or split magazines is accomplished with a minimum of effort. All changes are made from the front of the machine, eliminating lost time and motion.



FIG. 62-1. The Linotype can grow as its owner's business grows. For instance, a Model 31 may be bought with one magazine, and three other magazines added later.

Magazine additions, as indicated in Fig. 62-1, can be made in the composing room by any operator. No dismantling or discarding of old parts is necessary, nor is the assistance of an expert machinist required.

In this discussion, "The Big Scheme of Simple Operation" or "What The Linotype Is," no reference has been made to the many time-saving and cost-cutting features available on Linotypes.

Rather, the thought has been to confine the foregoing discourse to an explanation of the fundamentals of the Linotype.

Sales literature and chapters of Linotype Machine Principles cover fully such Linotype features as the Self-Quadder, Six-Mold Disk, Optic-Aid Front, Blue Streak Shift, Micro-Therm Heat Control, Thermo-Blo Mold Cooler, Linotype Auto Ejector, Quick-Opening Knife Block, and the many other Linotype features.

## *How the Big Scheme Fits Plant Needs*

**E**MBODYING the principles of construction and operation outlined in these pages, Linotypes are designed in several models to meet different requirements. The variations in these models are simple in principle. The fundamental classifications in Linotype machines include single distributors, plural distributors or "mixers," and super-display Linotypes.

Single distributor Linotypes compose from and distribute matrices to one magazine at a time. Such machines may carry, for convenience, as many as four main magazines and up to four auxiliary magazines.

Plural distributors are nick-named "mixers" because they compose matrices from two or more magazines simultaneously and distribute continuously to the plural assortment of magazines. Thus roman, italics, and small capitals may be mixed at will in the same line with bold face or other contrasting characters from other magazines. The procedure is continuous with automatic distribution of the lines of mixed matrices back to the proper magazines.

Super Display Linotypes, equipped with wide-standard magazines, are made both as single distributors and mixers. The former are made with either 90-channel or 72-channel magazines (which are 5¾ inches wider than standard magazines), while the mixers are available with either 90-channel, or with 90- and 72-channel wide-standard magazines combined in the same machine.

The various kinds of Linotypes are available with main magazines (from one to four as desired) and with added auxiliary magazines (likewise from one to four). Within their classifications of channel capacities and widths these magazines are interchangeable on all current models of Linotypes.

The "two-in-one" principle, available in all Linotype mixer models, provides for the use of both 90-channel and 72-channel magazines in the same machine, with corresponding mold equipments. This facilitates the setting of text and display matter on one machine, thus frequently providing for more economical handling of composition requirements.

How to use any or all of these facilities to the utmost profitable advantage in any plant is the question which men of Linotype, the world over, are prepared to answer as veritable composing-room engineers. They, too, are part of the big scheme of simple operation.

This booklet is set in Linotype  
Textype, and printed direct from  
the slugs. The display is in the  
Memphis Medium series, with  
title lines on the cover set in  
Linotype Memphis Extra Bold.

Printed in U. S. A.

611.01.2-A-MM-75Z

**INSIDE  
BACK  
COVER**



TRADE **LINOTYPE** MARK