

UNIVERSITY OF TORONTO

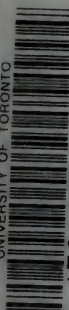

3 1761 01291715 9

Digitized by the Internet Archive
in 2007 with funding from
Microsoft Corporation

(48)

7
45

592 ~

TURNING
AND
MECHANICAL MANIPULATION.

VOL. IV.

BY

JOHN JACOB HOLTZAPFFEL,

ASSOCIATE MEMBER OF THE INSTITUTION OF CIVIL ENGINEERS, LONDON; PAST MASTER OF THE
WORSHIPFUL COMPANY OF TURNERS; EXAMINER, CITY AND GUILDS OF LONDON
INSTITUTE FOR THE ADVANCEMENT OF TECHNICAL EDUCATION, ETC.

VOL. I.

MATERIALS; THEIR DIFFERENCES, CHOICE, AND PREPARATION; VARIOUS
MODES OF WORKING THEM, GENERALLY WITHOUT CUTTING TOOLS.

VOL. II.

THE PRINCIPLES OF CONSTRUCTION, ACTION, AND APPLICATION, OF CUTTING
TOOLS USED BY HAND; AND ALSO OF MACHINES DERIVED
FROM THE HAND TOOLS.

VOL. III.

ABRASIVE AND MISCELLANEOUS PROCESSES, WHICH CANNOT BE
ACCOMPLISHED WITH CUTTING TOOLS.

VOL. IV.

THE PRINCIPLES AND PRACTICE OF HAND OR SIMPLE TURNING.

VOL. V.

THE PRINCIPLES AND PRACTICE OF ORNAMENTAL OR COMPLEX TURNING.

VOL. VI.

THE PRINCIPLES AND PRACTICE OF AMATEUR MECHANICAL ENGINEERING.

Every Volume to be complete in itself.

TURNING
AND
MECHANICAL MANIPULATION.

INTENDED AS

A WORK OF GENERAL REFERENCE AND PRACTICAL INSTRUCTION,

ON THE LATHE,

AND THE VARIOUS MECHANICAL PURSUITS

FOLLOWED BY AMATEURS.



VOL. IV.

THE PRINCIPLES AND PRACTICE OF HAND OR SIMPLE TURNING.

*Illustrated by upwards of Seven Hundred and Fifty Woodcuts, drawn on the wood
by the Author.*

BY

JOHN JACOB HOLTZAPFFEL,

ASSOCIATE MEMBER OF THE INSTITUTION OF CIVIL ENGINEERS, LONDON;

PAST MASTER OF THE WORSHIPFUL COMPANY OF TURNERS;

EXAMINER, CITY AND GUILDS OF LONDON INSTITUTE FOR THE ADVANCEMENT
OF TECHNICAL EDUCATION, ETC.

TO BE COMPRISED IN SIX VOLUMES.

109483
27.4.11

LONDON:

PUBLISHED FOR THE AUTHOR,

BY HOLTZAPFFEL & CO., 64, CHARING CROSS, AND 127, LONG ACRE.

And to be had of all Booksellers.

1881.

SECOND THOUSAND.

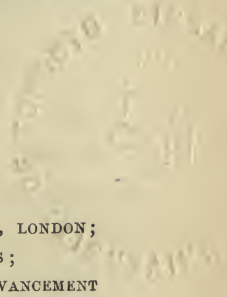



THE
LONDON
AND
WINDSOR
PRINTING
WORKS



LONDON:
BRADBURY, AGNEW, & CO., PRINTERS, WHITEFRIARS.

BRADBURY, AGNEW, & CO.
PRINTERS, WHITEFRIARS.

PREFACE

TO THE FOURTH VOLUME.

IN submitting the Fourth Volume of Turning and Mechanical Manipulation to the indulgence of the public, the Author respectfully begs leave to offer a few words upon this continuation, so constantly demanded by numerous friends and patrons, of his father's widely known and justly celebrated work.

It has always been the Author's earnest desire to produce the present volume, and force of circumstances alone has compelled postponement. A reference to the irreparable loss he sustained at a very early age, in the death of his highly gifted father, may be excused, as that loss obviously involved a long lapse of time for the attainment of adequate experience ; with time, came the continued, active conduct of a business more than usually dependent upon close individual attention, no slight obstacle, while notwithstanding a statement in the preface to the first edition of the third volume, but withdrawn from subsequent editions, to the effect that a portion of the fourth was in print, all progress for the furtherance of the work made by his late father proved to have terminated with the third and posthumous volume.

A word of explanation is due to those who possess the edition referred to. The pages it was at one time proposed to utilize had been written for a smaller, and prior to the

conception of the more extended work ; subsequent and reliable judgment determined that they could not be in harmony with the published volumes, the idea was regretfully abandoned and the copies destroyed.

The Author recognizes the grave responsibility incurred in following the complete knowledge and able workmanship displayed in the preceding volumes, and is fully sensible of the comparisons, just and inevitable, his attempt must challenge. In writing the fourth volume, he has in the first instance followed the outline laid down for it in the general sketch of the contents of the complete work, absolutely ; while in working out the detail of the wide range of subjects comprised in plain turning, he trusts that without neglect of or undue length in any, he may have succeeded in producing a companion volume not entirely unworthy of association with the first three, one also both elementary, and yet containing sufficiently advanced information, to render it acceptable to the amateur and others who follow the art of turning.

Information upon all matters spoken of in the first three volumes as deferred for consideration to the fourth, has it is hoped in every case been carefully given, and will be found on reference to the index. The Author trusts to receive lenient judgment for any shortcomings, and in order that they may receive future correction, he relies on the kindness of his readers to bring to his notice, ambiguous expressions, errors or omissions, from which, in spite of his exertions to the contrary, he can scarcely expect the fourth volume to be entirely free.

64, CHARING CROSS, LONDON.

21st October, 1881.

GENERAL SKETCH
OF THE
CONTENTS OF THE WORK.

VOL. I.

MATERIALS, THEIR DIFFERENCES, CHOICE, AND PREPARATION; VARIOUS
MODES OF WORKING THEM, GENERALLY WITHOUT CUTTING TOOLS.

Introduction—Materials from the Vegetable, the Animal, and the Mineral Kingdoms.—Their uses in the Mechanical Arts depend on their structural differences, and physical characters. The modes of severally preparing, working, and joining the materials, with the practical description of a variety of Processes, which do not, generally, require the use of Tools with cutting edges.

VOL. II.

THE PRINCIPLES OF CONSTRUCTION, ACTION, AND APPLICATION, OF CUTTING
TOOLS USED BY HAND; AND ALSO OF MACHINES DERIVED
FROM THE HAND TOOLS.

The principles and descriptions of Cutting Tools generally—namely, Chisels and Planes, Turning Tools, Boring Tools, Screw-cutting Tools, Saws, Files, Shears, and Punches. The hand tools and their modes of use are first described; and subsequently various machines in which the hand processes are more or less closely followed.

VOL. III.

ABRASIVE AND MISCELLANEOUS PROCESSES, WHICH CANNOT BE ACCOM-
PLISHED WITH CUTTING TOOLS.

Grinding and Polishing, viewed as extremes of the same process, and as applied both to the production of form, and the embellishment of surface, in numerous cases to which, from the nature of the materials operated upon, and other causes, Cutting Tools are altogether inapplicable. Varnishing and Miscellanea.

VOL. IV.

THE PRINCIPLES AND PRACTICE OF HAND OR SIMPLE TURNING.

Descriptions of various Lathes;—applications of numerous Chucks, or apparatus for fixing works in the Lathe. Elementary instructions in turning the soft and hard woods, ivory and metals, and also in Screw-cutting. With numerous Practical Examples, some plain and simple, others difficult and complex, to show how much may be done with hand tools alone.

VOL. V.

THE PRINCIPLES AND PRACTICE OF ORNAMENTAL OR COMPLEX TURNING.

Sliding Rest with Fixed Tools—Revolving Cutters, used in the Sliding Rest with the Division Plate and Overhead Motion. Various kinds of Eccentric, Oval, Spherical, Right-line and other Chucks. Ibbetson's Geometric Chuck. The Rose Engine, and analogous contrivances, &c. With numerous Practical Examples.

VOL. VI.

THE PRINCIPLES AND PRACTICE OF AMATEUR MECHANICAL ENGINEERING.

Lathes with Sliding Rests for metal turning, Self-acting and Screw-cutting Lathes—Drilling Machines—Planing Engines—Key-groove, Slotting and Paring Machines—Wheel-cutting and Shaping Engines, &c.

With numerous Practical Examples.

*** The First, Second, and Third Volumes of this work, are written as accompanying books, and have one Index in common, so as to constitute a general and preliminary work, the addition to which of any of the other volumes, will render the subject complete for the three classes of Amateurs referred to in the Introductory Chapter.*

A few additional copies of the Index have been printed for the convenience of those who may desire to bind the Index with Vols. I., II. and III.

The First, Second, and Third Volumes of this work, are written as accompanying books, and have one Index in common, so as to constitute a general and preliminary work, the addition to which of any of the other volumes, will render the subject complete for the three classes of Amateurs referred to in the Introductory Chapter.

A few additional copies of the Index for Vols. I, II., and III., have been printed for the convenience of those who may desire to bind an Index with every volume.

TABLE OF CONTENTS

OF THE FOURTH VOLUME.

CHAP. I.—INTRODUCTION.

	PAGE
The circular form—Earliest known instances of turned works and the lathe—Probable derivation of reciprocatory motion from the drill, as used by the Egyptians and other Ancient peoples, and still employed	1
SECT. 1. <i>The Indian, Persian, Arabian, and other lathes. The Chinese lathe.</i> The simple construction of these lathes, driven by the bow—Instances of the continued use of these primitive machines.—Superior arrangement of the parts of the Arabian lathe—Mode of use. Examples and illustrations of elaborate meshrebeeyeh work, wrought in this lathe. Spanish and South American lathes of similar formation. Chinese reciprocating lathes driven by the feet	5
SECT. 2. <i>European lathes with reciprocal motion, from poles, springs and bows.</i> Difference from the Eastern, and varying forms of the earliest pole lathes.—Schopper's Pole lathe. Moxon's, and his description—Back rests to support the operator.—Plumier's and other later lathes, some driven by the archery spring bow.—Instances of the continued and present use of the pole lathe.—Watch and clock makers, reciprocating lathes and "turns;" driven by the hand bow.—Continuous direction of motion in the pole lathe	16
CHAP. II.—CENTER LATHES WITH CONTINUOUS MOTION.	
SECT. 1. <i>Introduction of the wheel. Hand wheels.</i> The Potter's throw, driven by the foot and by hand.—The hand wheels of Schopper. Moxon. Bergeron and others	29
SECT. 2. <i>Foot wheels</i> —Their tardy adoption, and inefficient early construction.—Moxon's foot wheel, and his remarks thereon.—Various positions given to the foot wheel.—Plumier's and Bergeron's, modes of construction and attachment.—The foot wheels made of wood, and the gradual change to the present forms	31
SECT. 3. <i>The driving wheel considered as to momentum and as a speed pulley. Varieties of hand fly wheels.</i> Application, weight, and dimensions of foot and hand driving wheels. The Softwood turner's, Cutler's and other hand wheels.—The hand wheel applied in the clock throw. Various other dead center lathes	36
SECT. 4. <i>Cranks and treadles of foot lathes.</i> Attachment of the fly wheel.—Single and double throw cranks. Crank hooks, centers and bearings. Early and modern forms of treadles. Exceptional forms.—Clement's and other treadles	45

	PAGE
SECT. 5. <i>Driving lines and bands. Splicing and couplers.</i> Varieties and dimensions of driving bands.—Instructions for joining them by splicing,—and for the attachment of hooks and eyes.—Nicholls' hooks and eyes.—Frequent variation in the length of catgut bands.—Various modes of reeving the driving bands, and the employment of tension pulleys	51

CHAP. III.—LATHES WITH REVOLVING MANDRELS.

SECT. 1. <i>Mandrels mounted in wooden headstocks.</i> Mandrels first made of wood, described by Felibien and others.—Iron mandrels then cased in wood.—Early traversing mandrels, used for screw cutting.—Plumier's method of construction.—The mandrel mounted in metal collars.—A later French screw mandrel lathe.—Construction of its traversing mandrel.—English, back center mandrel and collar plate. The Tunbridge screw mandrel	58
SECT. 2. <i>Bar and bed lathes.</i> Wooden bearers.—Triangular iron bar lathe.—The iron bar, compared with rectangular iron bearers.—Sections of iron lathe bearers.—Torsion.—Extension of the triangular bar lathe. Various forms of gap and break lathe bearers, used by the engineer	65
SECT. 3. <i>Mandrels mounted in metal headstocks.</i> The lathe head formed in one piece.—Forms and advantages of modern back center mandrels and collars.—Modern traversing mandrels.—Engineer's lathe heads and mandrels.—Fox's, Clement's and other mandrels.—Tail pin or stay to take the pressure in boring.—Derivation and various forms of back gearing for reduction of speed—Gearing applied to the face plate, and reversed single speed cones applied in a lathe by Nasmyth for the same purpose	72
SECT. 4. <i>Driving and countershafts.</i> Driving straps and belts.—Stepped pulleys.—Millwright's lying shaft and tension pulleys.—Modern driving and countershafts.—Fast and loose pulleys.—Variation of speeds from complementary pulleys and back gearing—From single cone pulleys, applied by Bodmer and others—Their use in the potteries.—Comparison of the early and modern methods of communicating power	84

CHAP. IV.—MODERN FOOT LATHES.

INTRODUCTION.

SECT. 1. <i>Lathes with plain or back center mandrels.</i> Dimensions of foot lathes.—Plain lathe head, construction of the mandrel, collar and back center.—Face of the mandrel and that of the chuck—Lubrication—The plain popit head—The hand rest—Wood bearers, and single framed lathe.—Iron bearers, and single wood frame—Cylinder popit head, centers and flange. Iron framed lathes	91
SECT. 2. <i>Lathes with traversing or screw cutting mandrels.</i> Construction of the screw mandrel lathe head—Screw guides and conducting apparatus.—Double framed lathes. Some advantages incidental to wood frames	106

PAGE

SECT. 3. *The slide foot lathe.* Used principally for larger and heavier work.—General description and details of its various portions.—Mandrel and back gearing—An exceptional form of the latter, in internal geared lathe pulleys.—Main screw.—Slide rest and change wheels.—Clutch box.—Traverse given to the fly wheel and partially balanced treadles 110

CHAP. V.—APPARATUS ADDED TO THE LATHE FOR SPECIFIC PURPOSES.

SECT. 1. *The Division plate and Index—Scribing tools.* Various forms of Division plates and plain Indexes—Method of using the division plate—Adjusting Indexes, and their purposes—The Counting Index for the prevention of errors—Table of ordinary divisions of the Circles, usually placed on the Division plate—The Adjusting Index used for prime numbers, by the method of interpolation.—Simple methods of marking the divisions on the work.—The dividing tee and the dividing gate for more accurate purposes 118

SECT. 2. *Boring collars—Sliding guides and backstays.* Varieties of Boring collars, for large and small works, in wood and metal—Adjustment of the boring collar, for turning and drilling—Simple guides or supports for long works of small diameter—The hand, wedge and stick—Simple mechanical supports—Adjustable guides for wood, ivory and metal, and their application—Backstay used with the ornamental slide rest—Backstays for the slide lathe, used in turning and screw cutting 128

SECT. 3. *The Slide rest, Slide rest tools—Manipulation and adjustment.* Slide rests for plain turning with two and three slides.—Wear—Slide rest tools and cutter bars for wood and metal turning—Position of the tool and its adjustment to height of center.—Vibration.—Traverse and depth of cut in wood and metal turning—Remarks on using the slide rest in plain turning—First adjustment of the slide rest to turn the accurate cylinder and surface, and the tests employed . . 137

SECT. 4. *Apparatus added to plain lathes for cutting screws and spirals—The Spiral apparatus—Surface spiral—Atkinson's Reciprocator.* Screws obtained by bands and pulleys, and remarks thereon—Apparatus used by Spiral balustrade turners—Bands and pulleys used for the regular traverse of the slide rest—Star wheel and more comprehensive arrangements for the same purpose—Comparison of the Slide lathe and the Spiral apparatus—Different arrangements of the Spiral apparatus—Details of the chuck, radial arm, and arbors; and their application—Table of Settings for Screw threads, resulting from one toothed wheel on the mandrel, and one on a slide rest screw of ten threads to the inch—Mode of calculating trains of wheels—Table of Screw threads, resulting from the exchange of the single arbor or intermediate wheel, for a pair of wheels on one arbor—Tables of Settings for screw threads, with a main screw of four-threads to the inch. Interposition of a second pair of wheels on one arbor, or by the Surface Spiral apparatus—The application of the latter to cylinders, surfaces and curved forms—Table of Settings for

	PAGE
coarse and surface spirals with the foregoing—Multiplex threads—Driving the Spiral apparatus—Details of Atkinson's Reciprocator, and its application to surfaces, cones, curves and cylinders	152
SECT. 5. <i>Lifting blocks and lengthening bearers.</i> Small, and more considerable increase given to the height of center, for the lathe heads and slide rests. Temporary appliances to obtain additional length for turning shafts and rods	179

CHAP. VI.—CHUCKS AND APPARATUS FOR FIXING THE
VARIOUS WORKS IN THE LATHE.

INTRODUCTION.

General remarks upon lathe chucks, their diversity of form and purpose. Division of the chucks into four principal groups or sections for convenience of description	185
--	-----

CLASSIFIED AND DESCRIPTIVE INDEX OF THE CHUCKS AND
APPARATUS.

SECT. 1. <i>Chucks for long objects supported at both ends, the popit head always required.</i> Prong chucks used for wood the lengthway of the grain—Adjustment of the work to center—Flange chucks with points, for larger works—Taper fluted chucks—Square hole chucks for wood and metal—Instructions for setting and centering metal work—Forming the center in the work—The Sliding center; Kilburn's, and Hall's centering tools—Driver or Running center chucks, with pointed and hollow centers; exclusively and extensively used for metal—Various forms of Carriers attached to the work—Loss of equilibrium, counteracted by the Ring carrier—Backlash—Clement's Double Self-acting Driver chuck, for correction of an incidental error—Centering cranks and eccentric works—Scribing tools for marking base lines—Examples of works turned from many centers	189
SECT. 2. <i>Long objects supported at one end only.</i> Square and round hole drill chucks—Pad and boring bit chucks—Arbor chucks for cutters for metal and for carving—Hollow chucks with pinching screws, principally for metal, and instructions for adjusting the work—Die chucks with two slides—Die chuck with one slide—Instructions for their use, with the work placed axially or eccentrically—Bennett's Die chuck, comprehensive and preserving equilibrium—Mordan's, and Beach's Die chucks for round wires—Die chuck with split dies for round and other forms	205
SECT. 3. <i>Chucks for short objects, grasped by their edges.</i> <i>Chucks without loose parts.</i> Plain, cup, or driving chucks—Their convenient qualities and various application—The hammer—Plain wood chucks, for partially completed works—The larger sizes, mounted on metal flanges—Angle of fitting—External and internal rebates—Instructions for chucking, rechucking, verification, and unchucking—Plain metal chucks with wood and lead stoppers, used for wood, ivory and metal turning. <i>Chucks with loose parts.</i> Wood spring chucks	

	PAGE
and their application. Various forms of metal spring chucks and their incidental advantages—Bennett's and other spring chucks—Chucks the converse of the preceding—Brunel's Expanding Arbor—Hick's, Yuile's, and other Expanding mandrels—Double cone expanding mandrel—Universal chucks with three slides and jaws, moved simultaneously—Dundas' Universal or Scroll chuck—Universal chucks with two jaws moved simultaneously—Surface chucks with dogs; and examples of the application of all the foregoing .	213
SECT. 4. <i>Chucks for short objects, fixed against one of their surfaces.</i> Screw worm chucks, used for wood the plankway of the grain. Double screw chucks, holding the work by the external and internal screws, that subsequently affix its parts to one another. Screw arbor chucks—Arbor chucks with cone—Professor Willis' Disc chuck—Cement chucks for wood and metal, and instructions in their various applications—Surface chucks for metal and the varieties of clamps and bolts—Application of the foregoing surface chucks to a wide range of works in wood and metal.—Instructions for fixing circular, rectilinear and various other shaped works, centrally and eccentrically—Precautions against inaccurate results—Upright chucks for wood and metal, for turning portions of the work at angles to the general axis—The Surface chuck and fixing blocks, and instructions for turning works from many centers	236

CHAP. VII.—THE ELEMENTARY PRACTICE OF SOFTWOOD TURNING.

SECT. 1. <i>Introduction—Position for Standing. Treading the lathe. Velocity given to the work.</i> Treatment of the subject, followed in this and the succeeding elementary chapters—General remarks upon the matters in this section	254
SECT. 2. <i>External tools. Leverage. Position of the gouge and chisel on the Cylinder. Callipers.</i> The softwood gouge, chisel, flat and parting tools.—The turning tools considered as levers.—The manner in which they are held and presented to the work.—The cutting bevils tangents to the circle formed—Various callipers and their application	257
SECT. 3. <i>Position of the gouge and chisel on the Surface, Back Surface, the Plankway surface and on the Cone.</i> Turning the surface the length way of the grain—The cutting bevils co-incidental with the plane formed—Turning the corresponding back surface—The parting tool—Different manipulation of the tools on the surface, the cylinder and curves, turned the plankway of the grain—Cones and conical surfaces	267
SECT. 4. <i>The Internal cylinder, Boring, Internal softwood tools. Hollowing with the gouge, hook and side tools. The Internal surface.</i> The smaller internal cylinders and plain fittings made by boring—Larger by turning—Striking a center, for all internal tools, and the tools used in boring—The softwood hook and side tools, or internal gouges and chisels—Hollowing cylindrical work with the gouge—Manipulation followed and unique position of the tool—Hollowing	

	PAGE
with the hook tools and completing the internal cylinder with the side tools—Instructions in using these tools—Rough turning and finishing the internal surface with the hook and side tools, and with the broads—The internal cone	278
SECT. 5. <i>The Sphere and internal hemisphere.</i> Consideration of the angular positions and path of the tool on the softwood sphere—The smaller spherical forms, produced directly from the cylinder by the gouge and chisel—Larger or superior results produced with the same tools, guided on the polygonal system—Manipulation and precautions followed in turning the softwood sphere—Gages—Turning the internal hemisphere, with the gouge, or with the hook tool	288
 CHAP. VIII.—THE ELEMENTARY PRACTICE OF HARDWOOD AND IVORY TURNING. 	
SECT. I. <i>Hardwood and ivory tools. Position and cutting action.</i> Their action more usually that of scraping tools—The gouge generally, and the softwood tools sometimes employed—The different tools for hardwood and ivory with rectilinear cutting edges—Those with curvilinear cutting edges—The “horizontal position,” and the manner in which the tools are presented to the work—Cutting action of the tools cutting by their ends, and that of those cutting by their side edges—Leverage and pressure	294
SECT. 2. <i>The Cylinder and Surface. The Armrest.</i> The gouge and flat tool on the cylinder—Vertical inclination or tilt—Other tools available—Rough turning the surface with the gouge, point and other tools—Horizontal inclination of the edge of the tool—The armrest, and the manner in which it is used for surface turning in various materials	302
SECT. 3. <i>Boring and turning the Internal cylinder. Internal surface, and internal parting tools.</i> Wire drills, pipe bits and twist drills, used for boring the smaller internal cylinders—Cylinder bits for larger and accurate apertures—The manipulation of the foregoing—The apertures enlarged with the turning tool—Turning and finishing internal cylinders of various dimensions—Turning the internal surface and tests employed—The turning square—The parting tool used for internal cylinders cut completely through the work—The employment of inside parting tools, to remove and preserve the material from within cylinders closed at one end	310
SECT. 4. <i>External and internal cones.</i> Manipulation of the tools and material, in rough turning and finishing—Conical curved shapes	320
SECT. 5. <i>The Sphere and internal hemisphere.</i> Chucking the material, and production of the sphere on the polygonal system—First the one and then the other hemisphere—Re-chucking the work to turn the one true with the other—Manipulation of the tools—Hollowing and finishing the internal hemisphere, and curves of greater sweep—Analogous and converse curves upon the cylinder—Ring gages employed for the foregoing	321

CHAP. IX.—ELEMENTARY METAL TURNING.

	PAGE
SECT. 1. <i>Introduction. Tools in common use for turning steel, iron and brass. Preparation of the material. Speed and depth of cut. Lubrication. Advantages derived from previous practice in turning wood—The graver, triangular, flat, point and hook tools for iron and steel—The router, flat, round, point, square and milling tools for brass—Burring and preparing castings and forgings—Annealing—Variations of speed, depth of cut, and lubrication, required by the material and dimensions of the work</i>	328
SECT. 2. <i>Manipulation of the hand tools upon cylindrical forms in metal. Diamond tools. Position of the tools in turning iron and brass—Instructions in turning cylindrical work in iron—Methods and precautions in turning similar forms in brass and gun-metal—Parallelism—Applications of the flat file in cylindrical turning, and other methods of finishing, and of polishing—Examples of cylindrical and surface turning—Hardened steel turned with the diamond—Manipulation, and various forms of diamonds used for this and other purposes of turning</i>	338
SECT. 3. <i>Manipulation of the hand tools upon surfaces and surface forms in metal. Instructions in turning the surface in iron and brass.—Precautions necessary with the latter—The tools generally supported on the armrest—The flat file employed upon surface works</i>	350
SECT. 4. <i>Metal cones, cylindrical and surface curves. Conical centers and fittings—Tapering forms merging into curves—Examples of works of long and other curves of the cylindrical character—Small curvatures and edges—Burnishers—Instructions in burnishing various forms in steel, iron and brass—Examples of curved outlines in works of flat section, produced by turning</i>	354
SECT. 5. <i>Internal cylinder and surface. Sequence, or consecutive character of processes in metal turning. Methods of turning deep and shallow metal cylinders and their accompanying surfaces.—Illustrations of the succession of steps followed in metal turning</i>	360

CHAP. X.—SCREW CUTTING.

SECT. 1. <i>Introduction. Striking and chasing screws with the hand tools. Screws employed for fixing portions of the work to one another, and others—Characters of the screws cut upon different materials—Forms of the hand screw tools—The manner in which these produce the screw upon the work—Elementary practice in striking and chasing external screws—Form given to the work, and manipulation in cutting external wood screws, for practical purposes—Elementary practice in striking and chasing internal wood screws—The same for practical purposes—Cutting metal screws with the hand tools—Double and other threads</i>	367
SECT. 2. <i>Similar screws cut with the traversing mandrel. The mechanical certainty of this arrangement—Manipulation of the mandrel and screw guides—The treadle and fly wheel, in relation to the position of the hand screw tools on the rest—Cutting and finishing external</i>	

	PAGE
and internal screws with the hand tools—Adjustment and manipulation of the tools when used in the slide rest—Softwood screw tools, used with the traversing mandrel—Wood screws, cut with the screw box	377
SECT. 3. <i>Screw cutting with the Slide lathe or Spiral apparatus.</i> For long and accurate screws—Tools and Cutter Bars employed for external, angular and square threads—Inclination of the tool to the angle or rake of the thread—Geometrical method of ascertaining the angle—Ames' Chord dividers—Loss of time between change wheels, and other parts of the apparatus—Separation of the driver and carrier—Form and preparation of blanks for angular threaded screws—Adjustment, trials, and manipulation of the tool and slide rest, in cutting an angular external thread—Speed and depth of cut—Various interferences met with—Re-adjustment of the tool—Cutting external square threaded screws—Internal screw threads—Tools and Cutter bars for internal threads—Taps—Cutting internal screw threads—Cutting metal screws with multiplex threads	333
SECT. 4. <i>Chuck and similar screws, tapped and then cut in the lathe.</i> Lathe taps, and analogous tools used with the double screw chucks—Instructions in using the lathe taps in wood chucks—and in cutting the screws in the metal chucks—The necessary accuracy of the system followed—Importance of axial truth and parallelism	399
 CHAP. XI.—THE SPHERE, AND VARIOUS FORMS IN HARD- WOOD AND IVORY DERIVED FROM THIS SOLID. 	
SECT. 1. <i>Selection and preparation of the material.</i> Changes of form in wood, arising from contraction with and across the grain—Varying density—Contraction and variation of density in ivory—Suitable and unsuitable section—Billiard ball ivory—Selection and preparation of ball blocks	406
SECT. 2. <i>Chucking and turning the billiard ball and accurate sphere.</i> Preliminary rough turning in wood and ivory—The revolution of the circle upon its diameter, employed as the gage in producing the sphere—Necessary concentric truth in the chucks—Direction of the grain, marking the circumference, and "banding" the billiard ball—Instructions for adjusting the rough ball in the chuck, with the plane and the diameter of its circumference, both, true with the mandrel axis—Manipulation of the gouge and chisel in turning the first hemisphere—Correction of the result—Turning the second hemisphere; which is necessarily true with the first—Rechucking the ball upon different axes, for the gradual correction of small errors, inseparable from the first turning—Verification of the sphere—Simplicity and accuracy of the process—Polishing billiard balls	413
SECT. 3. <i>Various works formed within the sphere by plain turning.</i> The surface of the sphere serving as gage, and all the following turned with the hand tools alone. Instructions for turning the Chinese ball—Setting out the centers—The Chucks and tools employed—Ornamenting the surfaces of the shells—Instructions for turning	

	PAGE
compound solids within the sphere—The Singapore ball—Tools and gages employed for turning circular solids within spherical envelopes—The method followed—The five regular solids—Setting out the equi-distant centers of their four, six, eight, twelve and twenty planes, upon the surface of the sphere—These divisions serviceable for other purposes—Manipulation in turning the faces of the polyhedra—The same solids separated into shells, contained one within the other—Compound forms turned within polyhedral envelopes	426

CHAP. XII.—PRACTICAL EXAMPLES OF SIMPLE PLAIN TURNING IN WOOD AND IVORY.

SECT. 1. <i>Construction, form and ornament.</i> Simple and combined plain turning—Reasons for constructing most turned works in several pieces fitted together—Convenience in manipulation—Strength—Contrast in colour—Economy of material—Relative size of the various designs drawn and described—Outline considered as to its balance or proportion—Unavoidable variations—Enrichments, as to their forms, positions and number; their relation and subordination to outline—Examples of the correct position of ornament in various columns, pedestals and other forms—The employment of ornament to conceal joints and to relieve monotony—Where indispensable—Proportion in mouldings—The forms of mouldings and their members, most applicable to turning—Contrast, repetition and variety—Consideration of the source of outline in the Greek and Etruscan vases—Comparison of curved outlines obtained from the circle, the ellipse and the oval	446
--	-----

TABULAR VIEW OF WORKS IN PLAIN TURNING IN WOOD AND IVORY.

SECT. 2. <i>Axial or simple plain turning.</i> Examples in hard and softwood, from single pieces of material turned between centers—Turning long and quick curvatures, etc.—Sequence observed in turning these to definite forms and positions—Glass paper, its manipulation, precautions against its abuse—Instructions in various methods of polishing softwood, hardwood and ivory—Plain typical forms—Designs for <i>Egg cups, Salt cellars, Spill and Flower holders</i> , and their production in good shapes from single pieces of material—Designs for <i>Ash trays, Bottle stands, Pin and Toilet trays</i> —Sequence followed in turning the foregoing, the lengthway and the plankway of the grain—Chucking, and precautions for truth and security—Designs for <i>Flour and Sugar Sifters, String boxes, Toilet boxes and Bouquet holders</i> —Simple examples formed of more than one piece—Fitting the various portions together as plain joints—Contraction in plain fittings—Designs for <i>Candle sticks and Wax taper holders</i> —Their construction in wood and ivory—Designs for <i>Vases and pedestals, Banner screens and Candle shades</i> —Designs for turning, copies of <i>Greek and Etruscan vases</i> —Their production on a large or small scale in wood or ivory	460
---	-----

CHAP. XIII.—PRACTICAL EXAMPLES OF COMBINED PLAIN TURNING. EXECUTED WITH THE HAND TOOLS ALONE.

	PAGE
SECT. 1. <i>Various specimens of moderate dimensions. Attachment and formation of columns, arcs of circles and other ornamental forms.</i> More ornamental typical forms—Various designs for <i>Watch Stands</i> —Columns—Methods of inserting portions parallel with, or inclined to the general axis of the main figure—Turning rings of plain and ornamented sections, to form the arch, and the various employment of their segments—Designs for <i>Candle shades</i> and for <i>Inkstands</i> —Construction of the foregoing—Attachment of arcs of circles, forming tripods, supports and feet—Designs for <i>Vases with turned handles</i> —Construction and methods of attaching turned and shaped handles—Designs for an <i>Amphora</i> —Formation of its tripod support, and turning a triform plinth—Designs for <i>Temples</i> —Their construction from several pieces of similar or contrasting material—Chucking and turning the <i>Dome</i> and <i>Entablature</i> —Examples of screwed double fittings—Columns, capitals, bases and pedestals	499
SECT. 2. <i>Specimens generally larger, and for useful purposes. Plain turning applied to surface ornamentation.</i> Various designs for <i>Menu holders</i> and <i>Stands for China</i> —Some plain and simple, others formed of many assembled pieces—Designs for <i>Table-ware</i> and their formation—The construction of clustered columns—Designs for <i>Epergnes</i> , carrying flower vases, glass and china bowls—Construction of the various pieces of these more ornamental examples—Arms and branches—Design for a <i>Tripod Jardinière Stand</i> —Examples of turned work, assembled and attached to flat surfaces—Designs for <i>Wall Mirrors</i> and <i>Brackets</i> —Instructions for producing works of this class—The Gothic arch, columns and pendants—Design for and construction of a larger <i>Wall Mirror</i> —Eccentric ornament in plain turning—Cement and surface chucks, tools, and methods employed—Turning discs enriched with trefoils, quatrefoils, cinquefoils and other eccentric ornament—Inlaying discs and rings in various ways for surface and cylindrical ornamentation—Designs for and formation of <i>Chandeliers</i> and <i>Hanging Jardinières</i> , with branches—Enrichment of cylindrical and other edges by attached serrated and inserted ornament—Design for a <i>Candelabra</i> —Formation of its branches, stem with spirally arranged leaves, and triform base—Designs for <i>Tripods</i> , derived from <i>Pompeian models</i> , for <i>Flowers</i> , <i>Lamps</i> , <i>Statuettes</i> or <i>Vases</i> —Their construction, and producing all portions of the foregoing more elaborate works, by plain turning—Enlargement or reduction of designs or models—Proportional compasses and callipers	523

CHAP. XIV.—MISCELLANEA IN PLAIN TURNING IN WOOD AND IVORY. DYEING, STAINING AND DARKENING.

SECT. 1. <i>Miscellanea.</i> Solid turned shafts and other pieces, of mixed circular and rectangular section—Square pieces for plinths, etc., turned from the cylinder—Instructions for their production—The	
--	--

	PAGE
lengthway and the plankway of the grain—Turning cubes and prisms and attached ornament—Crosses with either two or more arms—The chucks and methods followed, in turning shafts and pedestals of square forms, contained by flat convex faces—The chucks and manipulation for the radial figuration, of solid cylindrical margins—Projecting or incised ornament, distinct or combined—Profile turning in the solid or in rings—The tools employed—Instructions for transparent plain turning in wood and ivory—Slender turning, applied as stems and supports for the foregoing—Examples of more elaborate slender turning—Mode of concealing addition to diameter of shafts, practised in furniture turning—Chucks and tools employed, and instructions for turning pipes, in wood, meerschaum and amber—Polishing amber and meerschaum .	551
SECT. 2. <i>Staining, dyeing and darkening.</i> General observations—The woods treated and the colours required—Preparation of stains and dyes, in water, spirit and oil—Instructions for darkening, colouring and bleaching, to obtain agreement in tone in specimens of similar woods—Methods followed for staining and for dyeing the woods—Staining and dyeing ivory—Preparatory treatment, and general precautions observed in dyeing this material—Preparation of the decoctions and solutions used, and their application in dyeing various colours in ivory	571

FULL PAGE ILLUSTRATIONS.

PLATE	PAGE
I.—DETAILS OF MESHREBEEYEH WORK.	12
II.—CAIRENE WINDOW.	13
III.—FOOT SLIDE LATHE.	111
IV.—FLOWER AND SPILL HOLDERS. SALT CELLARS	477
V.—SIFTERS, STRING BOXES, ETC.	481
VI.—BOUQUET HOLDERS, TOILET BOXES AND TRAYS	485
VII.—CANDLESTICKS AND TAPER STANDS	489
VIII.—VASES, BANNER SCREENS, CANDLE SHADES	493
IX.—GREEK AND ETRUSCAN VASES	497
X.—WATCHSTANDS. INKSTANDS. ETC.	501
XI.—AMPHORA. CANDLE SHADES. INKSTANDS.	507
XII.—VASES WITH HANDLES	511
XIII.—TEMPLES.	515
XIV.—STANDS FOR CHINA, ETC.	520
XV.—TABLE-WARE	521
XVI.—EPERGNE	525
XVII.—EPERGNES	529
XVIII.—WALL MIRRORS. TRIPOD	534
XIX.—WALL MIRROR.	535
XX.—CHANDELIERS. JARDINIÈRE	541
XXI.—CANDELABRA	545
XXII.—POMPEIAN TRIPODS.	549

TURNING

AND

MECHANICAL MANIPULATION.

VOL. IV.

THE PRINCIPLES AND PRACTICE OF HAND OR PLAIN TURNING.

CHAPTER I.

INTRODUCTION.

THE symmetrical beauty, and necessity of the cylindrical form to the wants of mankind, in an endless variety of utensils and implements, the daily requisites of civilization ; in the construction of the tools and machines for manufactures, locomotion, science, and the spread of knowledge ; are it is submitted too apparent to demand more than mere allusion, even in a volume devoted to its production by the practice of turning. Readily obtained in all materials, directly or indirectly in the lathe or some of its modifications ; the circular form has been always met with more or less exactly, appearing in many natural objects, such as the reeds and canes, in trees, flowers, fruits and seeds, in the egg, in pebbles, shells, and many animal structures. It may fairly be presumed therefore that its characteristics were appreciated and copied by the earliest races of mankind, and although we have no knowledge of the time and manner, in which the handicraft of turning arose and first progressed, it will be allowed that inferences on these interesting points, may be drawn from observation of several primitive lathes still used, and followed in other early but more advanced lathes, of which there exist records.

The practice of the art may be traced back to a very remote period, probably the earliest evidences being the numerous works that have been found among Egyptian antiquities, at Thebes and other cities ; very many of which exhibit indubitable signs that the material while in revolution, was subjected to the action of a tool held at rest. Among these, the legs of stools and chairs and other long objects, were probably turned after the same simple method now followed by the Indian and the modern Egyptian ; but it is curious, that among all the sculptured records of the trades and occupations, which so vividly represent the customs and habits of the ancient Egyptians, no example of the lathe has hitherto been met with. The potter and his wheel, however, are depicted in these sculptures, and they are frequently mentioned in the earliest writings ; this form of the lathe, which has received little material modification to our time, was doubtless employed for the production of much of the antique pottery left by early nations ; some of which, like the unrivalled vases of the Etrurians, attest unsurpassable taste and skill.

The lathe was undoubtedly commonly used by the Greeks and Romans ; among their authors both Cicero and Pliny refer to the turners or *vascularii*,* while Herodotus uses the lathe as a familiar simile. “ But I smile when I see many persons describing the circumference of the earth, who have no sound reason to guide them ; they describe the ocean flowing round the earth, which is made circular as if by a lathe ” (Herodotus, Book IV. Chap. 36. Cary.) ; but unfortunately, it appears that none of these nor other early writers have left us any account of the lathe and tools employed by their contemporaries. It would appear probable, that the origin of the lathe may be found in the revolution given to tools for piercing objects for ornament or use. At first, it may be supposed, that a spine or thorn from a tree, a splinter of bone or a tooth, was alone used and pressed into the work, as we should use a bradawl. The process would naturally be slow and unsuitable to hard materials, and this, probably suggested to the primitive mechanic, the idea of attaching a splinter of bone or flint to the end of a short piece of stick, rubbing which

* Vol. i., p. 5.

between the palms of his hands would give a rotary motion to the tool.

Increased range of motion with proportionate rapidity in the cutting or abrasion, would be obtained by wrapping a cord once or twice around the shaft and alternately pulling the ends; the opposite end of the tool revolving in the cavity of a shell or stone, held in the hand or placed against the chest. This would be the exact type of the reciprocating drill and drillbow, tools common to all nations and in every day use. And granting these few steps in procedure, the pole or bow lathe may easily have followed. The shaft of the drill tool has been assumed as supported at both ends and driven by the cord; it now only requires the supports to have been fixed and pointed, and a cutting tool to have been applied against the work while in revolution, for the arrangement to have become the type of all the different lathes with reciprocating motion.

An illustration of the early use of the drill and drillbow, fig. 1, taken from Rossellini's great work on the Egyptian and

Fig. 1.



Fig. 2.

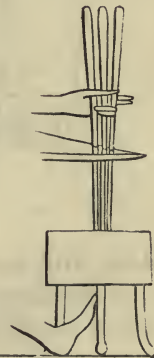

Nubian monuments,* distinctly shows the drill to be inserted in a wooden shaft, which has apparently itself been turned, having a spherical cap to which the pressure of the one hand

* I Monumenti dell' Egitto e della Nubia, illustrati dal Prof^e Ippolito Rossellini. Plates 44 and 52; vol. ii. Lib: Brit: Mus:

is applied, whilst rotation is produced by the bow held in the other. The spherical cap may also have been turned to shape, but it was sometimes a natural object, Sir Gardiner Wilkinson pronouncing some discovered, to have been made of the fruit of the don palm. Another of Rossellini's illustrations, fig. 2, shows the workman to be piercing three small holes close together by a rather unusual method; the drills are separated by the fingers of the left hand and the bowstring envelopes them in succession, the pressure being now given by the weight of the enlarged mass at the top of each.

A different contrivance for giving the drill reciprocal motion, probably as ancient, fig. 3, is used by the Chinese, and obtains also to some extent among ourselves. The drill stock passes freely through a hole in a cross staff, from either end of which a single string is carried through an eye, pierced at the top of the drill shaft, above which is a weight or bulb of metal to give momentum. The operator first coils the string

Fig. 3.



Fig. 4.

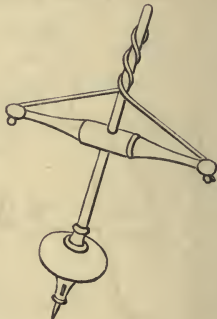

around the drill shaft, the shortening of the string causing the ascent of the cross staff; he then sharply depresses the cross staff, which uncoiling the string turns the drill as many times as there are coils. The pressure by the hand is only given at the first moment of the descent of the cross staff, but the momentum continues the motion, and winds up the string in the opposite direction, ready for the succeeding stroke. This old form of drill is used by the glass and china menders for piercing the holes for the insertion of the small metal staples called rivets, afterwards cemented in position. Other artizans

occasionally employ this *pump drill*, but in Europe, the weight is usually shifted to the lower part of the spindle, fig. 4, to lessen the disposition to upsetting.

It may be surmised, that the Indian or Eastern nations were among the earliest to follow the art of turning, and that later, their method of practising the art was carried by the Arabian and Moorish nations, to the furthest extent of their conquered territories; while thence from Spain it was transported to South America. The strong analogy that exists between the lathes used in the present day, by the Hindoos, the Persians, the large group of Moslems, the Spaniards and some of the South American nations, proving this to be far from hypothetical; and the same turning lathe appears to have remained in use by these peoples without considerable improvement, from its early rude construction until now.

It is unfortunate that so little is known of the early history of the lathe in Europe, but it would appear probable that the exchange of the sitting for the upright posture of the operator, as more congenial to the habits of the European, must have soon led to important modifications in the construction of the apparatus. The greater elevation of the lathe, thus permitted the introduction of the pole and various attempts at improvement in that method of giving motion. The pole lathe and the bow lathe, of both of which we have descriptions in the earliest known work exclusively on turning,* were eventually superseded by the lathe with continuous rotatory action; but the former is still valuable and remains in use for some purposes. During the last century the development and improvements in the lathe and its congeners have been rapid and continuous, always keeping at least equal pace with the increased requirements of the time.

SECTION I.—THE INDIAN, PERSIAN, ARABIAN, AND OTHER
LATHES. THE CHINESE LATHE.

The lathe found in use among the natives of India, fig. 5, still remains the same primitive apparatus that has been con-

* *L'Art de Tourneur ou de faire en perfection toutes sortes d'ouvrages au Tour*, par le R. Père Charles Plumier, Religieux Minime. First edition, folio, Lyons, 1701; second edition, folio, Paris, 1749.

sidered as the probable starting point of turning. The practice is as follows;—when any portion of household furniture has to be turned, the wood turner is sent for; he comes with all his outfit and establishes himself for the occasion at the very door of his employer. He commences by digging two holes in the ground at a distance suitable to the length of the work, and in these he fixes two short wooden posts, securing them as strongly as he can by ramming the earth and driving in wedges and stones around them. The centers, scarcely more than round nails or spikes, are driven through the posts at about

Fig. 5.

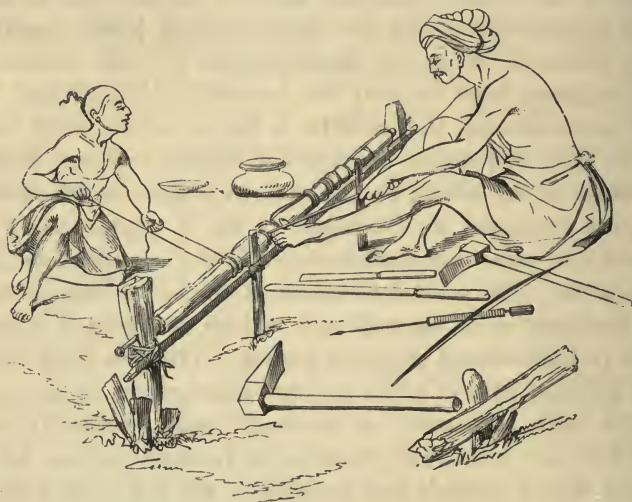

eight inches from the ground, and a wooden rod for the support of the tools, is either nailed to the posts or tied to them by a piece of coir or cocoa-nut rope. The bar, if long, is additionally supported as represented, by being tied to one or two vertical sticks driven into the ground. During most of his mechanical operations the Indian workman is seated on the ground, hence the small elevation of the axes of his lathe. The boy, who gives motion to the work, sits or kneels on the other side of it holding the ends of the cord wrapped around it in his hands, pulling them alternately; the cutting being restricted to one half of the motion, that of the work towards the tool. The turning tools of the Indian are almost confined

to the chisel and gouge and their handles are long enough to suit his distant position, while he guides their cutting edges by his toes. He grasps the bar or tool rest with the smaller toes and places the tool between the large toe and its neighbour, generally out of contact with the bar. The Indian and all other turners using the Eastern method, attain a high degree of prehensile power with the toes, and when seated at their work not only always use them to guide the tool, but will select indifferently the hand or the foot, whichever may happen to be the nearer, to pick up or replace any small tool or other object.

The limited supply of tools the Indian uses for working in wood is also remarkable, they are of the most simple kind and hardly exceed those represented in fig. 5. The most essential in constructing and setting up his lathe being the small single handed adze, the Bassōlāh, referred to page 473, Vol. II. With this he shapes his posts and digs the holes, it serves on all occasions as a hammer and also as an anvil,

Fig. 6.



when the edge is for a time fixed in a block of wood. The outer side of the cutting edge is perfectly flat, and with it the workman will square or face a beam or board with almost as much precision as if it had been planed; in using the bas-sōlāh for this latter purpose the work is generally placed in the forked stem of a tree, driven into the ground as shown in the illustration.

The method followed by the Persian turner, fig. 6, is not quite so rude. In his lathe the centers are made to pass through the ends of an open box, the edge of which serves for the support of the tool; they are raised or lowered to suit work of different diameters in a series of holes pierced in a vertical line. Small works are set in motion by the bow, both by the Persian and Indian, for those of larger diameter, both use a cord pulled by an assistant; but, when using the cord the Persian lathe is fixed by means of stakes to prevent its being pulled along the ground. Excepting the portable box the turning apparatus and manipulation thus differ but little from those last described.

The lathe used by the Arabian and Moslem group of turners, is shown by fig. 7, drawn from a sketch by the author, made in 1873 in one of the numerous turners' shops in Cairo. The Arab's lathe although roughly constructed presents several improvements over those of his Eastern brethren; it is more complete and is adjustable to works of different lengths. The apparatus is formed of two wooden feet or cross pieces, about six inches square by three feet in length, carrying two iron centers towards their ends; a longitudinal wooden stretcher about five or six inches wide, is fixed to the left foot and passes through a corresponding mortice in the right, within which it can be fixed by a wooden wedge. When the work is fixed between the centers, the four parts form a rectangular frame, which the width of the longitudinal piece in great measure prevents from racking and retains moderately square. The tool rest consists of a heavy iron bar laid across the two feet, and is adjusted to the height of center by separate pieces of wood placed between it and the cross feet. The center points being adjusted to the length of the work and the stretcher fixed by the wedge, the machine is retained stationary whilst in use by four loose spikes, which pass through holes in the feet and are slightly driven into the floor.

The operator sits upon one heel, the toes of the foot going just under or upon the stretcher and he directs the tool, which he holds by a long handle, with the toes of the other foot; the position being much like that of the Indian fig. 5, except that the whole body is more compactly held together. Occasionally and for heavy work, both feet are advanced, placed close

together, and press the tool on the bar by the big toes, the other toes closely pressed around the tool and on the bar; while the latter is always pushed forward by the feet and withdrawn by the hands, as may be required to regulate its distance from the work.

The tool or the bow are held indifferently in either hand, as the work may render more convenient; but, the left hand and the right foot for the tool, with the bow in the right hand appears most general. The bow presents a peculiarity in the hinged piece near the handle, employed to regulate the tension of the string; the string is wrapped once or twice around the work, after which it is twisted round the jointed piece, which is then folded back and held in the hand with the handle. A stick is used for the support of long work of small diameter;

Fig. 7.

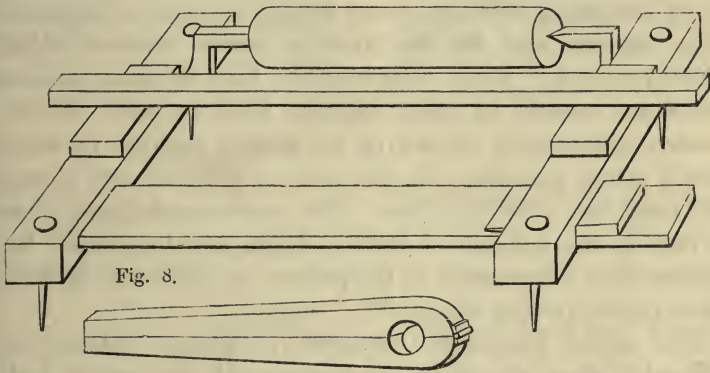

Fig. 8.



Fig. 9.

one end is placed beneath the stretcher and a wedge or rough piece of wood between the stick and the floor, forces the other end up to the work and opposes the thrust of the tool; the arrangement being analogous to the simple support fig. 132. When turning many pieces of one size, the Arab employs two slips of wood sometimes jointed together fig. 8, with an opening the size of the work. He uses the same contrivance for

internal turning and boring; one center point alone being used, the other extremity of the work being held in the circular aperture of the double bar. The Arab turner works nearly as much in public as the Indian, his workshop being a small square room, the front entirely open to the street, with the floor upon which he sits about three feet above the level of the road. He, also, will carry his lathe to his work, and it is his daily practice when the sun shines too powerfully, to quit his workshop, and carrying his lathe over to the opposite and shady side of the street, to establish himself on the ground in front of the shop of one of his neighbours; driving the spikes into the hard sand forming the road, to retain his lathe stationary.

The lathe, although of so rough a description, has been most effectively employed for centuries, for the production of a peculiar and very beautiful ornamental wood work, for the interior decoration of Mosques and houses, for screens, seats and other objects, and for the Arabian lattice windows called "Meshrebeeyeh." These oriel windows, have all those portions which are usually of glass, entirely filled by open, turned, wooden latticework, formed of an infinite number of small turned pieces something like the bails of a wicket, but jointed and fixed one into the other. The work is sufficiently close to impede the passage of light and sun and to conceal the inmates from observation by the passers by, while still allowing a free passage to the air.

The skilful handicraft displayed in these constructions, especially when viewed in connection with the simple tools employed, is so remarkable, as to merit a short notice. The lines of turned work are generally from one to two inches apart from center to center, the smaller parts all securely fitted together crossing and intermingling in all directions; while the larger beads or collars turned upon the spindle-like pieces, are frequently flattened on the sides, subsequently to the turning, giving additional variety in effect and reducing the surface nearly to a level.

Figs. 10 to 16 are drawn from portions of windows in the author's possession, and give some idea of the work, although but little of its real beauty. The pieces forming the lattice work are often arranged in fantastic patterns, and are sometimes

10.

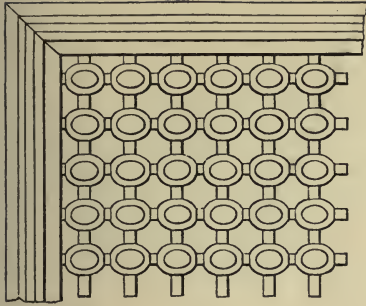

11.

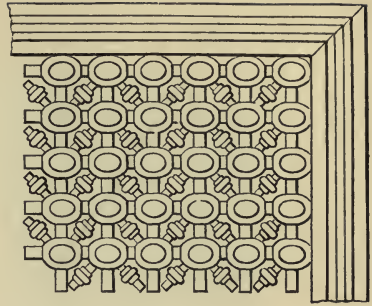

12.

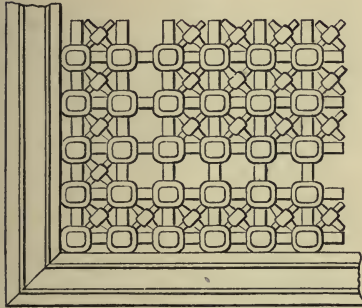

13.

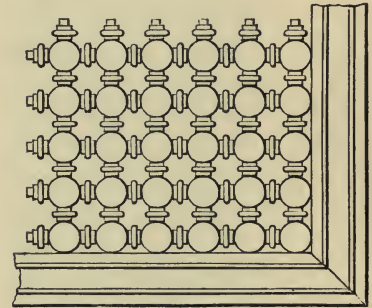

a.

14.

b.

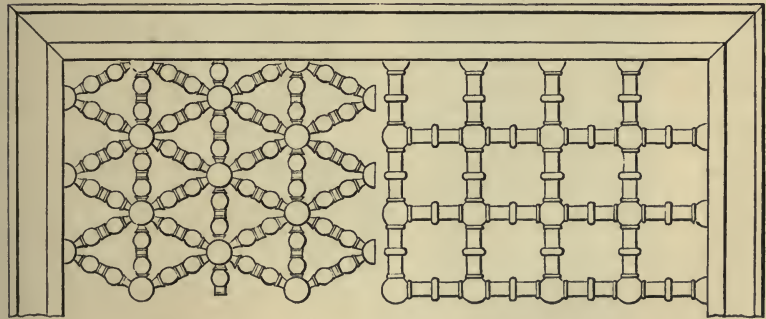

15.

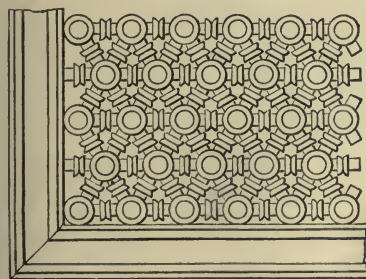

16.

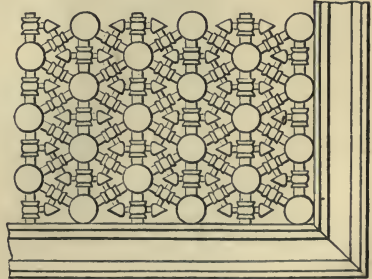

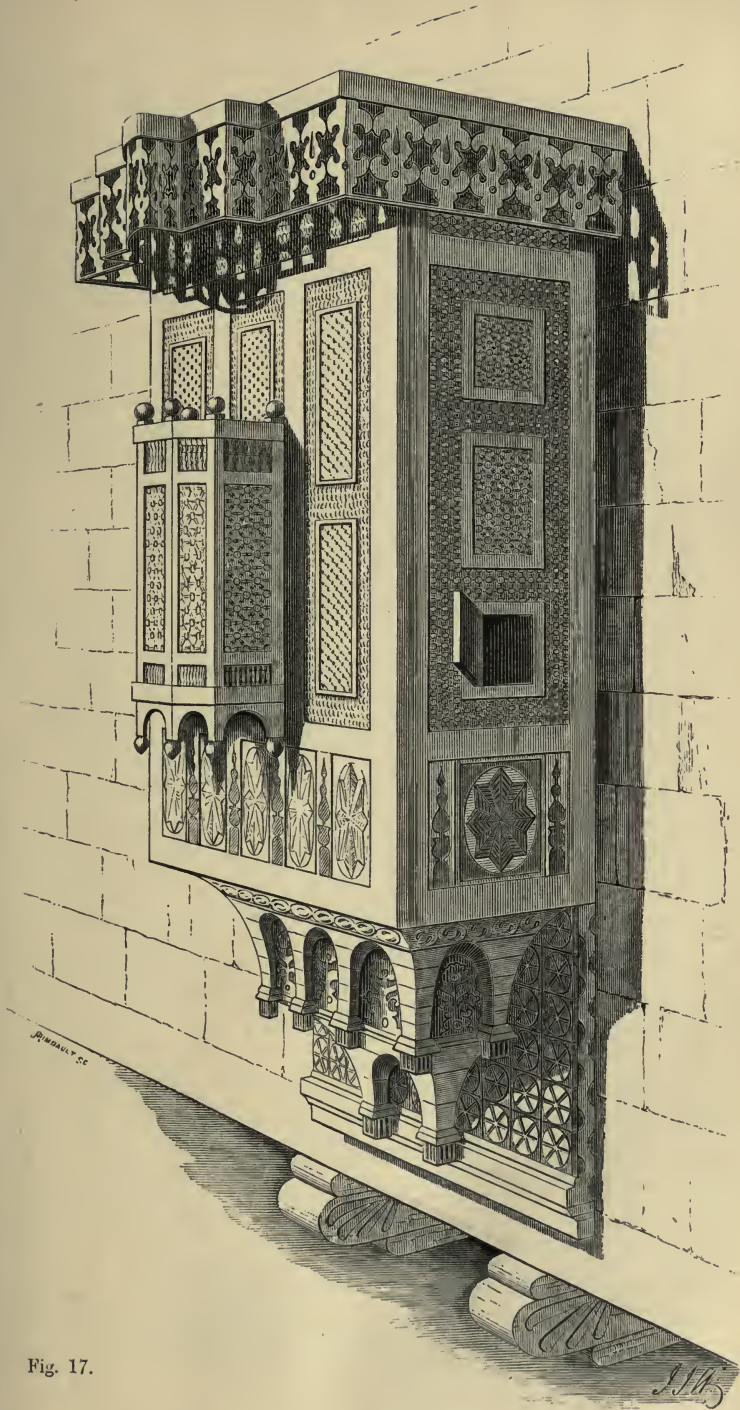

Fig. 17.

grouped to show the form of a basin and ewer, a fountain, a lion, a tree and other emblems; while the word "Allah" and phrases from the Koran are often met with. The best and most elaborate specimens are to be found in the enclosed courts of the more ancient houses.

Fig. 17, is sketched from a meshrebeeyeh projecting into the street from an ordinary Cairene house. The top horizontal panels are usually of the most open pattern fig. 10, the long vertical panels are of figs. 11, 12 or 13. The small framed panels, some of which open as doors and the smaller window or "roshan," a receptacle for water bottles, projecting from the front, are always of the more intricate patterns figs. 15 or 16. The lower portion of the window contains the divan or raised seat; this is never pierced but is covered externally with elaborate carved and fret cut ornament. The lines of the larger turned work fig. 14 are from about six to nine inches apart from center to center; this variety is employed for partitions in rooms and enclosed courts and for gratings to apertures for the passage of air, often placed above the meshrebeeyeh or high up in the walls.

Exactly the same lathe is used by the Moorish nations upon the north coast of Africa and was doubtless early carried by them into Spain, where it may still be found in common use in the southern cities. The apparatus, and the manner in which it is used leave little question as to its identity, while it appears probable that it was carried thence to South America, thus accounting for the great similarity of the lathe found there. The Indians and Creoles on the Spanish American coast, between Maracaybo and the Isthmus of Panama, use a similar lathe, and it is said, are famed for their skilfulness in turning.

The lathe commonly used by the Chinese fig. 18, is constructed entirely of wood, but the reciprocating motion is given by the feet, leaving both hands at liberty. The workman represents a maker of pipe stems, turning a bamboo fixed in the central hole of a spindle or mandrel supported in wooden collars, mounted on the top of the bench at which he is seated. Longer and larger works project to a greater extent beyond the collars, and the workman then places himself at the side instead of at the end, to turn the more central portions. The

cord is shifted from place to place as the work progresses, and it is frequently double, the ends being distended by pieces of bamboo in the form of stirrups. Occasionally the work is set in motion by a wheel turned by an assistant. The Chinese

Fig. 18.



lapidary employs a similar lathe for moving his laps, each of which is fitted to the end of an iron spindle to run in similar wooden collars.

SECTION II.—EUROPEAN LATHES WITH RECIPROCAL MOTION,
FROM POLES, SPRINGS, AND BOWS.

In the West, the improvements in the lathe appear to have resulted from the adoption of a different method of rotating the work; probably arising from the European habit of selecting the erect posture for the generality of mechanical operations. The centers were raised in height, while the bow would appear to have been discarded, one end of the string was attached to a pole or spring above the lathe, while the other was formed into a stirrup or attached to a treadle to be moved by the foot below the work. This exchange largely increased the power of rotation and left both hands at liberty for the management of the tool.

The wooden pole or spring was made from a straight bough or was cut out of some elastic wood, and pared down to a taper form; from which strip of wood or lath, the word lathe is considered to have arisen. The Greek, Latin and continental names for the machine, are all derived from the verb to turn, and with us one variety is called a "turn" or "turn-bench;" but the most common appellation among ourselves is that of lathe, and the word appears peculiar to the English language.

The earliest representation of the pole lathe with which the author is acquainted, fig. 19, is copied from a wood-cut in the "Panoplia Omnium," a work by Hartman Schopper, published at Frankfort-on-the-Main, 1568. This rare old book contains

Fig. 19.

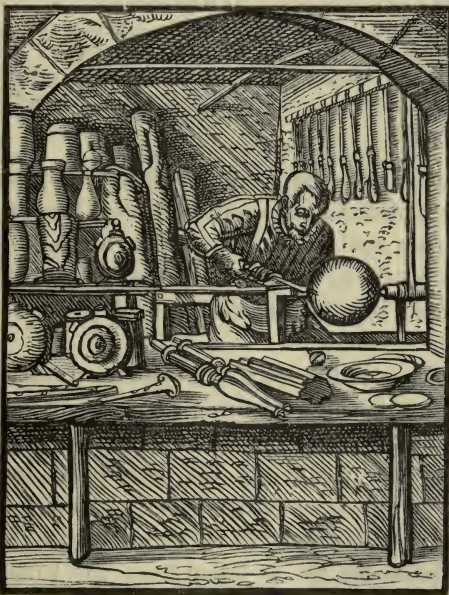

154 engravings of different trades each accompanied by descriptive Latin verses; the tool grinder from the same collection has been also given in fac-simile page 1129, Vol. III. The following, of which a liberal translation is ventured, accompany the illustration of the turner:—

TORNARIUS.—DER HOLZDREHER.

Sedulus è flava tornarius omnia buxo,
 Torno meo torno, quicquid habere voles.
 Pyxidas innumeros hominum formamus in usus,
 Immensa quæ non utilitate carent.
 In quibus abscondens rerum tibi mille colores,
 Clam penitus serues, nobile quicquid amas.
 Hic pila conficitur, mirag volubilis arte,
 Huc illuc baculis fortibus icta salit.
 Hic nec abest pueris, qui concitat acrius iram,
 Verbere quem verses per sola plana, trochus.

THE WOOD TURNER.

A turner I :—with unremitting skill,
 I turn from yellow box, whate'er you will :
 Boxes of shapes unnumbered we produce
 And who can tell our boxes' varied use ;
 There may'st thou store, secure from stranger's view,
 Thy noble treasures of the brightest hue.
 There too the ball is made, which—wondrous sight !
 Struck by the wand, rebounds in varied flight.
 Here too the top, that warms the schoolboy's force,
 And whirls on level ground its well urged course.

The mechanism of this lathe is tolerably apparent ; the end of the pole is inserted in the wall and rests loosely upon a joist stretching across the shop, that it may be shifted to different parts of the work as occasion may require. The operator stands, but rests his body against a back rail or rest attached to the lathe.

Jacques Besson, in his work, "Theatrum Instrumentarum et Machinarum," 1569, figured three very curious lathes in which the pole, the archery bow, cords and weights, are all more or less employed in producing the reciprocal motion in the machines. One of these lathes which is described and drawn page 616, Vol. II., is intended for screw cutting.

The pole lathe fig. 20, is taken from the rough illustration but careful description, found in the work of our countryman Joseph Moxon, "Mechanick Exercises or the Doctrine of Handyworks." London. 1703. and is offered for its clear explanation of details, which may prove of interest. One screw and one fixed center are carried by massive wooden blocks or popit heads, the lower ends of which are reduced to pass between the sides of the beds, for their attachment by

means of large wooden wedges through mortised holes. The wooden beds are formed of two strong beams, which, with the framing generally, are halved and bolted together. The support of the tool is a stiff bar of wood carried against the side of the popit heads, but capable of being placed at varying distances from the axis.

The pole or spring is fixed horizontally overhead, and rests on a beam by about the center of its length; the butt end being pierced by a hole to work on a vertical pin, as on a hinge,

Fig. 20.

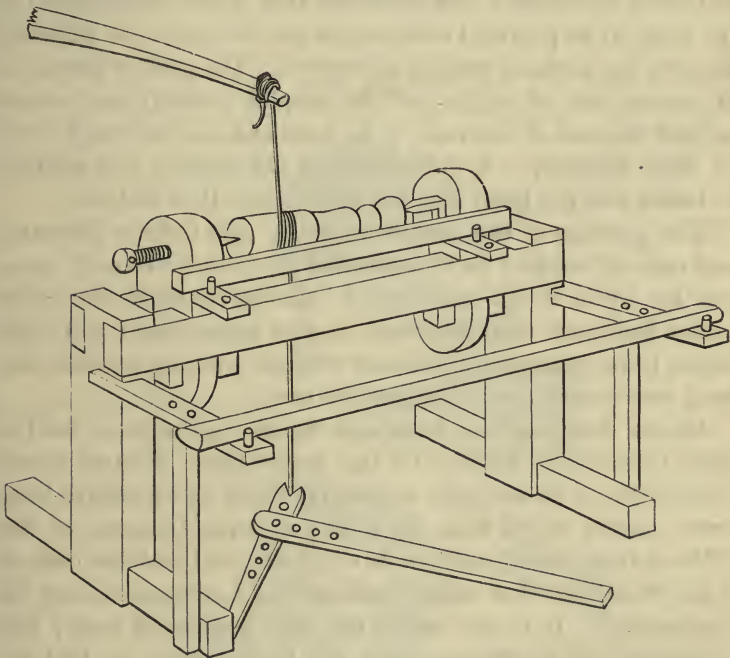

that the other extremity may be placed at any required position above the work. The cord from the pole was wrapped once or twice around the work and then descended to the raised end of the treadle, a wooden rod, the other end of which was hinged to the floor by a piece of leather. The treadle has a similar piece attached to it for the foot called the "cross treadle;" these two pieces being joined by a pin and having several holes for their adjustment to each other. When the workroom was of insufficient height to allow the pole to be used in its ordinary

position, the latter was fixed vertically at a little distance from the lathe, and the cord was led from it around a pulley attached to the ceiling and then around the work to the treadle.

Moxon recommends strength in the parts of the lathe, pointing out that a strong lathe may be used for light works, but that a slight lathe cannot be employed for heavy works, while he enlarges upon the inconveniences arising from want of stability. He describes the turner as preferring to support his work, for similar reasons, at no greater elevation above the bed than necessary; and mentions that it was customary for the lathe to be provided with several pairs of popits of different heights, for works of various diameters. The cord or string as at present, was of catgut, and the surplus quantity was wound around the end of the pole, to be unwound for use upon work of large diameter. A description of the archery bow applied to lathes and the hand bow for small works then follows.

The position of the turner using the pole lathe is fatiguing and not very secure; he is compelled to stand continually upon one leg, while at the same time he alternately raises the other rather high, and then depresses it with some force; and both hands being exclusively occupied with the tool, he requires the back rest to steady and support his body.

Moxon describes the back rest fig. 20, in the most intelligible manner, he says—"Of the seat—These *Bearers* reach " in length so far inwards, as that they may be capable to bear " the *Seat* so far off from the *Lathe*, as is the Diameter of the " Work they intend to *Turn* in the *Lathe*, and also the bulk of " the Workman that stands between the *Lathe* and it, may be " contained. It is not called the *Seat* because it is so; but " because the Workman places his Back against it, that he " may stand steddier to his Work, and consequently guide his " Tool the firmer and exacter" (page 182).

The back rest, thus quaintly described and necessary to the pole lathe, is also still very generally used by the soft wood turners, but to no great extent by any others in England. On the continent it greatly obtains among all classes of turners; an additional back rest, a curved piece of wood like the top portion of a chair back, being there also often hinged beneath the lathe bearers in such a manner that it may be brought out

at right angles to them, for support when the workman faces his work in surface turning.

The lathe fig. 21 is taken from an engraving appearing in Plumier's work (1701—1749) already referred to; it exhibits the first combination of the spring or archery bow and the wheel in the same machine. These however were employed independently. The bow had a sheave about the center of its string, from which the vertical cord was led around the work to the treadle in the usual manner; the consideration of the wheel will be deferred to the chapter on continuous motion.

The massive wood frame, is in great measure the same as

Fig. 21.

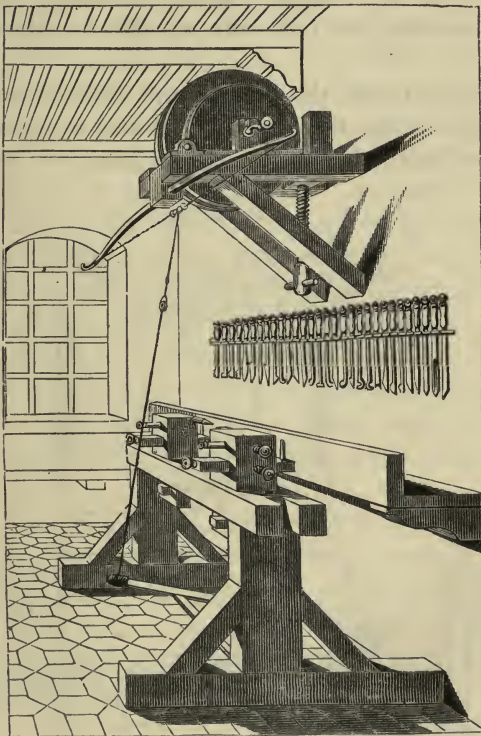

that just referred to, but with some improvement in proportion. The square bars at the top, in like manner, are placed a small distance apart to receive the popit heads; which are fixed beneath by transverse wedges at any distance from each other,

according to the length of the work. Both popit heads are provided with center screws, for the twofold purpose of axes for the work and for a finer adjustment for distance.

The reduction from a plate which appears in both editions of the "Manuel du Tourneur," by Bergeron (1792 and 1816) fig. 22, gives a different application of the bow and is without the wheel. The bow is now more rigid, and made of steel, while in place of the one string and sheave as in fig. 21, there are three or four which pass through a sheave or pulley in the center of their length. The cord is wound around the sheave and around the work, the depression of the treadle rotating both; the bow strings being twisted, contract and to a slight extent shorten the stubborn spring, bringing into play the elasticity required to raise the treadle for the succeeding stroke.

The alteration from the pole to the archery bow, was little improvement except that it rendered the reciprocating lathe compact and portable; on the other hand, the advantage of

Fig. 22.

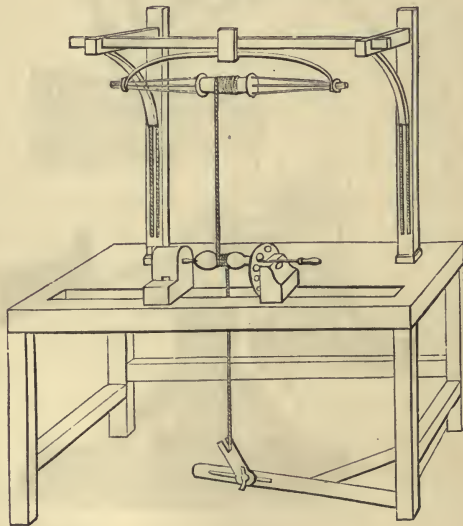

shifting the cord to any part of the work was in great measure lost, and this inconvenience directly led to the adoption of the different methods of producing continuous revolution, described in the succeeding chapter.

Of the lathes with reciprocating motion, those of the simpler construction, fig. 20, and the watch turn or turn bench, alone continue in use; the former, among other purposes, being used for the manufacture of the rods or rounds and legs for chairs, either plain cylindrical pieces tapering towards their ends, or carrying some simple ornament of beads or collars at the center of their length. This industry is sometimes carried on close to the growing wood, the two popit heads with center screws and the turning tools being nearly the only permanent portions of the apparatus; the remainder being constructed of the materials on the spot. The wood for the work having been cut into suitable lengths, is *split* into pieces to ensure straightness of grain, and these are then chopped and afterwards reduced nearly to size with the paring knife. The pole and the cord are arranged so as to considerably raise the treadle, that the downward stroke of the foot may give the work several revolutions; sufficient to permit the one side of any bead or ornament, to be formed by a single cut of the chisel during one stroke of the foot. Although the body is supported by the back stay, the work is fatiguing on account of the great elevation of the leg necessary for every stroke. The workman therefore obtains relief, by constantly varying his occupation, splitting, chopping and paring one or two dozen rounds, and turning them alternately.

Another instance of the continued use of the pole lathe, is exhibited by the common wooden bowls used for domestic purposes; many of these, are perhaps the largest soft wood

Fig. 23.

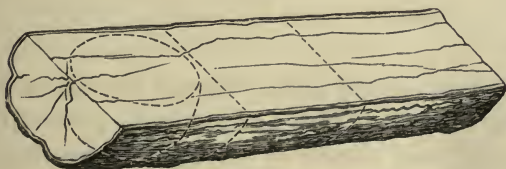

Fig. 24.



hemispheres produced in the lathe, while their manufacture presents some points of interest. The bowls range from four to about eighteen inches in diameter and are externally and internally a fair approximation to the hemisphere; the outside base, slightly flattened that they may stand. They are usually

made from elm, always the plank way of the grain, and are cut one from within the other to save material and labour. The portion of the tree selected is round, straight and without branches, and, as with the portions of the chairs referred to, is manufactured shortly after being felled while still soft and full of sap. The wood is first sawn down the center, which gives it a transverse section approaching the shape of the bowl, it is then cut across into suitable lengths, which are roughly rounded with the axe to a similar section, in the direction of their length. The rough piece fig. 24, is next mounted between the center points of the pole lathe, and the outside turned to shape, leaving a cylindrical portion for the cord. The hand rest is then placed parallel with the surface, and a series of grooves from one to two inches deep, are turned in the face of the work with a strong hook tool, held horizontally; the grooves sufficiently distant from each other to leave the edges of the bowls of appropriate thickness, figs. 25 and 26.

The straight stemmed hook tool is made both to deepen and widen the grooves, that it may be perfectly free within them.

Fig. 25.

Fig. 26.

Fig. 27.

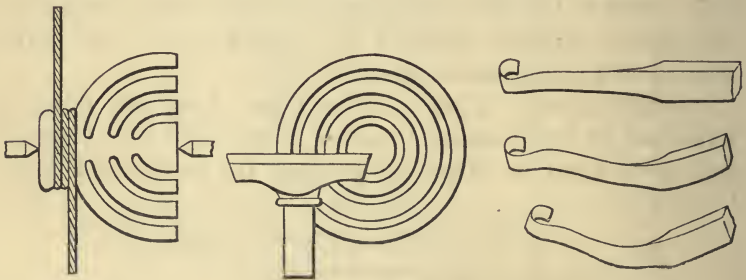

It is then exchanged for others, slightly curved in their stems, with which, cutting upon their ends and sides, the grooves are carried a little further and deeper, at curves corresponding to the curvatures of the different bowls; these tools in like manner are then exchanged for others with shanks still more curved, until by such continued succession, the curved grooves are carried down to the required depths and shapes.

During these operations, the tools are embraced on all sides within the grooves, their curved stems and the increasing

depth, completely concealing their cutting portions. With continuous motion in the work, as in the ordinary lathe, they would soon become fixed or clogged by the accumulation of the chips, full of sap, collecting between the sides of the grooves and the tools, which would render them unmanageable. It is in this respect that the intermittent motion of the pole lathe is valuable, the tool cuts only at the down stroke, while the up stroke, which is against the tool, each time clears it from the chips, which come tumbling out of the groove above it. The grooves completed, the block fig. 25, is removed from the lathe and the different bowls are detached, by being forcibly split out from each other, the fractures being made at the base of each and in the direction of the grain. The under surfaces are turned flat, and some precautions are taken, that the bowls so far prepared green, shall not dry out of shape; occasionally they undergo subsequent finishing.

The smallest of all turning apparatus is to be found in the hands of the watch and clock makers, with whom the bow lathe has never been altogether superseded, and it is extremely well suited to their purposes. Many of these miniature lathes are used only for specific work, from which they derive their names, such as Balance turn, Pivot turn, Screw head tool, and others; fig. 28, the turn, or turn bench, is the most generally useful. All are made entirely in metal and are used held in a table vice; the bow is a light elastic cane or piece of whalebone with a fine catgut, or for delicate work, a single horsehair, the bow, then being also correspondingly slender. The graver, almost the only tool used, is held obliquely to the axis of the work, its chamfer upwards, the work is turned with the extreme point of the tool and is smoothed with one of its side edges; this being almost the only means used by the watchmaker to turn the most delicate hardened steel pivots, some of which, when turned, polished and burnished measure less than the three-hundredth part of an inch in diameter.

The turn bench fig. 28, which measures about nine inches in length, is suitable both to the watch and clockmaker for the larger and smaller parts of their respective works. The turn

used for the delicate axes, above referred to, is less than a third this length and proportionately slighter; the bar and the heads are formed of one solid piece, the only movable parts being the cylindrical brass axes neither of which is screwed, and the rest for the tool.

All modes of turning with alternating motion, are alike subject to the same disadvantage, viz., that the tool can only cut whilst the work is moving towards it; the tool is not only inoperative during one half the time spent upon the work, but it is also necessary to withdraw it just out of contact during the opposite retrograde motion, to avoid the destruction of the cutting edge from friction. The tool receiving a restless backward and forward motion simultaneous with every change of direction. Though necessary for some purposes, among others for works in which some projecting stud or other part stands in the path of the tool, and still exclusively employed in many parts of the world; the reciprocating and the pole lathes are rapidly falling into disuse in Europe; nevertheless inde-

Fig. 28.

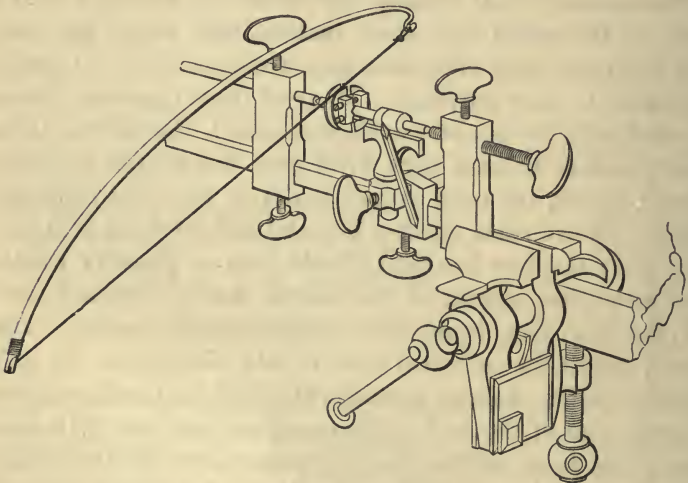

pendently of their simplicity which has a certain merit, the pole lathe has some peculiar advantages.

The cord being wrapped around each piece of work as it is turned, the speed required for every diameter is adjusted without any attention on the part of the workman; the surface

velocity being always equal to the rapidity of the foot. Less speed being required for turning metal, this may be arrived at by attaching a pulley on the work fig. 28, which at the same time affords the cord greater purchase or leverage; and if the pulley be chosen four, six, or any number of times the diameter of the work, the relations of velocity and power may be variously adjusted. There is also an advantage in the two ends of the cord being carried away in opposite directions; their action being opposite and equal, they counteract each other and there is little bending pressure exerted on the work. The friction of the pole lathe is also scarcely more than that inseparable from every cutting process; the resistance offered by the shaving, to its removal from the material.

A method of imparting a continuous direction to the rotation of the work, by the single cord of the pole lathe, fig. 29, taken from a model in the Museum of the late East India Company, may be considered as of interest and to some extent as a link between the reciprocating and the rotatory motion. The cord from the pole is first passed under the work, around a pulley overhead, and then hitched around the work before proceeding

Fig. 29.

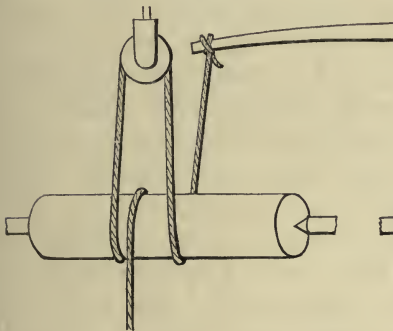
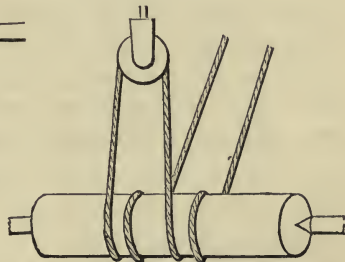

Fig. 30.



to the treadle below. On depressing the treadle, the half of the cord hitched around the work acts precisely as in the ordinary pole lathe, but also, overcoming the friction of the other half of the cord, half of which is then travelling in the opposite direction, bends the pole; the pressure being relieved from the treadle, the entire half of the cord attached to the

pole, continues the revolution of the work in the same direction, while the opposite half of the cord then slips around the cylinder. Both halves of the cord hitched around the work and pulled alternately by the hands, fig. 30, will in like manner cause a continuous direction in the revolution.

Little advantage is derivable from this arrangement; the motion although always the same in direction is intermittent, the work suffering a momentary check at its dead points at the termination of every ascent and descent of the treadle; while the power communicated at the ascent and descent is unequal. The re-duplication of the cord, both halves of which should also work upon similar diameters, is inconvenient, and the arrangement, which is more curious than practical, does not appear to have come into use.

CHAPTER II.

CENTER LATHES WITH CONTINUOUS MOTION.

SECTION I.—INTRODUCTION OF THE WHEEL. HAND WHEELS.

THE adoption of the wheel and constant revolution in the lathe, eventually superseded the various methods of obtaining reciprocal motion from poles and springs. But, it is rather curious that the advantages attending this improvement, long previously enjoyed by the potter with his horizontal wheel, should have been so tardily appreciated by the turner; who appears for a long time, still to have adhered to the old and accustomed reciprocating action.

The details of the potter's lathe or "throw," the earliest lathe with continuous revolution were, and still remain, of the most simple character. The workman is always seated in front of a framework which supports a vertical spindle, upon which towards the base, there is a horizontal driving wheel. The spindle was kept in revolution by the action of both feet upon the flat surface of its driving wheel, and the machine is still so used; but is now more generally driven by an assistant with a hand fly wheel, or by power. The work revolves upon a horizontal circular table upon the upper end of the spindle. The term throw, also applied to the clock throw fig. 37, appears to have originated from this art, either from the mass of clay being thrown upon the horizontal surface of the revolving table, which is its sole means of attachment, or from the dimensions of the nascent vessel being extended or thrown outwards by centrifugal force; so great being the latter, that if the speed of the wheel be considerable when the clay is unsupported on the outside by the hand, the plastic material at once spreads out into a flat disc shaped form.

The employment of the feet to give revolution to the potter's wheel, was however not quite invariable. Plate 50 of Rossellini's work, previously referred to, represents two ancient

Egyptians seated on the ground face to face; the one turning a small wheel without intermission with the left hand, while he fashions the clay placed upon its surface, with his right; the other workman, shaping the outer surface of a vase in a similar manner at another wheel. Other exceptions may doubtless be found, among them are some of the natives of Upper India, who place the clay upon a flat heavy stone supported upon a central pivot; they give the stone a whirl with the hands, quickly fashioning the clay so long as the motion continues, alternately setting the stone in revolution and shaping the work.

In the great majority of machines a vertical position is necessary for the driving wheel; which, in its simplest form is a part of the work itself, turned by a revolving lever or winch handle attached to its axis, as in the grindstone or common draw-well. But when the work requires greater or more uniform velocity, as in the lathe, the driving wheel is detached from the work and mounted upon some part of the machine in connection with the different communicators of the power employed. The earliest representation of the wheel used for driving the lathe, is met with in Schopper's work (1568). He exhibits the detached fly wheel as used by the turner of pewter tankards, who is working at a center lathe set in motion by a fly wheel, turned by a second person. De Caus, "Les raisons des Forces Mouvantes," folio, Paris (1624), plate 8; gives an excellent drawing of a curious lathe for oval turning, also set in motion by a wooden wheel on a detached stand; and Moxon (1677), page 179, thus describes the advantages of the fly wheel.

"Of the Great Wheel."

"Besides the commanding heavy Work about, the Wheel
 "rids Work faster off than the Pole can do; because the
 "springing up of the Pole makes an intermission in the
 "running about of the Work, but with the *Wheel* the Work
 "runs always the same way; so that the Tool need never be
 "off it, unless it be to examine the Work as it is doing."

Felibien (1690), Plumier (1701), and other authors, describe various forms of both hand and foot fly wheels, but nevertheless

exhibit a decided preference for the reciprocating motion obtained from the pole or spring bow.

The hand driving wheel fig. 31, is reduced from an engraving in the "Manuel du Tourneur" (1816). The wheel had three speeds and together with its pedestal was con-

Fig. 31.

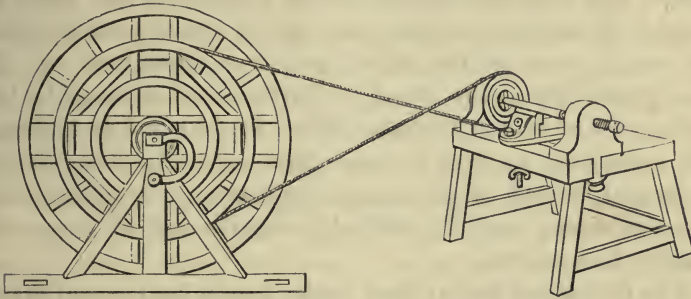

structed entirely of wood; the axis and winch handle were of iron. The cord ran directly on the surface of the work, or, when that was of small diameter, to a pulley fixed upon it. One or two men being employed in turning the wheel according to the magnitude of the work.

SECTION II.—FOOT WHEELS.

The fly wheel driven by the foot, attached to the lathe as part of the machine, now offers abundance of power for all ordinary turning, and renders the workman generally independent of assistance. Although so slowly adopted by the turners, it was early employed in other handicrafts. In addition to the grindstone with crank and treadle turned by the foot of the workman, reproduced in the third volume of this work; the Gem engraver is also found in the trades collection of Schopper, and the same artist is drawn by Felibien. In both illustrations, they employ foot wheels the axes of which extend across the frames of their lathes; the treadles are jointed under the heel of the artist, and are set in motion by a small movement of the ankle joint, insufficient to disturb the quiescent position of the body, any movement in which would introduce a most serious difficulty in so minute and delicate an art. The same apparatus, of which the modern form will

be found pages 1349—1363, Vol. III., continues to be used without material alteration, except in the occasional introduction of an intermediate axis with a second pair of pulleys to increase the velocity.

The exclusive or even general use of the foot wheel for the lathe, was probably considerably retarded, first, by the very simple and economic nature of the pole lathe, and then, by imperfections in the construction and in the manner in which the employment of the wheel was first attempted. In its earlier application, the wheel was always accompanied by the spring bow or pole in the same lathe, fig. 21; and in working, the preference appears to have been generally given to the reciprocal instead of the continuous motion; doubtless from the inefficiency and the difficulty experienced in using the original foot wheels.

The foot wheel was at first made from a flat piece of wood, a cord passing from its cranked winch handle to the treadle; and the spring having been always placed above the lathe, the

Fig. 32.

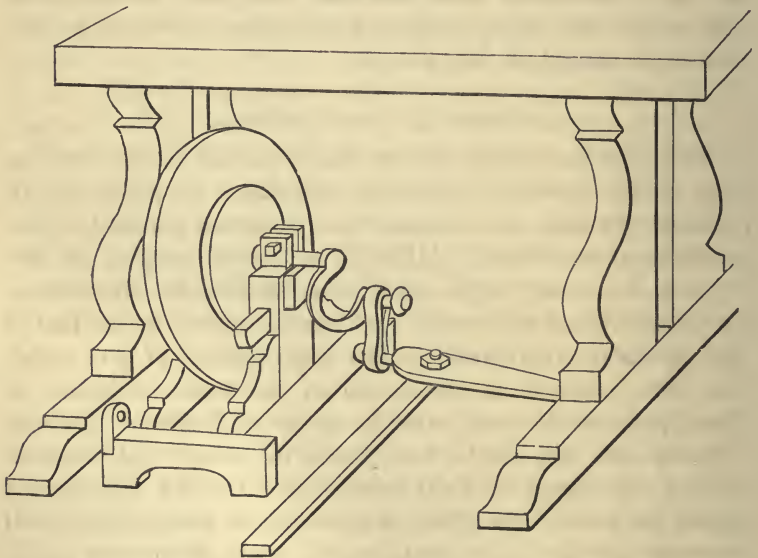

same position was selected for the wheel. An exception is found in Moxon, who places the fly wheel beneath the lathe, arranged somewhat after the modern manner; but Plumier

recommends that the wheel should be placed, above, below, or at the side of the lathe, as may be found most convenient to the work and the dimensions of the workroom. The wheel in fig. 21, is fixed above, being mounted in an adjustable frame supported upon joists inserted in the wall; the frame was raised or lowered by a wooden screw, to place the driving band on or off the work or to accommodate its length. The inaccessible position of the wheel to the workman, to start or check its revolutions, constantly necessary in examining the progress of the work, and the elasticity of the long cord, were among other objections to this arrangement. The foot wheel fig. 32, is copied from that given by Plumier, to be used beneath the bearers; it was mounted upon distinct standards, that it might be removed whenever the work was set in motion by the spring bow. This wheel is described as of two pieces of wood of different diameters attached to each other, the larger, to obtain momentum, having a plain edge, the smaller with a groove for the band. The axis of the wheel was raised and lowered to adjust the length of the driving band, by wooden wedges passing through mortises in the two uprights; and, when the wheel was used, the one foot of the frame was temporarily fixed to one foot of the lathe by pieces of wood, and metal pins. The back of the treadle was attached to the pin of the winch handle by a short leather loop, its opposite end having a metal eye to be placed on a hook fixed to the inner side of the lathe standard; the other half of the treadle was for the foot, and the two were loosely jointed together by a pin and nut.

The same author describes another and yet more temporary mode of attachment for the foot wheel, fig. 33, that of hanging it directly to the bearers. The axis of the wheel was fixed to a broad upright piece of wood, which was carried upon the face of a longer similar piece, fixed to the bearers by a transverse wedge, somewhat after the same manner as the popit heads. The adjustment for the length of the driving band was obtained by a tenon fixing in a long mortise by means of a wooden wedge.

The elasticity of the treadle cord, the small diameter and the slight weight of these driving wheels, and the friction of their bearings, all tended to impede their continuous revolution;

improvement was sought by weighting the wheel with metal plates, while to obtain a smoother action the workman is directed, when possible, to make the length of the foot treadle some ten or twelve times that of the "elbow" or crank. The best results as to power that could be obtained however, must still have contrasted very unfavourably with the

Fig. 33.

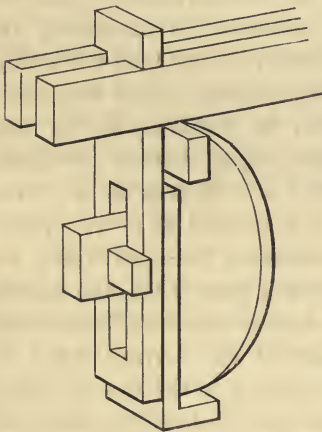
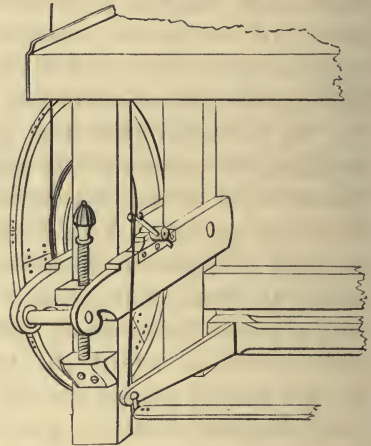

Fig. 34.



strong and simple action of the pole and bow. Subsequently the fly wheel, unaltered in form and material but increased in size, was attached to the upright of the lathe in the manner described and shown by Bergeron, fig. 34. A straight rod with a stud here replaces the curved crank, but the leathern thong, the flat edge to the wheel, and the screw adjustment were still retained.

Nevertheless, at the same period, the more elaborate portable lathes described by this author, 1816, were still provided with both the bow and the wheel, separately mounted. The wheel, of rather small size, together with an elaborate apparatus of screw adjustments to regulate the tension of the band, was placed above the level of the workman's head, upon the top of a slight pedestal erected on the backboard of the lathe. The pedestal being frequently elaborately ornamented as a column of one of the architectural orders. The wheel was thus within reach of the hand, but want of stability was now added to its other defects.

Foot wheels made entirely of wood, although still occasionally met with, are insufficient to overcome the resistance in turning ordinary large work, even when they are weighted near the circumference to increase their momentum. The arms and center, or these and the rim of the wheel, were next cast as one piece in iron, and a wooden tire was attached, in which the grooves for the band were turned when the wheel was mounted in its place. The axis was also extended to a fixed intermediate standard, bent as a crank, and made to revolve upon fixed centers instead of running in bearings, greatly reducing the friction; while the elastic thong was exchanged for a rigid metal rod, formed into a hook to embrace the crank pin, with its lower end attached to the treadle. Ultimately, the axis was extended throughout the length of the frame, the entire wheel was cast in iron and the flat edge and screw adjustment were abandoned; the tension of the band being effected by the simple expedient of forming the edge of the wheel into three or four grooves of slightly decreasing diameter side by side, the band being tightened or slackened by shifting it from one groove to the next.

Moxon, page 179, gives such distinct directions as to the mode of using the foot wheel of his time, that it would be difficult to find clearer or more vigorous language in which to place it before the reader; he says:

“ Of the Treddle Wheel.”

“ This is a *Wheel* made of a round Board about two Foot
 “ and an half Diameter, conveniently to stand under the
 “ *Cheeks* of the *Lathe*. It also has a *Groove* on its Edge for
 “ the *String* to run in; it hath an Iron *Axis* with a *Crook* or
 “ *Crank* at one end: And on the *Crook* is slipped the Noose of
 “ a *Leather Thong*, which having its other end fastened to a
 “ *Treddle*, does, by keeping exact time in *Treads*, carry it
 “ swiftly about without intermission.

“ But the length of the *Thong* must be so fitted, that when
 “ the *Wheel* stands still, and the *Crook* at the end of the *Axis*
 “ hangs downwards, the end of the *Treddle* to which the *Thong*
 “ is fastened may hang about two or three inches off the
 “ ground: For then, giving the *Wheel* a small turn with the
 “ Hand, till the *Crook* rises to the highest, and passes a little

“beyond it; if just then (I say) the *Workman* gives a quick
 “*Tread* upon the *Treddle* to bring the *Crook* down again with
 “a jerk, that *Tread* will set it in motion for several revolu-
 “tions; and then, if he observes to make his next *Tread*, just
 “when the *Crook* comes about again to the same position, it
 “will continue the motion, and cause of the motion, and keep
 “the *Wheel* always running the same way, if he punctually
 “makes his *Treads*.”

SECTION III.—THE DRIVING WHEEL CONSIDERED AS TO MO-
 MENTUM AND AS A SPEED PULLEY. VARIETIES OF HAND
 FLY WHEELS.

Fly wheels afford the lathe two important advantages. Their momentum, equalizes the results of the varying muscular effort expended in driving them; storing up all in excess for the work or load to be overcome, and parting again with just so much, as is necessary to carry on an equal revolution under occasionally increased strain, and during the recurring periods of diminished effort. Thus, permitting a maximum of power to be conveyed to the work, with a minimum of fatigue to the operator. In the second place they serve as speed pulleys, and communicate the power with its rate varied to different velocities, suitable to work of different densities or magnitudes.

The momentum of the hand fly wheel allows the operator to exert the principal portion of his force at the two most favourable parts of its circuit; in pulling up, at a small angle with the perpendicular, during the ascent of the handle, and in thrusting down in the same manner on its descent; while it affords him a momentary slight relief at the intermediate points, at which, from the more nearly horizontal position of the handle he can exert little power. The weight and velocity being suitable, the momentum regulates or governs these four unequal efforts, melting them into one uniform force spread over the entire revolution. When therefore two handles are applied to one fly wheel, they are usually placed at right angles to each other, which combines a maximum and minimum effect at one time, and equalizes the power. The handles of large fly wheels usually vary from about ten to eighteen inches in radius. A short radius which reduces resistance and gives a quick pace to the wheel, is usually preferred to the slower and

heavier pull necessary to the longer, when the assistance derived from momentum is also less. The extremes of velocity attained with the hand fly wheel, may be considered as from about fifty to twenty-five revolutions per minute, respectively, the former gaining the most advantage from momentum; the pace of the revolutions therefore should not be unduly diminished, as it is far less laborious to the operator to continue using the half of his force, with a velocity of say thirty revolutions, than the whole, with that of fifteen.

With the smaller light hand wheels, the question of momentum becomes nearly unimportant; the limited path of the handle is entirely within the range of action of the hand and arm, and the slight force called for, can be readily applied to all parts of the circuit without the aid of momentum; while from the same reason, the axis of the wheel may generally be placed indifferently, vertically for the turner, horizontally for the lapidary, or in any intermediate position otherwise required.

The action of turning a foot wheel by its treadle, already described by Moxon, somewhat resembles that of ascending stairs; the analogy lying in the manner in which the force is applied to the treadle board. On the stair, the weight of the body is gradually thrown on the one foot, and as gently relieved when it is taken up by the other foot on the next stair. The muscular effort of the foot on the lathe treadle is equally gradual. The knee is bent, and the downward push of the foot which commences quietly, is greatest at the middle of the stroke, then diminishes and entirely ceases at the end, in order to offer no opposition to the rising of the treadle by the revolution of the crank. The jerk to be given at the first moment of the tread, as described by Moxon, was required to overcome the elasticity of the crank thong; with the rigid hook it is no longer necessary nor desirable.

It has been said that the hand wheel receives two impulses to every revolution, the foot wheel can receive but one; and therefore to obtain sufficient momentum to carry this lighter wheel through the two-thirds of its circuit, during which the foot is inert, it is requisite that it should move at least twice as fast as the hand wheel. The motion of the ordinary foot wheel

can barely be maintained when it falls below thirty revolutions to the minute, two, three or four times that velocity are usual, while, for many purposes of turning and polishing, the velocity is often very much higher.

The weight of the fly wheel, upon which combined with its velocity, the momentum depends, is determined by circumstances. In the spinning wheel, with which the velocity is very great while the resistance is inconsiderable; the wheel can scarcely be too light, that it may be instantly checked to stop the machine, constantly necessary to repair the thread. With large fly wheels, applied to continuous work in pumping, or in driving heavy machinery such as that for rolling iron, where the stoppages are rare, but, in which the resistance is frequently and considerably varied; the weight becomes very great, the principal limit arising from the friction of the axle, which increases directly with the weight of the wheel.

For the foot lathe, an intermediate course has to be followed; the fly wheel should be sufficiently heavy, for its momentum to ensure uniformity of motion, to overcome an occasional increase in the resistance from a hard place in the material, or from an extra depth of cut; but yet not injudiciously so, as it is continually necessary to stop the lathe to examine the progress of the work. The equal efforts employed in starting the wheel from a state of rest and carrying it to any given velocity, and afterwards destroying this motion in stopping it, are so much taken away from the employed and productive power of the operator; and needless weight in the wheel correspondingly increases this loss. The fly wheels suitable to foot lathes therefore, generally vary from about twenty to thirty inches in diameter, and are from about forty to a hundred and twenty pounds in weight.

As a speed pulley, the fly wheel converts the velocity most easily obtained by the operator, into that called for, by the size and density of the particular material under reduction in the lathe. The speed employed in turning the soft woods can scarcely be too high, but with ivory, the hard woods, the soft, and then the harder metals, a gradually decreasing rate of motion is required; ending indeed for some large works in the

last, in power lathes, with the slow rate of ten to fifteen feet per minute, measured at the tool.

To meet these conditions, it is usual in the driving apparatus of all lathes, whether driven by hand, foot or power, to have a variety of grooves or steps of different diameters in the fly wheel and in the pulley; that different steps may be employed to give different speeds, upon the simple law of the velocities being inversely as the diameters. The diameters being equal, the wheel and the pulley on the mandrel move turn for turn; the groove on the wheel being six times the diameter of that on the pulley, the latter will move with six times the rapidity of the former and so on.

The one extreme or face of the conical mandrel pulley, is generally made as large as the lathe head will admit, the smallest groove at the reverse end, being usually about half that diameter. Sometimes the smallest grooves of the pulley are proportionately much less, as in the lathes of the soft wood turner, whose work offers the least resistance and requires the highest velocity. The edge of the foot wheel is formed as a bevil nearly the same as that of the mandrel pulley, turned into grooves of about a corresponding number. For slower speeds, additional bevils of less diameter turned with grooves, are carried on the front of the spokes; the foot wheels being termed single, double or triple bevil wheels according to the number of the series.

The hand fly wheel has been very generally supplanted by power, nevertheless it still remains in use for many industries, it is convenient for occasional purposes in all workshops, while it has the recommendation over most motors, of simplicity and almost impossibility of derangement. The largest and lightest handwheels are those used by the soft wood turners; these are made of wood with spokes very like the wheel of a carriage, and measure from six to eight feet in diameter. Occasionally they are provided with speed grooves, but a plain rim with a light, flat strap, running to different steps on the mandrel pulley, is more general. The wheel is mounted on a stand, that is pulled along the floor to tighten the band, but occasionally its axis is carried by an adjustable swing upright.

The cutler's or grinder's wheel is very largely used, this is

of the same kind but rather smaller in diameter. Two long, parallel wooden bearers, about eighteen inches high, carry the centers for his buffs and grinding wheels; the bearers run along the floor of the shop and the workman sits astride or with his legs between them. The fly wheel is mounted behind him, frequently upon the same bearers, its lower half revolving

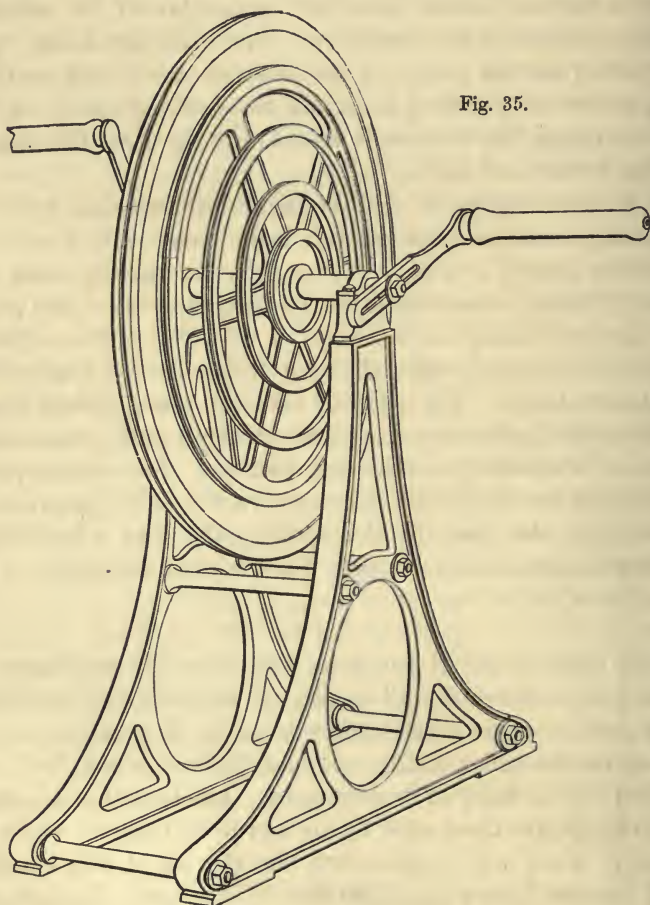

Fig. 35.

in a pit or recess in the ground. The potter, when engaged upon the largest specimens of his art, requires a slow rate of speed in the revolution of the throw; which he also obtains by means of the hand fly wheel, in this case of from about three to four feet in diameter, turned by an assistant.

The hand fly wheel for general purposes, fig. 35, and its frame, are entirely of iron, the five speed grooves being from about eight, to about forty inches in diameter ; which, combined with the speed grooves of the pulley, give suitable rates for most metal work. For wood turning of small diameter, one band would be carried from the largest groove of the hand wheel, to one of the smaller on the foot wheel of the lathe, and a second band from the largest of the foot wheel, to one of the smaller on the pulley. The weight of the wheel and stand is sufficient to maintain the tension of the band. The hand fly

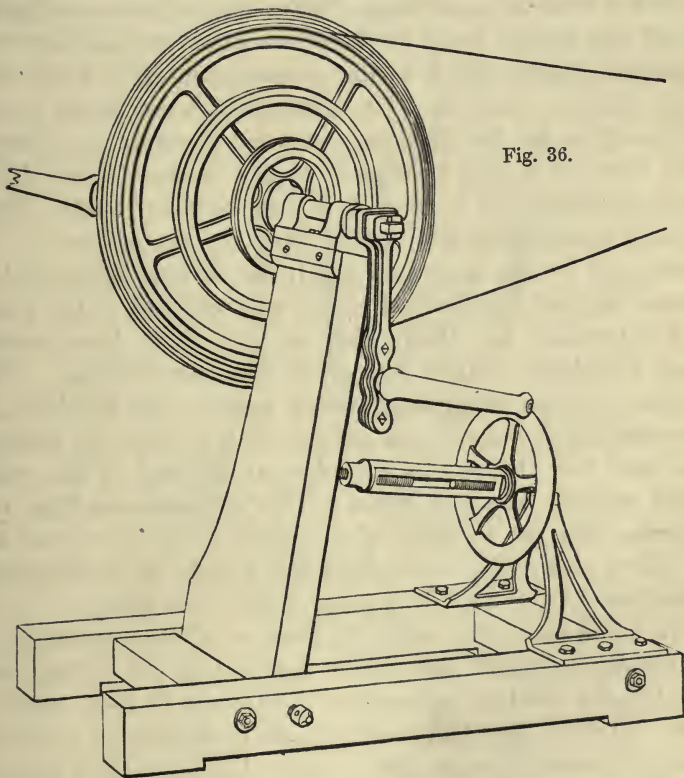

Fig. 36.

wheel, suitable to the amateur, fig. 36, has a triple bevil wheel mounted on a swing upright, the tension of the band being regulated by screw adjustment ; the speed grooves measure from about eight to about thirty inches in diameter. In both

these fly wheels the two handles stand at right angles, and can be placed at different radii.

The amateur sometimes desires to drive the lathe by other means than by the foot or the hand wheel, and seeks assistance in some variety of engine or water power; the latter is not very generally available, but the former is frequently attempted. Except for manufactories, power is a less convenience than would at first appear, and its uniform pace prevents the gradations of increasing or decreasing speed, so valuable in the practice of hand turning, and easily, almost intuitively given by the foot, after moderate practice. This advantage is so considerable, that in manufactories where steam power is applied to all the lathes, many of them are also provided with the ordinary treadle, which is almost always resorted to for the more delicate operations. In those cases where steam power is already in use for other purposes, and therefore under separate control; it may be applied to the amateur's foot lathe with advantage, for occasional use as for heavy works. But, when both using the lathe and driving the engine have to be performed by the same individual, the divided attention becomes irksome, and leads to errors and accidents to the work, and experience has shown that such attempts have usually been abandoned as less convenient than troublesome. The ordinary manner of applying steam power to the foot lathe, is by attaching fast and loose pulleys, with a lever for shifting the band from the one to the other, at the end of the crank shaft opposite the foot wheel. This arrangement does not interfere with the variation of the speeds by the grooves of the fly wheel and pulley, and allows the treadle to be employed when the driving band is running on the loose pulley.

In a well made foot lathe, the friction of the working parts is usually so slight, that when the tool is not cutting, the mechanical exertion of working the treadle is soon scarcely felt. While in light hand turning, and in driving the revolving cutting frames in ornamental turning; the foot is often entirely withdrawn from the treadle that the workman may stand upon both feet, to obtain greater steadiness for an exact or delicate cut, or for making adjustments with the division plate and index. At these times the momentum of the fly wheel will cause the lathe to continue very many revolutions before its

speed materially slackens, and the speed is again immediately increased, so soon as the foot is placed on the treadle to take up and continue the motion.

The turn bench, fig. 28, but of rather larger dimensions, is sometimes provided with a small hand wheel of from ten to eighteen inches diameter, together with the additions represented in fig. 37, when it becomes the clockmaker's *throw* or dead center lathe. The wheel is turned by the left hand and the tool as before is held in the right: the horizontal framework is grasped in the vice, but, it is also occasionally permanently screwed down to the bench. The work revolves between fixed centers, but the pulley, which is no longer fixed upon it, as in the turn bench, revolves freely on the center on

Fig. 37.

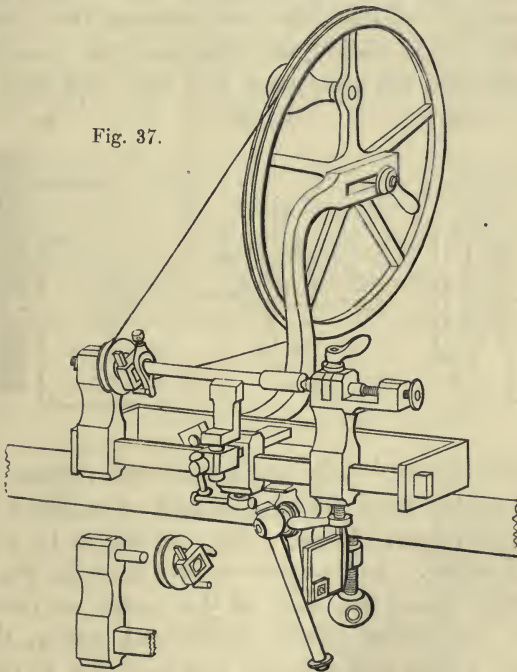

the left; shown by the detached views of the fixed center and pulley. A movable square piece, fastened by a thumb screw to the front of the pulley, filed square to receive it, carries a

projecting pin which catches against a screw clamp or carrier fixed on the work; the pulley communicates its motion to the work driving it before it, the two parts in contact being called the *driver* and the *carrier*. The driving wheel is adjustable upon the arm by which it is carried, to regulate the tension of the band, and the latter is usually crossed as a figure of eight, to obtain increased wrapping contact around the pulley; the driving wheel being also slightly inclined from the perpendicular to prevent the band chafing when so crossed, and the work may now be removed and replaced, without deranging the band. The continuous revolution renders the clock throw much more expeditious than the turn bench, and fig. 37, is a very convenient little lathe for much small turning.

The dead center lathe with loose pulley, of which the clock throw is the smallest variety, may be considered as a permanent tool, derived from the fixed centers of the reciprocating lathe; lathe heads embodying this principle constructed of considerable size, are sometimes met with, and they are well

Fig. 38.

Fig. 39.

Fig. 40.

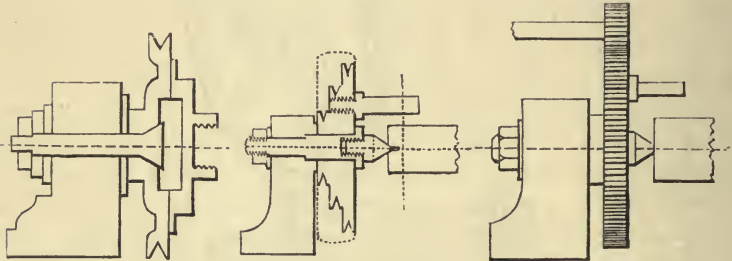

adapted both to heavy works and for accurate results. Fig. 38, is a dead center head forming a part of a lathe for oval turning, copied from Plumier; this was driven by a band on its grooved pulley. In the more modern form fig. 39, used for larger works; when the hold of the catgut or rope in the grooves of the pulley affords insufficient power, these are replaced by a strap and a broad pulley, shown by the dotted lines. In turning work of still greater size, the strap and pulley in their turn are insufficient, and a wheel and pinion are then employed for the rotation. A large toothed wheel replaces the pulley, and a pinion of about one-third or one-

fourth the diameter of the wheel, is attached to the same standard by a separate axis. The dead center lathe from its simplicity and efficiency, was long a favorite in the hands of the millwrights; with them, the pinion axis terminated in a winch handle or in a fly wheel; when now employed, it usually carries a pulley and is driven by power.

SECTION IV.—CRANKS AND TREADLES OF FOOT LATHES.

The cranks and treadles for driving the fly wheels of foot lathes, have been made of many different forms, some of which have been shown. For the earlier foot wheels, figs. 32—34, the axis was of a length only sufficient to run in bearings to support the wheel; one end being formed into a short crank nearly resembling a winch handle. Sometimes, indeed, there was no crank, but a stud was inserted in the side of the wheel or in one of its spokes, or, the end of the axis was pierced transversely to receive a short straight rod, terminating in the stud for the reception of the loop of the treadle thong.

So soon as the wheel axis was extended in length, it was bent as a crank, the bend being first placed close to the wheel, but subsequently about the center of its length. The lengthened crank axis was at first forged square as in fig. 63,

Fig. 41.

Fig. 42.

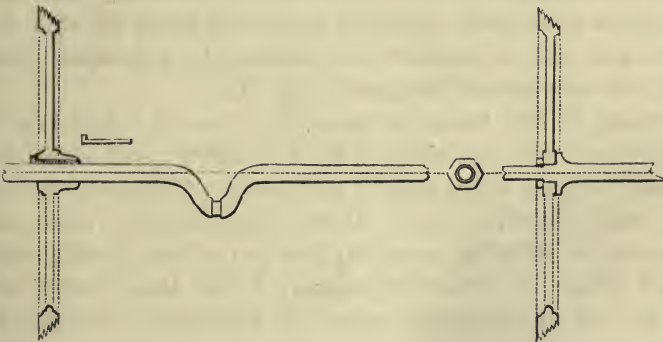

and it passed through a square hole in the fly wheel, the two being fixed to each other by means of wooden wedges; the crank or bend itself was also rectangular, a form still frequently met with.

The modern crank shaft, fig. 41, is round and the bend, which is nearly of the same thickness with the shaft throughout, is gradual and without angles. The fly wheel, as in the section of the single bevil wheel, fig. 42, is attached upon a round fitting, secured against a shoulder or flange upon the crank, by a screw and nut behind; it is prevented from moving upon the crank shaft by a stud fixed in the face of the flange, which enters a corresponding hole pierced in the face of the wheel.

Occasionally the cylindrical crank shaft is without a flange, and is either filed with a flat, or provided with a slot or key way; the circular fitting in the wheel has a corresponding rectangular slot, filed slightly taper, and the two are fixed together by an iron key, fig. 41. The crank shaft is sometimes left circular, the under surface of the key is then fluted to fit it. One or two light blows of a hammer upon the end of the key, effectually secures the wheel, and it is as readily loosened by driving a taper punch or chisel between the face of the wheel and the head of the key. Of these two methods of fixing, the fluted key is the less secure, but it includes an element of safety well adapted for the driving gear of machinery; the key, may be just sufficiently tightened to do the work, but immediately slips in the case of accident or undue resistance. When a lateral adjustment of the wheel upon the crank is desirable, the end of the crank shaft may be turned as a square threaded screw, the wheel fits this by a plain hole and is traversed and secured by nuts upon either face; an arrangement adopted in fig. 114.

Cranks of foot lathes to about five feet in length, are by preference made with a single bend or throw; but above that length, they are more usually made with two throws, dividing the crank shaft into three, about, equal lengths; principally necessary to afford a second support to the long treadle, which would deflect or "rack" if supported only at the center as in fig. 43. In all convenient cases, it is desirable to avoid the use of the double throw crank, which for light and smooth running requires exact vertical and horizontal parallelism in the two necks for the hooks. This is liable to disturbance, from original defect in manufacture, from elasticity, or from inequalities in the material, any of which may set up irregular

wear in the crank, its hooks or centers; frequently causing the double throw crank to "grind" and to work much more laboriously than that with the single throw.

The crank has been made to run in bearings, on centers, and upon various combinations of anti-friction rollers, many of the latter very complex, but all offering but little advantage. It is now usually made of round iron steeled at the ends, in which the hollow centers are first bored with a small deep hole, and are then coned to an angle of about 60° . The crank is supported upon screwed and fixed steel points turned to a corresponding angle; the extreme points of the centers being free, and received by the small hole bored at the apex of the hollow center, which also serves to retain the oil for lubrication. The center screws of the crank and treadle are screwed up moderately tightly, until upon shaking the crank lengthways, the knocking that arises from excess of distance between the end screws just ceases; an increased and laborious friction is felt directly the centers are screwed up too tightly. Should either the wheel be loose upon the crank, or the treadle insufficiently screwed up, the circumstance is indicated by a sound resembling a knock, occurring at every depression of the foot.

The treadle of the foot lathe has been constructed in various forms and as levers of each of the different orders. For a long period it consisted of a straight piece of wood, one end jointed to the floor, and the other, attached to the cord from the pole or wheel, figs. 20, 22; this straight piece being crossed by a second for the foot. The piece for the link or cord was then fixed about parallel with the lathe axis, fig. 32, that for the foot being retained as before, or sometimes abandoned, when the treadle consisted of a single bar. The link to connect the crank and the treadle has consisted of a cord, a leathern thong, a chain, and a metal rod or hook, while elaborate contrivances of bearings in halves, universal joints and screw adjustments, to determine the exact distance of the treadle from the ground, were sometimes adopted.

The general form of the modern treadle is given by fig. 43, and some varieties of its construction may be found in later illustrations. The modern treadle is continued beyond the

hook, which is attached about the middle of its length, and the width is considerably increased by the footboard attached by rails to the axis at the back. The hook is generally of iron, steeled at the working parts, a thin strip of metal being sometimes attached to its upper edge to exclude access of shavings to the crank; the lower hook shown, is now usually exchanged for a plain hole which cannot separate from the steel pin upon which it works, unless the latter is intentionally withdrawn.

Fig. 43.

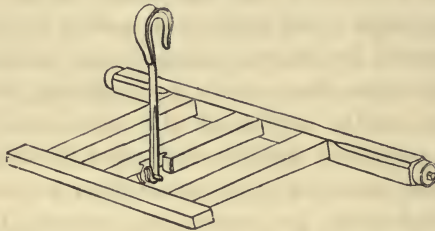

When the lathe is at rest, the bend of the crank hangs downwards and the length of the hook should then permit the footboard of the treadle to hang just clear of the floor. In starting the lathe into motion, the foot is placed on the treadle, the driving band is taken between the finger and thumb of the left hand, just below the mandrel pulley, and pulled downwards; this causes a semi-rotation of the fly wheel, turning the bend of the crank upwards, and then as the latter passes the perpendicular, the pressure from the foot is first applied to the treadle; upon which the wheel at once takes up and continues the motion.

To avoid the necessity of starting the lathe in this manner; it is frequently recommended that the fly wheel should be sufficiently weighted at one part of its circumference, to overbalance the weight of the treadle, that when the lathe is at rest, the bend of the crank may stand nearly horizontally instead of hanging vertically. The footboard of the treadle then hangs a few inches off the floor, and the lathe will start into motion immediately the foot is placed on the treadle, without its being requisite to touch the band.

This practice is to be deprecated; as the unequal disposition of the weight upon the wheel, is most injurious to its

momentum. The fly wheel can no longer convert the unequal forces applied through the crank into perfect uniformity of motion, but compelled by the weight that has destroyed its balance, it may be said to register every separate revolution; the vibration introduced by the weight, being distinctly felt in every revolution of the lathe and seen marked in the varying quality of the surfaces turned upon the work. Besides the foregoing objection, the counterpoised wheel is a disadvantage for delicate or precise work, and the lathe to which it is applied always shows a disinclination to stand perfectly still; necessary for the adjustment, measurement or fitting, constantly required for ordinary small works in wood or metal. The lathe can be made to rest quiescent, provided the weight be in excess, but that only increases the former evil, and even then a slight accidental touch on the treadle will set up some motion. When long and heavy treadles are employed, there is some advantage in their weight being partially balanced; but the counterpoise should be applied to the treadle itself, when it can in no way interfere with the momentum of the wheel. In the slide lathe fig. 114, the back of the treadle is sufficiently extended beyond the centers upon which it works, to partially neutralize the weight of the front.

An exceptional form of treadle carrying the hook or link horizontally fig. 44, has been tried. The hook is jointed to the end of a strong bracket affixed upright on the treadle, and

Fig. 44.

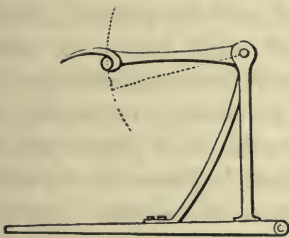
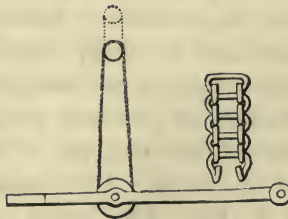

Fig. 45. Fig. 46.



terminates in a sort of curved finger which rests against one side and on the top of the neck of the crank. The action is nearly the reverse of that of the ordinary hook, the crank being pushed forward instead of being pulled downward. Mr.

Lukins, the inventor, thus described the advantages he claimed for it: "A crank with a short connecting rod, turns one of its dead points much more quickly than the other; advantage is taken of that peculiarity in the arrangement of the crank in this lathe. The slow turn takes place at the bottom of the tread, and the too quick return upon the foot which occurs in the common mode is consequently avoided."

When tried practically, this treadle proved far less smooth and agreeable in its action than the old form; the quick return is transferred to the top of the circuit, whence it gives a jerk and vibration to the knee and body not experienced with the ordinary hook, which appears to have been altered but not improved. Another treadle has been recommended, on the score of the footboard being hinged, so that it may yield in the event of the foot being accidentally placed beneath it; the treadle is weakened and the alteration appears hardly necessary.

In the late Mr. Clement's treadle fig. 45, the crank has a wide flat neck, or carries a small pulley, and the pin on the treadle is replaced by a larger pulley, the hook being exchanged for an endless chain. The chain rolls around the neck of the crank and the treadle pulley, and was considered by Mr. Clement to produce less friction than the hook; this arrangement is sometimes adopted. There is a smooth and agreeable action in the chain, but its elasticity and stretching under the pressure of ordinary work, greatly detract from its apparent advantages; the friction of the numerous pins as the chain bends around both the crank and the pulley, is also but little less than that of the steel crank hook, the rigidity and durability of which offer great recommendations. The flat chain employed is stamped from sheet metal, the links being formed of odd and even numbers of plates joined by pins, the smallest example of which is found in the winding chain of the watch. Its manufacture is described pages 939, 940, Vol. II. The chain known as Vaucanson's chain fig. 46, each link formed of round wire and capable of detachment, so as to vary and adjust the total length, is also conveniently used as a driving chain, for this and many other purposes.

SECTION V.—DRIVING LINES AND BANDS, SPLICING AND COUPLERS.

The driving bands of foot lathes have been made of cord or rope, of catgut; of plaited horsehair, leather or catgut; of round and of flat leather, of gutta percha and of other substances. Of all these, catgut, from its durability, comparatively slight tendency to expansion or stretching and from the convenience of its form, has obtained general and almost exclusive use.

The ordinary catgut of commerce is manufactured in lengths of about seven yards, twisted as a single strand; it has a smooth, uniform, external surface and is hard and solid to the center. Extensively used for a great variety of purposes, it is made of many sizes, ranging from $\cdot 025$ to about one inch and a half in diameter. The different sizes are distinguished by their diameters expressed in parts of the inch, from the largest to five-sixteenths, and below that size by the numbers of the Birm. Wire Gage, page 1013, Vol. II. Catgut for the driving bands of foot lathes varies from about one to three-eighths of an inch diameter.

The power of a catgut band in the transmission of motion, depends upon the correct proportion of its size to the work it has to perform, and the extent of its wrapping contact upon the wheel and pulley. The diameter should be just large enough to prevent the band quite reaching the bottom of the groove in which it runs; the surface contact is then increased, while additional hold is obtained by the band to some extent wedging in the groove. In the case of wood pulleys, the grooves soon wear to fit the band, which then takes a semi-circular bearing, and the increased surface contact thus obtained largely compensates for the loss of the angular grip. Undue width in the grooves, necessitates a band of larger and disproportionate diameter, which excess of size causes increased labour in the continual bending of the band. On the other hand, deficiency of size has to be counteracted by increased tension, which for many reasons is highly detrimental.

The two ends should be joined with the least possible addition to the dimensions of the band, for any abrupt enlargement by the joint is objectionable, causing a

concussion in its revolution, every time that it runs *on* to the wheel and *on* to the pulley. The shocks caused by an abrupt or thick joint, are felt as a series of blows, more severe upon the pulley than on the wheel; every blow imparting a slight jerk to the work, with a consequent interruption of continuity of *amount* of cut by the tool, plainly visible on the surface produced. With pulleys of small diameters, especially on those employed for driving revolving cutters, such an enlargement of the band seriously interferes with uniform revolution; the jerks given to the tool leaving sensible marks and almost ridges upon the work.

The ordinary methods, of joining catgut bands are by splicing, or by hooks and eyes; occasionally they are sewn or joined by wire, spirally or as rivets. Almost any methods of joining the ends of the band, must of necessity form an enlargement of its diameter; and therefore so far as possible to avoid the inconvenience above referred to, the joint should be made to gradually taper away to the size of the band, so that it may insensibly run on to the pulley when it is scarcely felt.

Catgut being formed of only a single strand, splicing does not admit of much variety; the splice should be made in the manner shown by figs. 47 to 51. Spliced catgut which is usually of moderate dimensions, is first well stretched in length, in the following manner. One end is fixed in the vice, and the loose end is held and strained by the left hand, one or two turns having been first taken with it around a tool handle, which is held in the right. The operator walking gradually backwards, pulls on the band and at the same time causes the tool handle to traverse several times to and fro, in every foot of the length.

The measure of length around the wheel and pulley of the lathe is taken with a piece of string, and according to its diameter, the catgut is cut from about six to eighteen inches longer, to allow a sufficient margin for the splice. The splice is commenced by two holes which are made with a conical steel point or small marlinspike, transversely and through the center of the catgut; and to allow for subsequent stretching, at a distance apart that would be about one inch less than that required for the length of the finished lathe band. The two ends are then passed through these two holes fig. 47, and

drawn tight as in fig. 48; the splitting of the catgut by the holes, and filling these by the ends, causing an irregular enlargement of the band. Two other holes are then pierced in the band at right angles to the first pair, and the ends are passed through them in like manner, fig. 49; the two ends being placed through from the opposite sides of the band, and then drawn tight as in fig. 50. Both the free ends are then unravelled, and about a quarter of their substance is cut away from each, the portion taken being removed by a long sloping cut, from the *inner* side *next* to the splice; thus reduced, the ends are then neatly retwisted and passed through two other slightly smaller holes, pierced as before transversely to the last, and again pulled tight. The operation is several times repeated, every time with a further

Fig. 47.

Fig. 48.

Fig. 49.

Fig. 50.

Fig. 51.

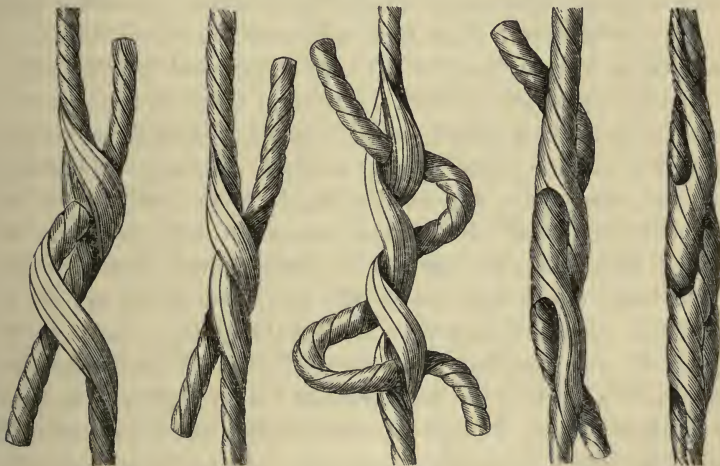

portion cut away from the ends, until these become gradually and considerably attenuated, causing the splice to taper very gradually both ways from its center; the diminished ends after being passed through the last holes are cut off level with the surface. The completed splice fig. 51, is then laid across a flat surface, generally the lathe bearers, and lightly hammered on all sides to equalize the irregularities into a more uniform taper; the hammering being also frequently resorted to during the earlier stages of the splicing. The finished band does not

usually run upon corresponding grooves, but is placed on the pulley upon one or perhaps two grooves too small; but it soon stretches to the correct length. Splicing is rarely used for large bands, which are generally joined by hooks and eyes; but

Fig. 52.

Fig. 53.

Fig. 54.

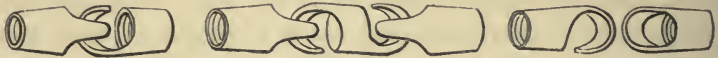

it is a very convenient mode of joining the smaller bands, to some of which, from the gradual increment in the joint, it is indispensable. It has the drawback that the band cannot be so readily removed, sometimes indeed not at all, as when it passes through apertures in solid portions of the machine.

The hooks and eyes for joining catgut bands, figs. 52, 54, are made of steel, they range in size from about one and a half inch to one sixteenth of an inch in diameter, and have the externally taper, tubular portion cut with an internal parallel screw thread for their attachment. The long taper of the splice is imitated to a small extent by their external taper form, which, largest where they affix to one another, gradually diminishes to very nearly the size of the band at the orifices for its attachment. When well made, tempered and properly attached they work and endure exceedingly well and they are extensively used; but the hooks and eyes being unable to bend like the band, they pass around the pulley as tangents to its circle, and therefore when the pulley is of small diameter they have a tendency to bend the band at an angle and to wear it by their edges. The greater the length of the hooks and eyes the more active does this wear become, and to diminish it, they should be made of no greater length than is requisite to obtain a sufficient and permanent hold upon the end of the band.

An attempt to increase the agreement of the hooks and eyes with the circle of the pulley, was made by Mr. Nicholls and rewarded by the Society of Arts. Mr. Nicholls joined the band by two short eyes and a double ended hook fig. 53. The passage of these couplers on to the pulley was somewhat less perceptible and there was less wear on the band, but the loss of the loose hook was so frequent an occurrence, as almost to counter-balance these advantages. The short length in proportion to

the diameter, and the taper form to which the ordinary hooks and eyes can be made, also very nearly approaches to the advantages of fig. 53, without the drawback of the loose piece.

The principal wear in these couplers, figs. 52, 54, takes place upon the inner portions of both hook and eye, and these should be left of considerable thickness. The hook should also nearly reach the tube, the opening between them being very narrow, and the sides of the eye should be filed correspondingly thin to pass in by this opening; made in this manner, the two can only be joined or detached when at right angles and are not easily separated by accident.

To affix the hooks and eyes;—the catgut having been well stretched, is cut to about one inch short of the required length of the lathe band; the two ends are then pared with a knife to long, taper and equally round points; these are screwed into the hook and eye, which are held by a hand vice, or if they be large, in the bench vice; the slack of the catgut being wound around the hand to obtain sufficient purchase. At first, the taper point readily appears through the hook or eye, filling the cavity beyond the screws; this portion is cut away with a penknife and the point screwed further in, and it may again require cutting away if it appear that still more of the catgut can be screwed in. The point is finally burnt off, by a nearly red hot wire, inserted to entirely clear the cavity of the hook or eye; the hot iron also swelling and hardening the end of the catgut and rendering the hold much more secure. The uniformity of the point cut upon the band, has very much to do with securing a permanent hold; the band and the hook then have one axis and the point of the catgut is equally compressed by the screw. On the other hand, should the point be cut to one side, the screw draws to that side, the edge cutting into and weakening the central substance of the band. It is also very possible in the act of attaching the hooks and eyes, to entirely destroy their hold, which occurs from overscrewing the band when they are already sufficiently affixed; the effect being to twist off the thread cut on the catgut, which is left in the screw, the two coming apart. The thread of the hook or eye has then to be completely cleared out, prior to recommencing upon a fresh point to the band.

Catgut driving bands are subject to a moderate variation in

length from atmospheric changes, they become more or less slack in dry weather and shrink and tighten with wet. For those of great length running over several pulleys, some compensating or stretching arrangement is adopted; but the extent of the variation in the lathe bands, may usually be compensated, by shifting the band to different speed grooves on the pulley. For this purpose it is very convenient that the series of speed grooves on the pulley and on the fly wheel, should not precisely agree as to bevil or angle. The band may then always be shifted to a different pair of grooves, which obtains the required tension; and if it be very slack, it may be shifted on the grooves either of the pulley alone, or only on those of the fly wheel.

It should also be remembered that among other reasons, to prevent unnecessary wear and friction in the mandrel, that the driving band should be only just sufficiently tight to carry round the work in progress. A slight additional tension, less than that resulting from varying the position of the band as above, may be obtained if the band be unhooked, and the one end turned or twisted several times and then rehooked; this slightly shortens the length and gives a small additional hold. This practice is very convenient to the billiard ball turner, who works with a very loose band, that he may frequently arrest the work for momentary examination, by laying his hand on the pulley without stopping the revolution of the lathe.

The driving bands of foot lathes are usually open, that is, they pass around the wheel and pulley as a single loop, but they are occasionally crossed as a figure of eight to obtain a greater wrapping contact. In each case, according to the tension of the band, there is a downward pull upon the pulley, causing the friction of the mandrel to take effect principally upon the under side of the collars. Practically, little inconvenience arises from this cause, and it but rarely claims attention. The friction of the old pole lathe was equal, the pull being neutralized by the cord passing away in opposite directions; analogous methods of reeving the band have been applied to the mandrel to obtain the same advantage.

The grooves of the wheel, the mandrel pulley and the tension pulley in fig. 56, are turned in pairs of exactly the same diameters, the band following the course shown by

fig. 55. The strain of the two parts of the band upon the mandrel being opposite and equal, is neutralized; while the purchase is doubled, by the band embracing the entire circumference of the mandrel pulley, so that half the tension will suffice. There are only two speeds to the mandrel pulley, fig. 56, but this requires two pairs of grooves on the wheel and two pairs in the tension pulley; each pair being strictly alike in diameter, as otherwise the band will slip around some of them and a part of the intended reduction of friction will be lost. Fig. 59, is a more simple method using single

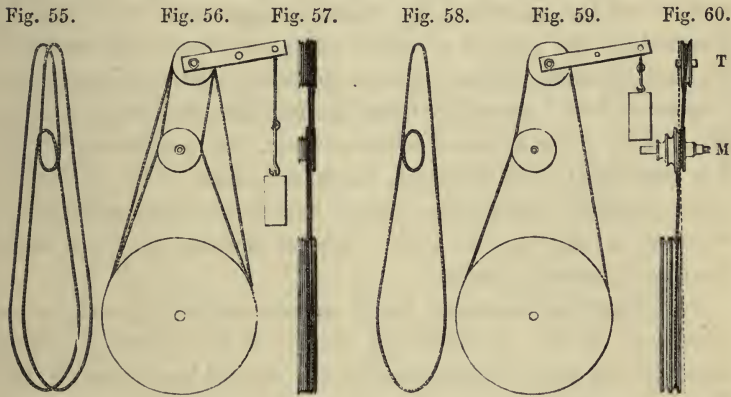

grooves upon the pulleys, and is almost a copy of the cord of the pole lathe. The band passes from the wheel to a tension pulley embracing the mandrel in its course; the mandrel pulley has three or four grooves for different velocities, and the fly wheel and tension pulley are placed a little to the right and left of the mandrel groove, so that the two ends of the band are led away in opposite directions without fretting each other. None of these arrangements however, are found to offer sufficient advantages to warrant their application to the ordinary foot lathe.

CHAPTER III.

LATHES WITH REVOLVING MANDRELS.

SECTION I.—MANDRELS MOUNTED IN WOODEN HEADSTOCKS.

THE lathe in which the work alone revolved between fixed center points, received its greatest improvement in the introduction of the mandrel, by which arrangement the work is attached to the end of a spindle, the two revolving together. The old French writers, styled lathes provided with mandrels, "tours en l'air," evidently from the freedom and independence of the work; the whole of which, except the portion by which it is attached to the mandrel, being accessible. The adoption of the mandrel opened the way to the very considerable development in chucks and other lathe apparatus, that has since been continuously effected.

The revolving mandrel would appear to have arisen as an extension of the arrangement employed for turning hollow objects; the germ being found in the spring bow lathe fig. 22. The gem engraver drawn by Schopper, 1568, uses a mandrel lathe, and Felibien pages 379, 380, thus describes the use of the mandrel in turning, he says, "For turning hollow work, such as vases, one of the center heads is removed, and a thin wood or iron collar with a round hole is substituted. The collar also serves to support mandrels or arbors, pieces of wood made in the form of pulleys or otherwise, against which are fastened, either by cement, or the points of nails or screws, or in any other manner, certain works that cannot be turned between two points, such as boxes and many other things."

The wooden mandrel was before long replaced by a light rod of iron, having a center point at the one end and formed into a screw at the other; the latter being introduced as a more convenient attachment for the work than the nails or cement. The iron mandrel, fig. 61, copied from Bergeron, was surrounded by a tube or casing of wood, turned to two or

more diameters separated by enlargements of the material, the first to vary the speed, and the last to guide the string of the pole or bow; the screw end running in a hole in the guide plate fig. 22. Subsequently the mandrel was provided with

Fig. 61.



one or two rings or flanges of iron and was placed to run between divided wooden collars, joined like a pair of compasses to permit occasional separation for its removal.

The iron mandrel was but a short time in use before it was also employed for cutting screws mechanically; the majority of the early mandrels taking that form. Plumier describes an iron mandrel which is of interest as exhibiting the divided wooden collars, and also as showing the first application of the traversing motion, together with the method he employed for cutting the guide screws.

The following is condensed from our author's account of the process. He directs the mandrel to be forged, annealed and

Fig. 62.

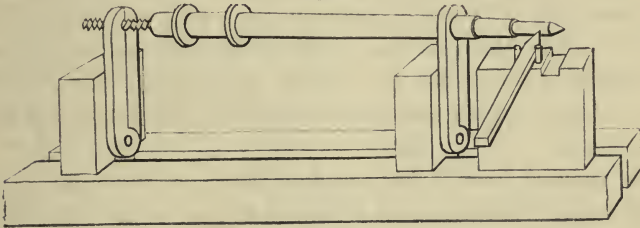

very carefully centered, and then to be turned true in a strong center lathe with heads of small elevation. The mandrel is then to be supported after the manner shown by fig. 62, while the hole that is ultimately to receive the chucks is being drilled. He condemns the use of die stocks, for the formation of the screw guides, to be next cut upon the mandrel, from the risk of bending that, or of cutting these screws out of truth, and recommends either of the following as superior methods.

By the first, an angular slip of paper is to be very accurately coiled around and then cemented upon the mandrel; and the

margin forming the line of the screw, is to be carefully followed by the edge of a thick knife, to cut through the paper and mark a fine screw line on the iron; which line is to be enlarged with a delicate fine edged file, and then by one of triangular section. The mandrel so far prepared by hand is then to be placed between centers and the screw completed during its revolution, with the file or with a screw tool filed by hand to the same intervals or thread. A very similar method of originating screws was still sometimes employed so late as about the commencement of this century, particulars of which are given page 579, Vol. II.

The second method described and preferred by le père Plumier is shown by fig. 62. The hole drilled for the internal screw for the reception of the chucks, is temporarily used to hold the shank of a tap, of the same thread as the screw guide required, the tap being fixed in the mandrel by tin solder, so that the two may be exactly in one line to possess a common axis. They are then supported in jointed semi-cylindrical wooden collars, the tap being allowed to cut a thread in the one pair, to serve as a guide, and to cause the traverse of the mandrel during its rotation. The pointed tool used to cut the external screw guides upon the mandrel, is held on the rest by the hand, but to retain it stationary two pins are inserted or a notch is cut in the rest the width of the tool, as represented. The internal screw for the chucks was obtained in a similar manner being copied from one of the external screws cut upon the mandrel.

The general form of the mandrel lathe, so far as the wooden bench and headstocks were concerned, was for a considerable time modelled upon that of its predecessor the pole lathe; the mandrel head alone was altered, being duplicated and modified to receive divided collars of lead or tin, cast in dovetail recesses, these collars being much like the divided metal bearings now generally employed for machinery. The plain mandrel was forged entirely of iron with a cylindrical neck or pivot at either end, that in front having a projection or shoulder for the chucks to screw against; the central portion was forged square and slightly taper for the wooden pulley. After the necks had been turned true between the heads of a center lathe; the mandrel was placed in the perpendicular recesses of its wooden

pedestal, still supported by the points of the center or pole lathe, and melted lead or tin was poured in to fill the space between the wood and the mandrel, to form the lower halves of the collars. All the parts were then dismounted and the half collars filed down to the diameter, after which the half collars and mandrel were replaced, to cast the remaining halves to form the entire bearings. These were completed by cross pieces above, attached to the heads, having central pressure screws to retain the two halves of the collars in contact, and to supply a compensation for wear. In casting the collars, the

Fig. 63.

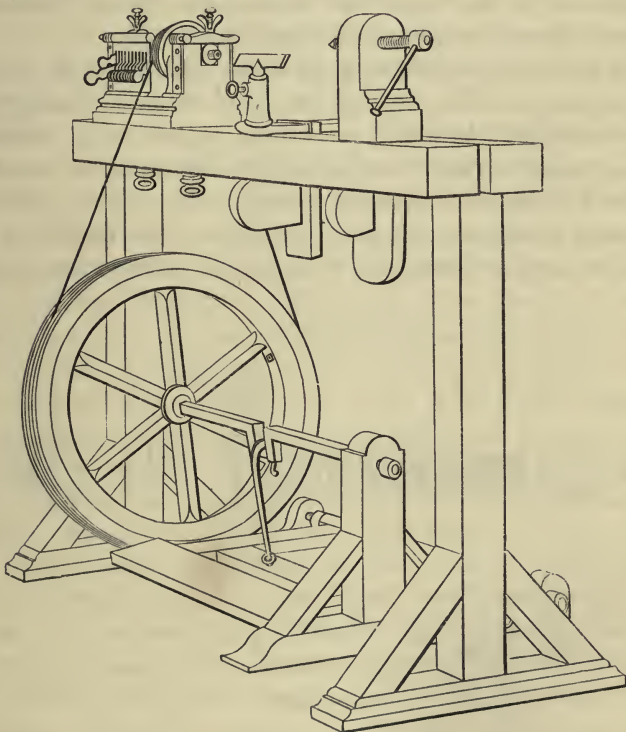

mandrel required warming nearly to the temperature of the metal, to avoid chilling the latter before it had entirely filled the apertures; these also had to be effectually stopped to prevent the metal escaping, by plates of wood filed to the

circle of the mandrel, tied on with wire and cemented with clay.

The mandrel and its cast collars ensured truth in two important particulars, which were thus within reach, when the modern exact tools for boring and turning these parts were unknown. The center lathe obtained the truth and the respective agreement of the two cylindrical pivots of the mandrel, which had one common axis; while the same equiaxial character was assured to the collars which, being cast to exact coincidence with the mandrel, assumed in the most easy manner the same degree of perfection. Lead, tin and fusible alloys, are still constantly employed for numbers of temporary adaptations in the workshop, as also for similar permanent bearings where economy of structure is desirable.

The iron mandrel running in metal collars cast in wooden receptacles, and the wooden keys and wedges employed as counterparts for the guide screws, are among other examples of the gradual change from the wood to the metal construction. A later French screw mandrel lathe, fig. 63, with tin collars in a wooden headstock, is a good specimen of the transition age, in which wood and iron, screws and wedges are curiously inter-

Fig. 64.

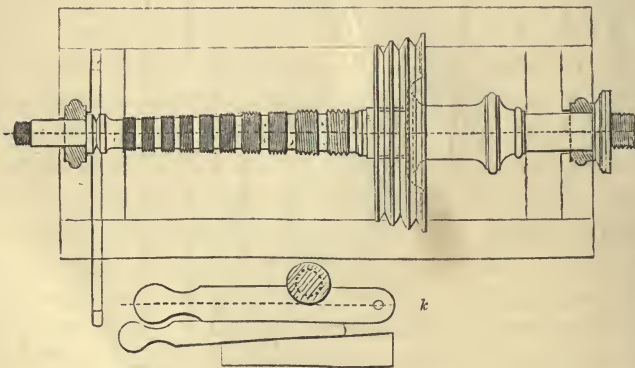

mingled; the iron wheel also exhibiting the wooden rim previously referred to. The mechanism of this traversing mandrel was illustrated page 613, Vol. II., in the chapter on screw cutting tools, and the woodcut fig. 64, is reproduced for convenience of reference. It shows the lathe head in plan on a

larger scale, the upper parts being removed to exhibit the tin collars which are shaded. When the mandrel was used for ordinary turning, the two rings formed upon it, that behind the screw for the chucks and that towards the back end, were close up against the faces of the tin collars; a retaining key, *k*, attached to the inside of the back of the headstock preventing the mandrel from traversing, the angular and circular edge of the key, entering a groove turned for its reception in the back ring.

All of the ten threads cut upon the mandrel are provided with similar keys, somewhat wider, with their circular arcs cut with corresponding internal screw threads. In screw cutting, the retaining key is depressed and one of the screw keys is raised by its wedge to engage in its corresponding screw guide, when as the mandrel revolves, its cylindrical necks permit it to traverse to and fro in its tin collars, in the exact path of the screw guide selected. The mandrel and work pursuing the same compound movement, a fixed tool cuts a screw upon the work, a copy of the thread which occasions the traverse of the whole, but of any required diameter. The manner of using this apparatus is described in a later chapter, the work is chucked and the tool applied as in plain turning, and the mandrel receives an alternating backwards and forwards movement, to set up a traverse a little short of the length of the screw guide being copied. The action of the pole lathe was in every respect suitable to the production of this reciprocatory motion, and was also somewhat more convenient than the foot wheel now used, to which only a partial revolution or a swinging motion has to be given by the treadle.

The lathe head in most general use in this country at the commencement of the present century, fig. 65, had the mandrel forged from a square bar of iron, the front end being turned to a cylindrical neck, with either an internal or external screw for the chucks; the opposite end was pointed and a wooden pulley was fixed about the center of its length. The neck of the mandrel revolved in a cylindrical hole bored in a rectangular metal plate, which was either of brass or iron, and was fixed to the front of the wood block or popit by a screw bolt and nut. The back half of the head stock was divided vertically, and had a transverse bolt and nut to fix the back center screw,

when that had been adjusted to support the point of the mandrel.

This variety of the mandrel, with its combined iron and wooden headstock was also arranged for cutting screws and is still used for that purpose. It is made of circular section, cut with screw guides and provided with keys and wedges, after the same manner as fig. 64. The traverse is arranged by making the cylindrical neck longer, so as to project about an inch through the front plate or collar when the lathe is used for plain turning, with the mandrel supported by the back

Fig. 65.

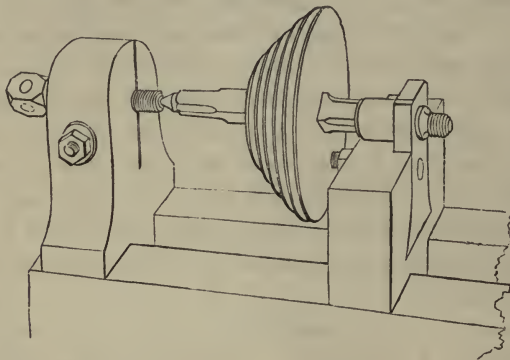

center. For screw cutting, the key or guide is first lightly wedged up to the mandrel, the back center screw is then withdrawn about an inch; after which the mandrel lies under the control of the screw guide cut upon its shaft, which rests upon the screw key. This arrangement fig. 66, although analogous to, is decidedly inferior to the French, being only under the control of one collar and supported by the key. The key re-adjusted every time it is employed, is liable to unequal wear, which may cause the mandrel to stand slightly obliquely to the collar during its traverse and to enlarge and wear that out of truth. The screw key of the French mandrel on the other hand, only controls the screw traverse and acts in no way as a support; while the two bearings of the mandrel cause that to revolve in a constant line with comparative certainty, without unequal wear upon the collars.

The screw mandrel last described is known as the Tunbridge screw engine, and may still be found in limited use by the Tunbridge ware turners and others. All lathe mandrels mounted in wooden headstocks however, are more or less subject to change of position from atmospheric causes, which

Fig. 66.

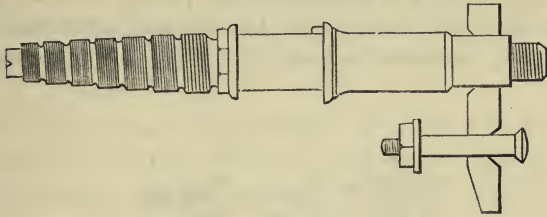

renders them unsuitable to works of accuracy, and the construction may be considered nearly obsolete. But, together with other lathes of rather rude and early fashion, they are occasionally met with in daily use, and doing good service and often side by side with more modern examples; the original form of construction having been perpetuated, by repeated repairs or replacement of worn out parts.

SECTION II.—BAR AND BED LATHES.

The mandrel mounted in headstocks entirely of metal, succeeded the various constructions glanced at in the preceding section. The superior accuracy and strength attained brought about other structural improvements, among the more important, being the final exchange of the table like top with its long mortise to receive the tenons of the lathe heads, for various forms of lathe bearers.

Several of the latter formed of strong, rectangular, wooden beams, appear among the previous illustrations, and when of suitable strength and material are not only very well adapted to many purposes of plain turning, but they are also still largely used. Wooden beds sometimes receive a quasi-improvement in metal plates screwed to their surfaces; but the two materials are liable to constant relative change, while the metal plates, although fixed down to the wood, frequently yield differently at various parts under the pressure of the lathe

heads ; little, if any increased truth is obtained and but slightly increased durability.

The surfaces of the wooden bearers could be wrought straight and true with comparative ease, but this was not the case with the original metal beds, made at a time when the planing machine was yet unknown. The chipping chisel and the file, with straight edges of very moderate quality for their guidance, were at that time the principal tools in use, and these rendered the simplest structure advisable. The earlier improvements

Fig.

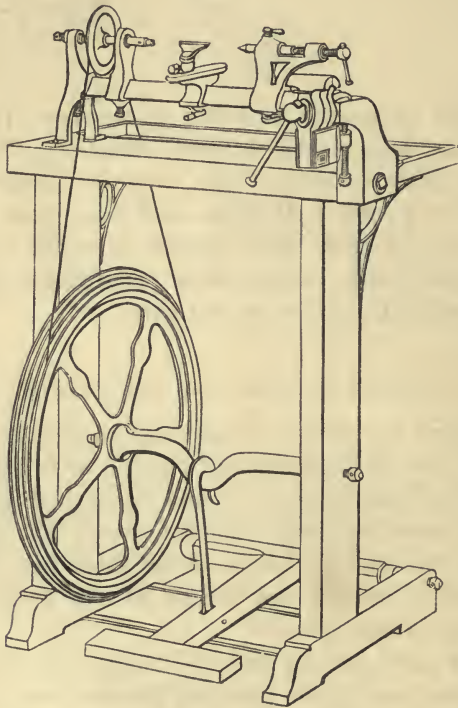

in the lathe in this direction, were mainly due to the late Mr. Maudslay who produced one of the first, if not the original bar lathe : the form of which, appears to have been influenced and in some degree modelled from that of the turn bench. The selection of the triangular, in place of any other section for the bar was exceedingly judicious, for if only two sides or

planes of the prism be made tolerably flat and correct, they meet at a constant angle and the angular pieces or saddles of the headstocks, fit equally well and stand in exactly the same positions to each other throughout its entire length. It is also quite immaterial, whether the third or lower face of the bar, forms equal angles with the other two or not, or whether it is even parallel with them, as it has only to serve to receive the pressure of the binding screws used for fixing the heads. The general form is shown by the small bar lathe fig. 67.

Except in the smaller sizes, the bar lathe in turn, has been almost superseded by the superior advantages offered by the iron beds or bearers; which, originally produced in like manner,

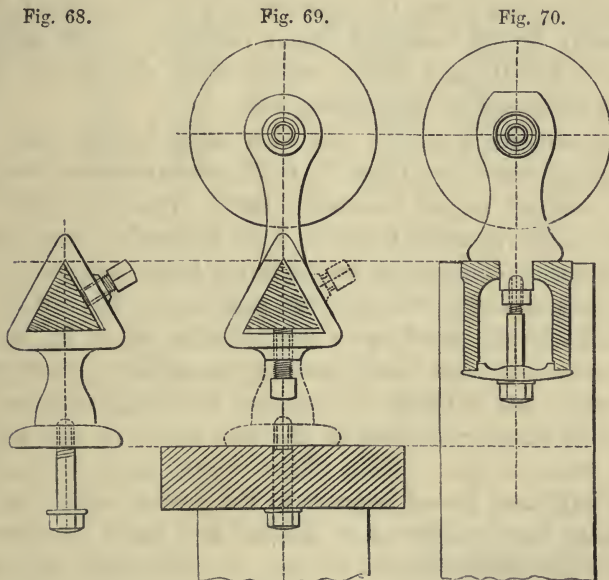

by the chisel and file, sometimes assisted by the hand plane fig. 330, Vol. II., are now planed in the planing machine, and then finished to any required degree of accuracy with the file, the scraper and the planometer. Figs. 68, 69, 70, are intended to afford a comparison of the sections of the two forms of bearers, of which the single or triangular bar is the more liable to suffer from torsion, the principal strain to which lathe

bearers are subjected. Torsion in the lathe bearers, causes the center of the lathe head to become slightly twisted over to the one side, and that of the popit head, to the opposite direction; which effect, the separated double bar of the lathe bearer is better able to resist.

The rectangular iron lathe bearers, fig. 70, were at first cast as two separate pieces which were bolted together at the ends. They are now usually cast in one solid joined at their extremities; while in very large lathes, the plan of the bearers presents something even approaching the form of a ladder, the two sides being connected at intervals by transverse pieces cast with them in the solid, giving strength to resist the torsion caused by heavy turning. The rectangular lathe bearers also attain considerably increased solidity from being attached directly to the standards of the frame, the interposition of the pedestal, shown separately fig. 68, being no longer necessary: such increased stability directly and visibly telling upon the quality of the surface produced by the turning tool.

The sections given to cast iron lathe bearers have been exceedingly varied, and figs. 71 to 76, an explanatory diagram, drawn without regard to exact relative proportion, give some of the more general forms. The triangular bar was the foundation of, and may be traced in the lathe bearers of earlier date, thus doubled it forms the section fig. 71. With this the lathe heads stood upon two angular edges by grooves, filed with some care along their under surfaces; their tenons were quite free between the bearers, but the grooves or base served to direct the axes of the two heads in one and the same straight line. This slight width of base does not afford sufficient lateral support to the heads, which with only moderate force employed in turning are liable to vibration; while exact parallelism in the two angular edged bars is also necessary. Improvement in stability was sought by making one side of the bearers flat and broad, fig. 72, with a corresponding flat on the under side of the lathe heads; retaining one angular side, to give the direction or common axis. This arrangement also facilitated the construction, as the parallelism of the two bars was no longer essential, the heads deriving their lateral guidance from the one angular side, and only resting upon the flat, the tenons being still free between the

bearers; the surfaces of the flat and angular sides are sometimes level and sometimes one higher than the other.

To increase the stability of the lathe heads, both surfaces of the bearers were then made as flats for their support; the direction of the heads being obtained by making their parallel tenons to fit the parallel groove in the face of the bearers. The

Fig. 71.



Fig. 72.



Fig. 73.



Fig. 74.

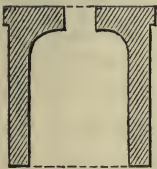

Fig. 75.

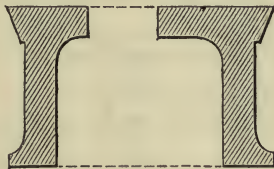
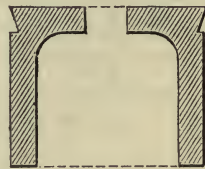

Fig. 76.



particular section of fig. 73, was due to the tools then employed, the narrow faces on the surface and between the bearers, being wrought by files and the hand plane; the lateral external projections, being only longitudinal ribs to stiffen the sides. Improved means of manufacture produced the modern form of lathe bearers, fig. 74, which, while compact in form, have wide, flat faces for the support of the lathe heads affording them all the stability attainable.

The bearers of large and long lathes are of greatly increased substance, proportioned to their increased dimensions, and are usually of the section fig. 75; the external, angular sides are required for guiding the traverse of the slide rest, while the projecting ribs along the lower edges to increase the stiffness are very frequent. The angular grooves at the sides of fig. 76, are adopted to avoid excessive width upon the face of the bearers of slide lathes, in cases where comparatively large internal space is required for the guide screw and clutch box.

The bar lathe fig. 67, has been occasionally constructed with the bar movable in the head, to adapt a lathe of small dimensions to turn work of increased length and diameter; in the manner shown by fig. 77. The lathe head has a triangular mortise in the direction of its length, shown by the dotted lines, this receives the bar, which is also supported by two pedestals attached to the lathe frame. The left hand pedestal having a horizontal traverse in a slot in the table of the lathe frame, so far as the dotted position. For work within the ordinary capacity of the lathe, the bar is supported within the head and by its two

Fig. 77.

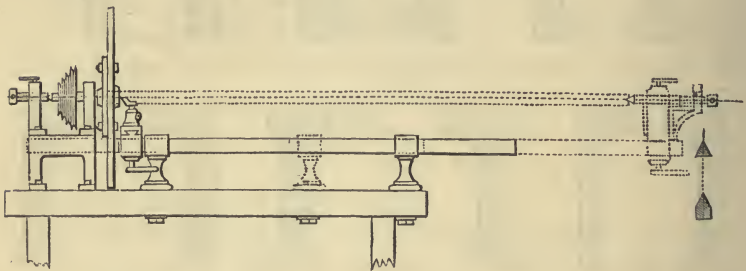

pedestals; for that of increased diameter, it is withdrawn from the lathe head and together with the movable pedestal, is shifted so far to the right as required by the thickness of the work. The tool rest, is carried on a short portion of the bar left projecting beyond the movable pedestal, and the work may be of any diameter, not exceeding the radius from the top of the bench to the lathe center.

For long rods, the movable pedestal and the bar carrying the popit head, are shifted still further to the right, as shown by the dotted lines; but as the tool rest can only travel the length of the bar, the work has to be turned end for end, to bring each half in succession within range of the tools; the half under operation being that most distant from the lathe head, which also suffers the most vibration. The popit head also so considerably overhangs the end pedestal, that it requires to be supported by a temporary prop or strut of wood from beneath it to the floor. The already small stability of the bar lathe is further considerably diminished in this arrangement, which apparently very convenient is not really satisfactory;

while this form of bar lathe, also presents a strong temptation, to habitually use the apparatus for works that are too large for its fair capabilities and strength. Long and slender works, such as are indicated by the dotted lines, also require some guide or stay to prevent them springing away from the tool. Somewhat analogous arrangements, for turning works that are of greater radius or of greater length than the normal capacity of the foot lathe will admit, are made in the ordinary bed lathe, the structure of which is much more favorable to the purpose; these and some varieties of the guides and backstays are mentioned in another chapter.

Increased capacity for diameter is frequently attained by making the bearers in two lengths, one only sufficiently long for the lathe head, the other as long as required, fixed with a small interval between their ends, both being placed in one line. Such arrangements are occasionally required by the wood turner, and more frequently by the engineer; by the former, usually for specific purposes, such as the manufacture of turned picture frames or other works of slight thickness. The oval frame turner frequently completely separates the two parts, placing the shorter portion of the bearer carrying the lathe head, at right angles to the longer and at about the center of its length; an arrangement very convenient for his purpose, obtaining a solid support for the hand rest, close to the surface of the work at all distances from the axis of the lathe. The height of the center of the foot lathe is most satisfactorily increased by the temporary employment of lifting pieces, hereafter mentioned, and this expedient not only meets the requirements of most of the occasional works, larger than the ordinary capacity of the foot lathe, for which the power of the latter is sufficient; but, it has the great additional advantage of leaving the length and the face of the bearers intact.

The break or gap lathes used by the engineer and usually driven by power, are principally intended for works of large diameter but of comparatively small thickness, and are employed for such purposes as that of boring the centers and turning the edges of wheels, or centers and bosses at the extremities of long pieces. In the smaller of these gap lathes, the bearers are cast in one piece, with a vertical bend or crank in front of the lathe head, fig. 78, the gap being closed by a

loose filling piece when the lathe is employed for ordinary work. This formation is not entirely satisfactory, the form of the bearers being less able to resist, while liable to increased

Fig. 78.

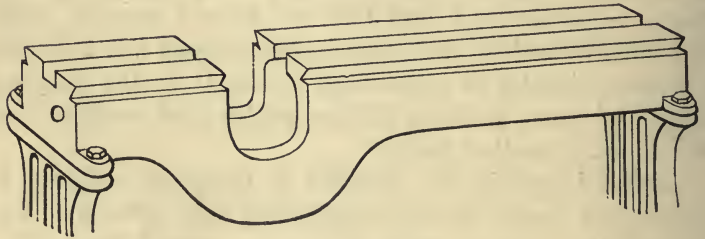

torsion ; the uprights and the bearers have therefore to be constructed of greatly increased weight and strength, for the lathe to produce a smooth well turned surface on the work.

The larger break lathes of the engineer are far more favorably constructed in all respects, the tall standards are absent, and the two portions of the bearers are bolted down exactly in a line on stone work and low iron pedestals, or else upon a heavy foundation of cast iron. When employed for work within the capacity of the height of center of the lathe head, the headstock sometimes stands over the gap and is bolted down to both portions of the bed ; or, a movable short length is used to fill the gap for the time ; or else, the two portions of the bearers have a power of longitudinal traverse and can be made to approach and join each other ; the headstock in the two latter arrangements standing always on its own short piece. The bearers are also sometimes cast as one piece in the form of a cross, with the entire horizontal surface at one level ; the two arms of the cross are close in front of the lathe head, and are hollowed as a trough to receive the work, the cross arm being also employed to carry the slide rest for turning surfaces.

SECTION III.—MANDRELS MOUNTED IN METAL HEADSTOCKS.

About the commencement of the present century, the turning lathe received material alterations and amendments from many different hands. Among them, the headstocks and the

square iron mandrel hitherto in almost exclusive use, were remodelled by the late J. J. Holtzapffel, 1794, who commenced by constructing the old wood formation of the lathe head in brass, a material at that time more easily worked than iron. His earliest structural improvement consisted in connecting in one the two independent pieces forming the headstock, which gave the base and the two uprights the character and advantages of three sides of a square. This rigidly maintained the coincidence given to the bearings or collars in their first construction, and produced so effective a reduction in lateral wear in the collar, that the improved form of headstock soon became nearly universal; while some of his early lathes may still be met with in satisfactory use. Subsequently, the advantages offered by cast iron and the comparative facility acquired in working in this metal, induced the same engineer to attempt the reformation of many other portions of the old wooden machine; which, as they became constructed in metal, were also divested of their rectangular outline hitherto used, and indicative of the carpenter's plane and the age of wood. The importance of the changes in the external form of the lathe however, may be considered as slight, in comparison with the alterations in the form and material of the mandrel, collar and other working portions of the mechanism, which also were all gradually made of steel.

The earlier iron mandrel running in an iron collar plate, fig. 65, afforded facilities for construction, but these were more than counterbalanced by its disadvantages. The wear between the cylindrical neck of the mandrel and the collar, arising from the section and from the unfavorable nature of the material, being also to some extent accelerated by the square section of the shaft. The work being firmly attached to the end of any lathe mandrel, the two may be considered to form one solid, and when the tool is cutting, to constitute a bent lever of which the mandrel collar is the fulcrum; but, as the other extremity of the mandrel is fixed and cannot escape laterally, the force or resistance to the tool is all exerted as if to bend the mandrel about the middle of its length. The square mandrel is found to yield differently in the resistance that it offers to the cut of the tool, as the revolution alternately presents its diagonal and its square section, and in some cases

the results may be visibly traced upon the work; while the variation tends to create irregularity in, and also to accelerate the ordinary wear that takes place between the mandrel and the collar.

Wear between any collar and mandrel causes the latter to float about at random laterally, to the extent of the difference of diameter that has arisen between the two, and this interference with the truth of revolution, is styled "play" in the collar. The disagreement will become in time both audible

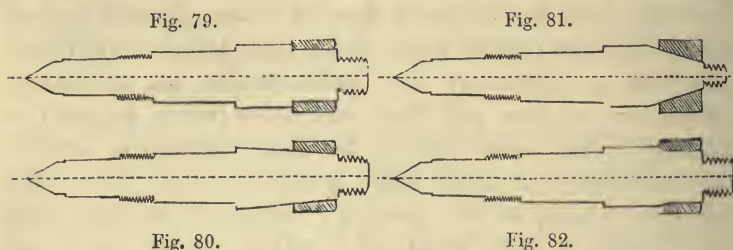

and apparent, and the mandrel instead of running silently then vibrates under the tool, making a low growling noise at small velocities, and a shrill rattle at high speeds; the vibrations of a much worn or ill fitting mandrel, also sometimes filling the surface of the work with waved lines or striæ.

The mandrel of circular section fig. 79, replaced the square, and as this section is always constant, such a mandrel exhibits no variation during revolution, and does not bend except from weakness; that is, when its proportional area is too small for its length. Wear was further reduced by making the collar and the mandrel of steel, and then still more by alteration from the cylindrical to a conical fitting; this latter, considerably delays disagreement in diameter, as the mandrel may be further advanced into the collar by the end screw to compensate the wear, as that takes place.

The cylindrical collar however, had the advantage of admitting the largest diameter possible for the screw for the chucks, and for the face of the mandrel against which they bear when screwed in their place, and this it was very desirable to retain. A mandrel made with an acute cone fig. 80, would allow the screw or "nose," and the face, to remain nearly as large as

before ; but this form is inadmissible, as it would wedge or set fast in the collar on revolution from the acuteness of the angle. A more obtuse cone fig. 81, could not set fast, but it would so far reduce the face of the mandrel and the nose, as to render the latter, weak and disproportionate to the dimensions of the former.

The form of bearing for the mandrel fig. 82, has two cones in juxtaposition, which avoids the inconveniences and combines the advantages indicated by these diagrams. The front cone is acute, differing but little from the cylinder, allowing a large diameter for the screw and a sufficient shoulder or face for the chucks ; the second cone is obtuse, of about the angle of 45° , and narrow in width, its bearing preventing the acute cone from wedging. The value of the narrow obtuse cone is very observable in this respect in the course of construction, when in fitting the mandrel the acute cone continually sets so fast in the collar, as to require a blow from a lead or tin hammer on the end of the screw to drive it back ; but this effect instantly ceases so soon as the obtuse cone takes its bearing. The angles and proportions of the back center mandrel and collar indicated by fig. 82, were adopted as the most successful result of an extended series of trials, made by the same engineer and his son, the late Chas. Holtzapffel ; they have since been very generally employed, while experience has shown their complete efficiency for lathe mandrels of moderate dimensions.

The particular section of the traversing mandrel for screw cutting, fig. 83, also originated with the same authors. This mandrel is cylindrical and of steel hardened at its bearings,

Fig. 83.

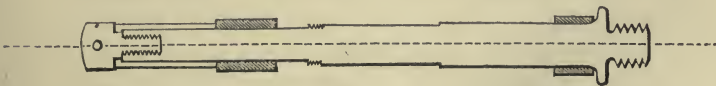

which work is hardened steel, cylindrical collars, shown shaded ; the obtuse or second bearing cone of the plain mandrel is present, but it is reversed and works in the face of the front collar. The bearing of the cone is ensured and end play prevented for plain turning, by a steel cap put on at the

back end of the mandrel and retained in position by the end screw; the face of the cap and the obtuse cone thus forming two shoulders, to exactly embrace the external faces of the steel collars in the headstock. Cylindrical collars are essential to permit the traverse for screw cutting, but the conical portions of the front collar and mandrel so far neutralize wear, that the traversing mandrel is very permanent and leaves little to be desired; together with its manipulation, it is further described.

The general types of the three principal varieties of mandrels used in the larger and power lathes, are given in figs. 84, 85, 86; which figures are intended to be viewed collectively, as an

Fig. 84.

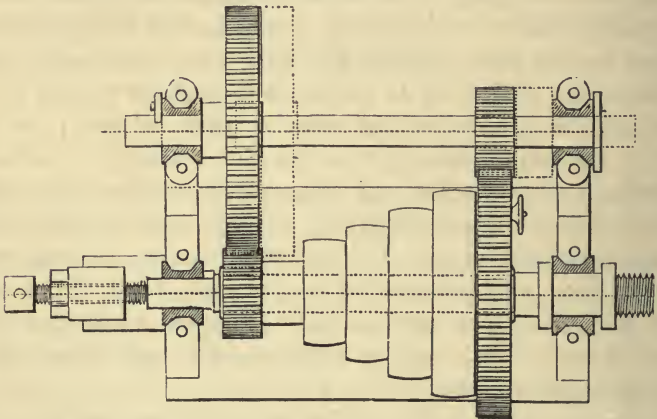

Fig. 85.

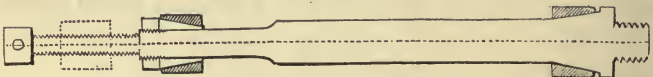
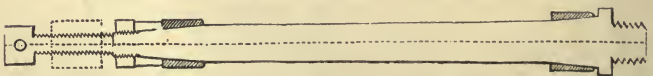

Fig. 86.



explanatory diagram, and are drawn without particular regard to exact proportions. The mandrel, fig. 84, works in brass or metal bearings, the upper halves of which are shown removed. Figs. 85 and 86, with their respective steel collars,

are drawn in section ; the pulley, wheels and pinions, and the general form of headstock are common to all three.

The mandrel, fig. 84, probably derived from the old mill driving shafts, is cylindrical at both extremities. The screw or nose for the chucks is large, and behind it the mandrel has two projections or flanges ; the first affords the face or shoulder for the chucks to screw against, the other rests against the front bearing, with which it is adjusted in exact contact by the end screw at the opposite extremity, tapped into the cast iron head-stock or secured by double nuts. The end of this tail screw and that of the mandrel, are both of hardened steel and very slightly rounded, touching only by a small central portion. The tail pin of whatever form, is a very important addition to the mandrels of heavy lathes ; it is constructed of appropriate strength to sustain nearly the whole of the endlong thrust upon the mandrel in boring and heavy surface turning, so as to very considerably reduce the surface friction, that would otherwise be entirely borne by the collars.

The mandrel fig. 85, was invented by the late Mr. Fox of Derby and is favorably known ; the construction appears to have arisen from the idea of a rod supported between centers, modified to expose the one extremity for the reception of the chucks. The shaded conical steel collars are permanently fixed in the cast iron headstock, the mandrel has the screw and shoulder for the chucks, then a large cone which fits the front collar, followed by a cylindrical portion to receive the driving wheels, and then a smaller cylindrical part upon which a loose steel cone is fitted, standing the reverse way to the former. The loose cone is keyed to the mandrel and revolves with it, it is adjusted by a double nut behind, which places the two cones at the distance required by the conical collars and prevents end play, and last of all, there is the tail pin as before. This, is still more necessary than in the previous example having cylindrical bearings, for in addition to receiving the endlong thrust in turning, it now also prevents the front cone from being jammed into its seat. The cone acting as a wedge, both increases the endway pressure, and squeezes out the oil that should remain between the mandrel and the collars for lubrication, and without the tail pin, their surfaces are exposed to the risk of heating and deterioration from the friction. The

adjustment of the tail pin in all cases should be only just sufficient to avoid undue friction in the collars, at the same time it should leave the mandrel under their guidance.

In the mandrel fig. 86, invented by the late Mr. Joseph Clement, for which he received the gold medal of the Society of Arts, all the working parts are of steel; the collars as before are fixed in the headstocks, but the two cones slope the same way. The cones of mandrels of this construction are carefully adjusted until they both bear equally, and this can be the more readily accomplished as the respective parts are in the solid, the two cones can be ground in at the same time, or the one or the other alone, as may be necessary. The mandrel is drawn down into its seat by a double nut behind, and supported as before by the tail pin.

The tail pin, sometimes called the "back stay for boring" is occasionally added to the traversing mandrel figs. 83 and 112; but from the comparatively light work to which the foot lathes are applied, it is not frequently essential. It is carried by a horizontal, transverse piece, which is attached by two short posts screwing into the back of the lathe head, on either side of the end of the mandrel. The tail pin is also frequently mounted in this manner upon the headstocks of the large power lathes, the strong transverse piece, being sometimes placed horizontally and at others vertically.

The single pulley upon the lathe mandrel, as already explained, is turned in grooves or steps of different diameters, the magnitude of which varies its leverage and determines the working speed and power. Increase in the diameter of the pulley is prevented by the dimensions of the headstocks and other circumstances, and therefore the limits are soon reached, within which a single pulley can be advantageously used in turning large and heavy metal works, upon the large mandrels lately described. These, usually set in motion by steam power, require additional driving apparatus of wheels and pinions in connection with their pulleys, to reduce the speed and obtain increase of power, and lathes so arranged are commonly known as "geared or back geared" lathes.

The same form of back gearing is also applied to foot lathes, to the larger of which it offers advantages; applied to the five inch and smaller foot lathes it is however less requisite or serviceable, much of the increased power being absorbed by the friction of the apparatus, while the character of work for which they are employed can rarely require it. With foot lathes of five inch or less in center, a slow speed with sufficient power is obtained without additional labour to the operator, by the simple expedient of running the band from a small bevil or slow motion on the fly wheel, to a large groove on the mandrel pulley. This method also presents a not inconsiderable advantage, viz., that of a smoother cut, arising from the absence of vibration caused by the toothed wheels of the back gearing.

The combination of wheels, pinions and pulley employed for back geared lathes, may be traced to those added to the old millwright's dead center lathe for heavy turning. For work of moderate size allowing a quick speed with a light cut, this lathe was driven by a catgut band or by a leathern strap on the steps of the pulley; large and heavy work required a slower speed to permit a heavier cut, attained by replacing the pulley by a toothed wheel driven by a pinion. For turning still larger diameters, it was necessary to duplicate the arrangement and to employ two wheels and two pinions, producing considerable reduction of velocity and proportionate increase in the power of rotation. The principal combinations of the

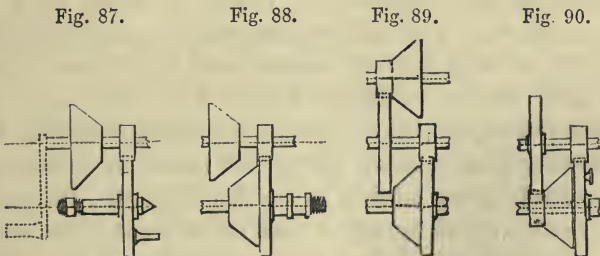

driving gear of the mandrel pulley, together with their derivation, are indicated by figs. 87 to 90; the teeth of the wheels and the grooves in the pulleys are omitted, and for convenience of explanation, the wheels are supposed to be three times the diameter of the pinions.

The dead center lathe fig. 87, which has no mandrel, carries the wheel revolving freely upon its axis in the place of a chuck ; the pinion is attached to a shaft, turned by a winch handle, or more generally by a pulley for a strap. The wheel and pinion turn towards each other or rotate in opposite directions. The same wheel and pinion are applied to a revolving mandrel in fig. 88 ; but for work of small diameter, the band still runs directly to the pulley on the mandrel, and the back shaft not being then required, is for the time placed out of gear, being disengaged by sliding endways until the teeth of the wheel and pinion are out of contact. The band is used " open " when on the mandrel, but runs " crossed " when on the back shaft ; requisite to produce the same direction of motion in the work, on account of the opposite paths of the mandrel and shaft, due to the single pair of toothed wheels.

Two wheels and two pinions for further reduction of velocity and increase of power, are shown by fig. 89 ; the speed of the driving pulley being now reduced and the power multiplied, three times by each pinion or nine times between them. There being now three axes, the direction of the driving pulley is the same as that of the mandrel, so that the strap runs open upon each ; the connection between the wheels is broken as before, by sliding the middle axis endways.

The back gearing, fig. 90, is derived from the last described and is the mode generally employed ; this also requires two wheels and two pinions, but one spindle and one pulley are cancelled by the construction, which is shown on a larger scale by fig. 84. The pinion and pulley on the third spindle in fig. 89, are now *fastened together*, and are allowed to revolve loose upon the mandrel, as if they were one mass upon a stationary shaft, the second spindle remaining exactly as before. The driving band sets the pulley and pinion revolving around the mandrel, giving motion to the back spindle, the pinion of which in turn drives the wheel *fixed* on the front of the mandrel ; and two pinions being used, this arrangement is identical with fig. 89, so far as speed and power are concerned. For turning small diameters, the cone pulley previously loose upon the mandrel is fixed to revolve with it, by means of a sliding bolt or by a screw attachment, which for the time, connects it immovably with the toothed wheel permanently attached at the

front end of the mandrel. The back spindle is disengaged by sliding endways or by being mounted as an eccentric; it is retained in and out of gear by a hinged plate fitting a groove turned in it, or by a pin dropping into a hole through its bearings. In addition to its compactness, fig. 90, allows the band to run always on the same pulley and in the same direction, requiring no change except from fillet to fillet of the cone.

A modification of the same arrangement is sometimes applied through the chuck, but it is only used in the largest lathes. The back of the face plate is provided with a series of internal teeth, and the pinion shaft is sufficiently long, to allow the pinion to engage in this internal wheel. The pinion takes into a somewhat greater number of the teeth, than if worked externally upon a wheel of the same diameter, while the action

Fig. 91.

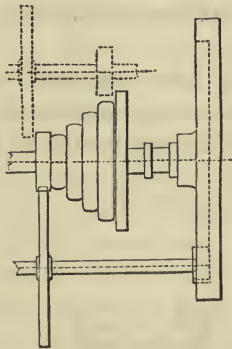

is smoother with less risk of accident; in all other respects the arrangement is much the same as before. There is however a greater difference in the diameters of the wheels and pinions, which in fig. 91, are represented, as say one to three and one to six, and it therefore requires eighteen turns of the pulley for every revolution of the mandrel, decreasing the speed and increasing the power eighteen fold. Lathes to which this gearing arrangement is applied, are also sometimes provided with several changes of wheels, and those shown by the dotted lines are a copy of the dimensions of fig. 90, multiplying nine times. By employing two pairs of wheels on the mandrel and chuck and spindle respectively, say as one to three, one to four, one

to five, and so on, six or eight different combinations may be effected, suitable to varying diameters and other peculiarities in the work. With the power thus applied to the chuck the mandrel is relieved from all torsion, but as the mandrel now *follows* the chuck, there would be some risk of the latter unscrewing; therefore, as the face plate also rarely requires to be removed in the ponderous lathes upon which this method is employed, all liability to such an accident is avoided by fixing the face plates to the mandrel by iron keys or wedges.

Some of the smallest lathes used by the watchmaker and driven by a single horsehair, having been noticed, a few words may be devoted to a lathe of the opposite character, fig. 92, interesting also, as having been constructed by Mr. James Nasmyth, of Patricroft, Manchester, the inventor of the steam hammer; to whose kindness the author is indebted for the following particulars.

The mandrel of this lathe measures ten and a half feet in length, and its cylindrical bearings work in brass collars the one fifteen, and the other ten inches in diameter. End play

Fig. 92.

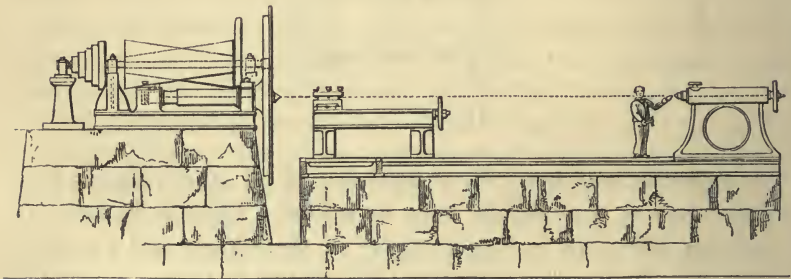

is prevented, by the mandrel being enlarged to twenty inches diameter between the bearings, and by a pair of folding wedges placed in a pocket at the back of the headstock, which serve to advance the hard steel tail pin. The diameter of the face plate is fifteen feet and its weight eleven tons, it is bored out to fit the cylindrical end of the mandrel, and so tightly, as to require forcing on by screw pressure, a single key being sufficient to

retain it. The lathe serves for work of all ordinary forms, and has a break bed, the pit of which will receive wheels twenty-five feet in diameter; while to accommodate long shafts the bed is forty feet in length, and is provided with a popit head five feet high from the surface of the bed and nine feet in length of base, the center point being nine inches in diameter. The slide rest is about ten feet in length, it can be placed either parallel with the axis for turning shafts, or at right angles for surfaces; for the latter purpose the plan of the iron bed is that of a letter **L**, the cross piece being about twelve feet long. The slide rest can also be placed obliquely.

The driving gear is very appropriately contrived, there is one toothed wheel and one pinion on the principle of fig. 40; the pinion working in an internal wheel cast upon the back of the face plate, as in fig. 91. These two are respectively nine inches and thirteen feet in diameter, and of two and three quarters pitch; this considerable difference in diameter producing a reduction of speed of nearly eighteen times, while the absence of wheels and pulley on the mandrel, allows a more massive and rigid form to be given to the headstock. The strap and speed pulleys, comprise a pair of reversed cones placed horizontally at one side, parallel with, but at a small height above the mandrel. The one A. is fixed on the pinion shaft, the other B. upon the axis carrying the driving pulley C. The speed may be varied about threefold before starting the lathe, by changing the position of the driving strap upon the fillets of the driving pulley C.; and again, about seven times when the lathe is revolving, by the traverse of the second strap along the cones A., B. The traverse of this strap is effected by a long guide screw connected with the pinion shaft, so that the revolution of the lathe is accelerated or retarded in accordance with the diameter, hence all portions of the surface being turned always pass the tool at the *same* rate, whatever may be its diameter and whether the tool be proceeding to or from the center of the disc.

The driving pulley C. may be made to run about eight times as fast, as the edge of the work of twenty five feet diameter, which provides ample power for that size. The quickest speed is about twenty times as fast, and therefore in proportion to work one twentieth of that diameter, or that of about fifteen

inches, perhaps the smallest work that would be required in so large a lathe. The steadiness of cut was considerably improved, by an additional source of momentum in the fly wheel D., fixed upon the pinion shaft immediately behind the face plate. The fly wheel measures eight feet in diameter and alone weighs two tons.

The total weight of the lathe without its stone work is 60 tons, 16 cwt., while that of the watch maker's little turn with its centers, previously mentioned, is but $4\frac{1}{2}$ oz. troy; by comparison, every grain in the watch maker's lathe represents 63 lbs. 1 oz. of its huge relative, while the watch pivot of one three hundredths of an inch diameter turned in the former, is but the 90,000th part of the circle of twenty five feet diameter that may be turned in the latter. The individual products of the two lathes also offer an excellent illustration of the wide range covered by the apparatus and the art of the turner.

SECTION IV.—DRIVING AND COUNTERSHAFTS.

In the larger back geared lathes driven by power, the round driving band is replaced by a flat leather or other belt, and the manner in which these driving straps and their pulleys are employed, may be briefly referred to. The power of the strap, which depends upon its wrapping contact, increases directly with its width; the latter therefore is always proportioned to the magnitude of the work to be performed. The leather driving straps, which in most particulars hold their ground against various competing substances, and are most general, when of moderate dimensions are made of one thickness; the larger sizes are of two or more thicknesses of leather, sewn together by seams along their entire length. The ends of the strap which overlap, are punched with a series of holes and are joined by lacing with narrow leather thongs, which latter are indurated and toughened by various processes of manufacture. The joining by lacings, has the advantage, that it enables the belt to be tightened by the extent of the difference between one or more holes; but in addition to the lacing, portions of the driving straps are frequently joined by various forms of metal rivets, useful when a strap requires lengthening or piecing for repairs; sometimes these belts are entirely joined

by rivets or other forms of metal couplers. The driving straps for lathes, range from about one and a half to about eight inches in width, two to three inches being perhaps the average size.

The mandrel pulley has the grooves replaced by a series of quasi-flat fillets, fig. 84, each being turned to a flat arc, so as to be slightly higher in the center of its width, the corresponding speed pulley on the countershaft, and all the driving pulleys being turned in a similar manner. This formation of the edge of the pulley is necessary to neutralize a characteristic of the wrapping contact of the flat band, viz., to run up

Fig. 93.

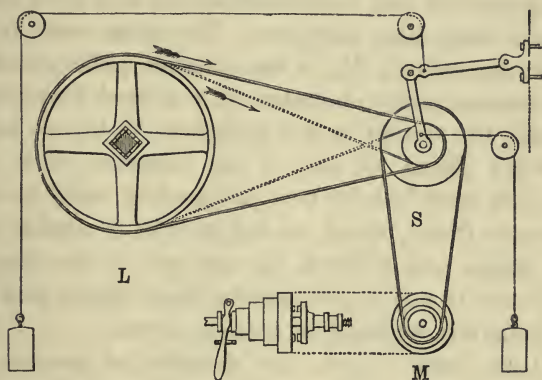

hill. A band wrapped around a cone leads to the larger diameter, and if the rim of the pulley be any larger at one edge than the other, the band in its revolution continues to find its way to that side, and if free to escape runs itself off the pulley. A trifling difference from the cylinder suffices to prevent this accident, and the formation equivalent to a double cone base to base, forces the strap to take the middle of the width of the rim for its seat. The action of the double cone is very visible when the running strap is shifted from one to the other of the fast and loose pulleys, running side by side upon the shaft. The strap, from the draw of the cone or first half of the width, invariably finds its way beyond the center of the pulley on to which it is carried, but this is immediately corrected so soon as it meets with the contrary influence of

the reverse cone, forming the other half; when the strap returns and settles itself under the combined influence, exactly centrally upon the curved edge of the pulley.

The driving shafts and pulleys occupy definite positions; they are generally fixed to or near the ceiling, one driving or "lying" shaft usually running the entire length of the shop. This moves constantly in one direction and at one velocity, and generally communicates the power to several machines, each of which therefore requires means of changing both the velocity and direction of the motion received. The method formerly employed by the millwrights for driving the lathe by power, is explained by the diagram fig. 93; the swing arm contained in the arrangement is very convenient and is still often employed for this and many other purposes. The lying shaft L, carries a large driving wheel; M, is the mandrel pulley, and S, the swing or tension pulley, mounted in a jointed frame attached to the wall; the motion is led from L to M, by two belts, the second being placed on any of the diameters of S, and M. The belts are stretched by two independent weights attached to the tension frame, which are led away by a suitable arrangement of chains and pulleys, to any part of the shop where their presence is not inconvenient; these chains and weights are now generally replaced by tension screws.

With both bands "open," the direction of motion is alike in all three axes, with one "crossed," the direction of the mandrel is reversed. The pulley M, runs either loose or fixed on the mandrel, by one or two studs, placed and retained in or out of action by a gearing fork or lever. This latter contrivance, known as a clutch or catch box, is inconvenient when used for this purpose in the lathe, or in any other machine moving rapidly; as it communicates the whole velocity and power at *once* to a mass previously at rest, causing a blow or jar highly objectionable.

The ordinary modern arrangement is that indicated in plan by fig. 94, but the mandrel pulley M, must be assumed to be vertically beneath C. The driving shaft L, and the mandrel M, remain as before, but the swing arm is replaced by the countershaft C, which runs in fixed bearings attached to the wall or ceiling. The center of the countershaft carries a fixed cone or step pulley, the diameters of which agree with those of

the mandrel pulley; at either end, it carries three pulleys, two loose and one fixed, for the driving straps from L.

The fixed pulley 1, and the two loose pulleys 2 and 3, are drawn of the same diameter as the one wide driving pulley 7, on the shaft L; when therefore the band connects 7 and 1, the two shafts travel with equal velocities and in the same or opposite directions as the band may be open or crossed, and when the band is shifted by the forked strap lever, from the fixed pulley 1, to the loose pulley 2, the latter alone revolves without moving the countershaft. The fixed pulley 4, and the two loose pulleys 5 and 6, are under precisely the same condition with respect to their driving pulley 8, but, they are only of half the diameter of that and of all the other pulleys; 4 therefore drives C, at twice the velocity of the driving shaft.

Two belts are more generally employed with the two sets of pulleys at the same time, the one crossed and the other open; the lathe is driven slowly by the pulleys 1 and 7, when the

Fig. 94.

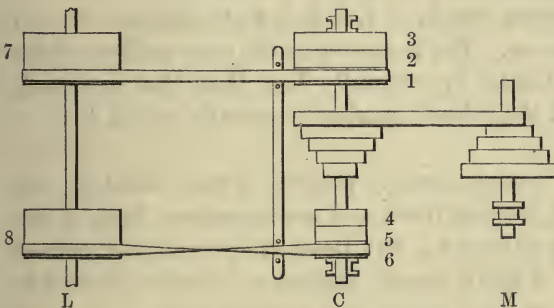
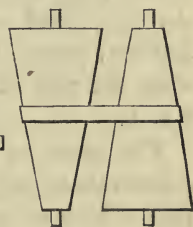

Fig. 95.



tool in the slide rest is traversed in the cutting direction, and the running back or return, is effected at twice the speed by the pulleys 8 and 4, the loose pulleys causing the belts to be alternately active and passive. The two belts are shifted simultaneously by two forks attached to one strap lever, the forks acting on the straps as these run *on* to the countershaft pulleys; when the driving bands run upon pulleys 2 and 5 the countershaft and mandrel are at rest. One loose pulley of the combined width of the two at either end of the countershaft, may replace these with similar results.

To provide for alterations in velocity, the corresponding fillets of the cone pulleys on the mandrel and countershaft are turned in pairs, their respective differences in diameter forming equal quantities; a driving belt of one length serving to connect any pair. The relative differences in the cone pulleys C and M, fig. 94, may be assumed to be as 6 to 18. 9 to 15. 12 to 12. 15 to 9. and 18 to 6; which, when a driving strap from L, runs upon pulleys 7—1, give five velocities. Calling the slowest of these 1, the others would be respectively $1\frac{2}{3}$. 3. 5 and 9 times as fast; but, if the driving strap from L, runs upon pulleys 8—4, each of these velocities would be doubled; so that the entire series of speeds to be derived from the arrangement of the two cone pulleys C and M, without the back gearing, would be 1. $1\frac{2}{3}$. 2. 3. $3\frac{1}{2}$. 5. 6. 9. 10 and 18; that is, the quickest would be eighteen times as fast as the slowest.

The series of speeds thus obtained sustains further variation from the back gearing, by which, for large and heavy turning, each is considerably reduced. Thus, if the result of the combination of the wheels and pinions of the back gearing, be as 10 to 1; the assumed speeds of 1. 2. 3. 5. 9 etc., become $\frac{1}{10}$. $\frac{2}{10}$. $\frac{3}{10}$. $\frac{5}{10}$. $\frac{9}{10}$ and so on. The variation in the cone pulleys of the smaller power lathes is generally less than that assumed, while the rate of their back gearing is usually about 4, 6, or 8 to 1.

The speed or complementary pulleys of the mandrel and countershaft, are derived from, and are a compact form of the pair of long cone pulleys fig. 95; these are very slightly curved in the direction of their length, and are relatively eighteen to six in diameter, at their larger and smaller ends. They are employed in one of Mr. G. Bodmer's numerous ingenious contrivances, patented in 1841. "An apparatus for communicating power to lathes, by which the power and speed can be regulated with exactness." The speed pulleys fig. 95, are now only occasionally used for this purpose, but in like manner to fig. 94, they vary the rate from 1 to 9 or 1 to 18, and, as the strap fits at all points from end to end, they afford all intermediate speeds, or they permit the speed to be continuously reduced or increased, for which purpose they are employed in lathe fig. 92.

The pair of pulleys made as cones are essential to the

manufacture of the intermediate sized works of the potter, and most conveniently supply the varying speeds at which these have to revolve, in order that the larger and smaller diameters of the work raised from the clay by his hands, may attain the requisite and nearly similar surface velocity. The one cone running at a constant speed by power, the band is continually shifted by an assistant to vary the rate, to agree with the portion of the work in progress; or, the band is crossed and passed through an iron loop, a line from the loop is attached to the edge of a wheel, and the one end of a counterpoised lever passing through the axle of the wheel is under the foot of the potter, who can then exactly regulate the speed to his requirements without assistance. The loop carries the strap in the contrary direction along the cone pulleys, so soon as the pressure of the foot is relieved, by a weight and string led over a tension pulley.

The variation of the constant speed of steam power, is differently attained for the production of the smaller works, such for instance as stone ware ink and blacking bottles, in which the difference of diameter occurs only at the neck. These inexpensive objects are produced with surprising rapidity, to attain which it is also requisite that the wheel may be instantly stopped, for the few moments necessary for the removal of the finished bottle, and for the next mass of clay to be thrown upon it by the assistant, and as instantly started at full speed. This, and the variation in speed, are both procured in a very simple manner. A slack leathern band is led around a pulley about the center of the vertical spindle of the throw, from a horizontal driving wheel three or four times its diameter, which revolves at a constant and rapid rate. The feet of the operator rest upon two levers; one of these actuates a break, which bears upon the surface of a third wheel or disc attached to the lower end of the vertical spindle of the throw, and when running with a slack band, the friction reduces the rate of revolution as required, or entirely checks it. With the break relieved, the other lever is used to press forward a tension pulley to tighten the band, to instantly start and to continue to drive the throw, at the full speed of the rapid revolution of the driving wheel; all the pulleys are provided with deep rims to prevent the escape of the band. On the other hand, the largest works of the potter require a

slow speed, his throw being then set in revolution by a hand fly wheel turned by an assistant.

The old and the modern arrangements of shafting and driving gear used by engineers, differ in almost every particular besides those already referred to. The old heavy square shafts, with a slow velocity of from twenty to sixty turns a minute, and large wheels to increase the speed; it may be said, have entirely given place to small turned shafts, usually not exceeding about two inches in diameter, travelling at the rate of from one to two hundred turns per minute; with driving pulleys, generally from about only eight to twenty-five inches in diameter. The light modern shafting at its increased speed, of say one hundred and eighty turns, has only to accomplish in every revolution, about one sixth part of the work of the old slow moving shaft of thirty turns; it also only requires to be one sixth of the strength of the latter, while all the driving gear is made as light as possible to avoid momentum. The wheels and pulleys are bored to fit the circular shafting, to which they are affixed by keys, thus permitting the easy fixing, detachment and interchange of the different portions. A greater advantage, however, lies in the system of fast and loose pulleys to transmit the motion, by which it is gradually communicated, in place of the whole power being suddenly applied to the lathe or machine. When the driving strap slides from the fast to the loose pulley, the refusal of the machine to start operates as a drag; at the first moment the strap slightly slips around the fixed pulley, and it only conveys the entire speed of the driving shaft after a short interval of time, the gradual transmission producing neither shock nor disturbance in any part of the apparatus.

CHAPTER IV.

MODERN FOOT LATHES.

—♦—
INTRODUCTION.

THE distance at which the axis of the lathe mandrel stands above the surface of the bed or bearers, upon which the lathe heads are carried, called the *height of center*, is used as the term to designate the dimensions of all lathes; and this measure being at the same time the radius, it also indicates the possible diameter of the surface, that may be turned in any particular lathe.

Plain foot lathes, vary from about three, to occasionally eight or nine inches in height of center, and in most cases the lathe heads, mandrels, chucks, and other apparatus are made of proportionate dimensions and strength; the bearers and frames, also increase in length about relatively. Lathes of the lesser dimensions, although sufficiently suitable for some few specific purposes, frequently prove inconvenient when applied to the general requirements of turning, from the very limited range of work to which they are adapted; and also, from the almost unavoidable want of stability throughout their various parts. The latter disqualification being made more prominent by reason of the very smallness of the lathe, which renders its use to the utmost extent of its capacity constantly inevitable. The larger of the foot lathes are infrequently met with, generally on account of the great labour required to drive and manipulate the comparatively ponderous apparatus, these therefore, are usually only required and made to meet some exceptional circumstances.

The 5 inch center foot lathe may be considered as the mean in point of size, and also upon examination, as in many respects the most convenient and efficient of the foot lathes for the generality of plain turning, and especially so for the amateur. With very few exceptions the works executed in the foot lathe, of necessity either in their material or con-

struction, consist of forms built up, or made of a more or less number of parts of varying size, joined by fitting or screwing to each other; any one piece of which, rarely exceeds the limits of length or diameter to be obtained in the five inch center lathe.

On a comparison of the working of the five inch, with that of the lathe of four inch center or even less, the friction arising from the increased size of the mandrel and other working parts, is so completely within the limits that are convenient to the operator, that it may be disregarded as of no practical importance; the increase in the power required in driving the first, being often hardly discernible. On the other hand, the proportions of the several parts of the five inch center lathe, are found to be those most completely in accordance with convenient manipulation; while they are at the same time sufficiently large to permit of efficient construction with consequent stability valuable for all classes of turning, together with sufficient capacity in the length and diameter of the work. All of which also, in no way interferes with the production in the same lathe, of the most minute and delicate turning.

Some of the foregoing, might appear as arguments to still further add to the height of center; were it not, that the five inch lathe when correctly proportioned, is also found to be sufficiently large and stable, to permit its height of center to be temporarily increased, for the occasional purposes for which this proves necessary, by other means described in the succeeding chapter. It must also be admitted, that a further increase in the dimensions of the foot lathe and its adjuncts, soon tells in the weight and friction of the working parts and the power required for driving, with proportionate increase of cost, without corresponding advantages.

The correctness and truth of the work produced, depending primarily upon that of the lathe heads and mandrel, these usually receive most careful construction, and should also be of the best materials, to ensure their permanent accuracy. The lathe heads and mandrel, which, it may be permitted to be said, can hardly be too good in quality for all purposes of turning, may then be mounted upon frames constructed either

with a view to economy, or to the highest attainable accuracy ; and the remaining portions of the lathe completed, according to a similar scale and to agree with its ultimate purpose.

It would considerably extend these pages, and it is thought would hardly offer commensurate advantages, to attempt to collect and describe every variety that has been introduced into the form of the modern foot lathe ; for, and in many of which, it is often sufficiently obvious, that there is neither satisfactory reason nor practical advantage. The more usual forms of the plain and other lathe heads therefore, together with those of the frames and other parts of the apparatus, which are referred to in the following pages ; will, it is hoped, be found to afford sufficient types. The lathes described are grouped with a view to a gradually rising efficiency ; from those suitable to plain turning, to those, which still intended for this purpose, are more comprehensive and are also adapted to be the foundation, for the addition of apparatus for special purposes and for ornamental turning. The descriptions of the various parts will also afford an opportunity to lay before the reader, such information upon their use and construction as may appear desirable in this place ; while more extended notices demanded by individual portions, and also some particulars of additional apparatus, in less constant use, but meeting many requirements in plain turning, are collected in the succeeding chapter.

SECTION I.—LATHES WITH PLAIN OR BACK CENTER MANDRELS.

The plain or back center, five inch lathe head, fig. 97, is of cast iron, about nine inches long at the base, the under surface of which is flat, with a central tenon about an inch wide and deep, to fit the interval of the lathe bearers. The head is fixed upon the bearers, by a bolt screwing into the tenon with a washer beneath them. The two apertures in the front and rear of the lathe head, for the reception of the mandrel and back center, are precisely in one line ; with which line, the under surface of the lathe head and the sides of the tenon are parallel. To ensure the correctness of these positions, the two apertures should be bored simultaneously, by a single

cutter bar, carrying two cutters, after the method explained and shown by fig. 514, Vol. II.

The aperture in the front of the lathe head, is permanently filled with a hardened steel ring, called the *collar*, bored and turned out conically from behind and exactly fitting the front cone of the mandrel. The plain cylindrical aperture bored in the back of the lathe head, is fitted with a true steel cylinder, the front end of which is hardened and turned with a hollow center, to receive and support the pointed back end of the mandrel. The cylinder or back center is drawn forward, by means of the short portion of its front end which projects, this, is cut externally with a screw thread, screwing through a detached flat steel ring, attaching to the lathe head, and prevented turning by a pin. When sufficiently advanced, the back

Fig. 96.



Fig. 97.

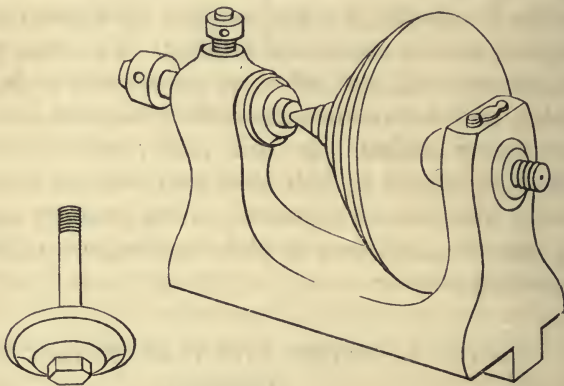

center is fixed by a screw from above, the end of which is prevented doing injury by an interposed piece of brass, bearing upon the plain portion of the cylinder. The back center for the lathe mandrel is sometimes formed as a screw, but this is far less efficient. The plain fitting of the cylinder, in fig. 97, being both independent of its means of advance and exactly true with the mandrel axis, secures the important quality, that the back center always advances in the axial line of the mandrel. Whence, the mandrel is never liable to jam or bind, from bearing more forcibly against one side of the collar than the other; while the wear between the hollow and pointed

center and that between the mandrel and the collar, being impartially distributed around their respective circumferences, tends to the preservation of their forms and delays their deterioration.

The mandrel of fig. 97, is of steel, and fits the collar by the double cone fig. 82, previously described, the back end or point and the cones of the front end are hardened. The pulley by which the mandrel is driven, is of wood, iron, or brass, the metal pulleys being hollow, to avoid unnecessary weight and momentum.

The extreme end of the front cone of the mandrel, slightly projects through the face of the collar, and beyond it, is the nose or external screw to carry the chucks. The diameter of the nose being less than that of the projecting end of the mandrel, the latter has a small width of annular space, which is turned flat, to a true surface, and is known as the *face* of the mandrel. The face of the mandrel is necessary to the correct and continued fitting of the chucks; that is, that they may be removed as frequently as is required during the progress of the work, and when replaced, may again take up the same position, screwing up neither more nor less upon the nose; under which circumstances alone, the work will again run precisely true. This essential quality, is not ensured by the fitting between the external and internal screws of the nose and chuck, also highly necessary, but only by the intimate contact between the face of the mandrel and the face of the chuck; the two being also always screwed up together with moderate and uniform force.

This important subject is further developed with reference to tapping and making the screws in the chucks, by which they attach to the mandrel. But, it may be pointed out here, with respect to the terms employed, that the surfaces of chucks, are generally distinguished, as the front or the back; but, that that portion of the chuck which fits against the face of the mandrel, is always called the *face* of the chuck, although situated on its proper back.

A small vertical hole is pierced through the front of the lathe head and the upper side of the collar, to admit the oil required by the mandrel; and should be fitted with a cover or pin to exclude dust or turnings. The mandrel is usually

supplied with a small quantity of oil, immediately before commencing turning, and also at intervals during the progress of the work; the oil used should be pure animal and *not* vegetable oil, the acids generally present in the latter being very injurious.

The mandrel when working revolves in a thin film of oil, which finds its way between it and the collar; but the revolution, tends both to dry up the oil, and also to force a portion to find its way out at the front of the collar, rendering a small additional supply frequently necessary. Should the mandrel be permitted to work, until the surfaces commence to dry, both rapidly heat, and if this be allowed to continue until they are absolutely without oil, they may adhere to and damage each other. The injury sustained, takes the form of a roughening of the surfaces, and in serious cases, the mandrel and collar are torn and disintegrated, blister-like excrescences appearing on the surfaces of both, and from this cause they sometimes become interlocked and fixed. All such injury in whatever degree is very difficult to recover, bad cases, requiring the reduction of the mandrel and the introduction of a new collar with consequent deterioration of their correct proportions. When the lathe has been for some time out of use, the mandrel may require to be taken out of its bearings, that it and the collar may be cleansed from the hardened oil collected around them. This may generally be effected by rubbing with a rag and fresh oil only, avoiding if possible, the use of any kind of grit.

The axis of the *plain popit* head, fig. 98, is bored out to be in precisely the same line, vertically and horizontally, with that of the mandrel; the under side of the base and the sides of the tenon, by which it takes its adjustment on the bearers, being also in agreement. The holding down bolt, is permanently fixed to the tenon and has a fly nut and washer fig. 103, beneath the bearers. The hole bored through the casting in the plain popit head, is fitted with a cylindrical piece of brass, bored and tapped to receive the pointed center screw; which latter when advanced against the work, is retained in position by a binding screw above, provided with an internal brass washer to prevent injury to its threads. The pointed center screw is advanced by a loose lever, passing through a

transverse hole in the head ; the lever being twisted round in either direction, to advance or withdraw the screw, by the index, or the two first fingers of the right hand, straightened and placed against its shaft. A hollow center is usually left in the head of the screw, that the plain popit head may be used when turned round to stand in the reverse direction, for the support

Fig. 98.

Fig. 99.

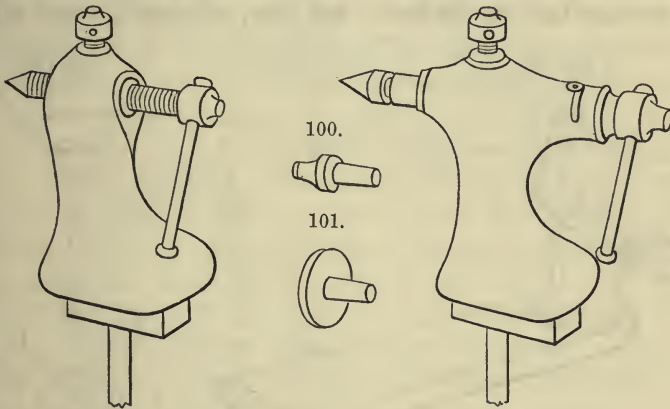

of spindles and other pointed work. A wheel or a winch handle, is often fixed upon the head of the screw, this, is more frequently done with the cylinder popit head. The lever however, as in figs. 98 and 99, is to be preferred in most cases ; it is less obstructive, and with it the fingers are able to more truly appreciate the advance of the point, an advantage of some importance, especially for drilling work revolving on the mandrel, as the extent of the cutting action of the drill can then be more exactly felt and moderated.

The pedestal of the *hand rest* fig. 102, stands upon the surface of the bearers, to which it is fixed by a bolt, fly nut and washer, fig. 103 ; the head of the bolt is of dovetail section and slides freely in an undercut groove in the rest bottom. The cylindrical stem of the *tee*, fits into a vertical socket at the one end, and is retained fixed at the required height and angular position, by a side screw provided with an internal washer to convey the pressure. The tees for the support of the tool, sometimes called "banks," are of iron and usually vary from about two

to six inches in length. The upper part slopes forward, so that the front edge stands beyond the cylindrical stem, it terminates above in a narrow horizontal surface, about a quarter of an inch wide. Two or three tees of different lengths are commonly required, and others with flat tops or of particular forms are occasionally in use.

The simple combination of parts in the hand rest, allows very considerable choice with respect to the position at which the tee may have to be fixed ; and this, constantly varies with

Fig. 102.

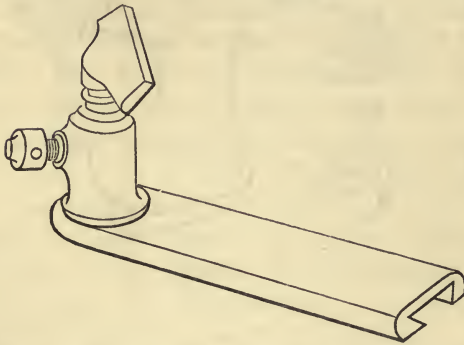

Fig. 103.



the dimensions, form and progress of the work. The holding down bolt, has the range of the length of the bearers, and of the length of the rest bottom, the latter may therefore be fixed at any place or angle upon the bearers; the tees admit of all requisite change of height and angular position, by their cylindrical stem within the socket, and the adjustments being under the control of only two screws are very readily effected.

The lathe heads, may be mounted upon bearers and frames made entirely of wood. The wooden lathe bearers, although employed principally for economical reasons, also have the advantage of being easily constructed, while they are very fairly permanent; hence, they are found in very general use among the professional wood turners. They are usually formed by long parallel pieces of wood, two or three times as deep as they are wide, halved into, or attached by bolts to the wooden uprights.

The five inch center lathe, fig. 104, in which the lathe heads described, are mounted upon bearers made of hardwood, is offered as an example of a lathe fairly adapted to most plain turning; but, it must be admitted on account of the wood bearers and some other points of construction, that it is not

Fig. 104.

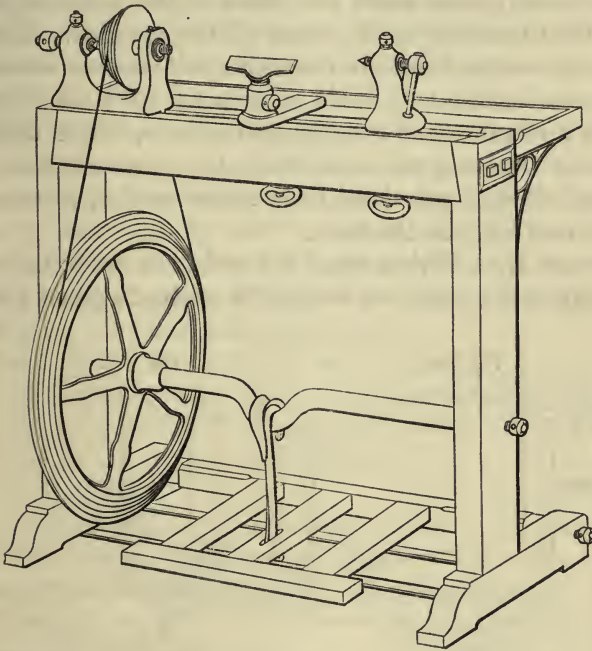

so suitable for the more accurate works in metal, and only to a limited extent for the addition of further apparatus, such as that required for ornamental turning.

The bearers are made of two parallel bars of mahogany or other hardwood, with a parallel space between to fit the tenons of the lathe heads, the width of which is given by two rectangular pieces of boxwood, fig. 105, inlaid vertically in the uprights. The sloping ends of the bearers are received in recesses in the uprights, sloping inwards, and are attached in this species of dovetail joint by bolts, screwing into nuts inlaid in them: the construction permitting the bearers to be detached and always replaced with precision at their original distance. In replacing the bearers after the frame has been

taken to pieces for packing or any other purpose; the bolts are first partially screwed up, the bearers are then driven into close contact with the boxwood blocks and the bottom of the recesses, by a few blows of a hammer, a flat piece of wood being interposed to receive the blows to avoid injury to the surfaces, after which the bolts are completely screwed up. Washers are placed under the heads of the bolts, to prevent them from penetrating the wood of the uprights. The uprights are mortised into the transverse feet, and are secured by bolts screwing into nuts inlaid in them fig. 106; the bolts also passing through one of two iron bottom bars, which assist the bearers in retaining the uprights in the perpendicular. The feet are hollowed out along their under surface, to cause the ends to rest fairly on the floor.

The cast iron driving wheel is bored to fit upon the turned extremity of the crank, on which it is retained against a flange,

Fig. 105.

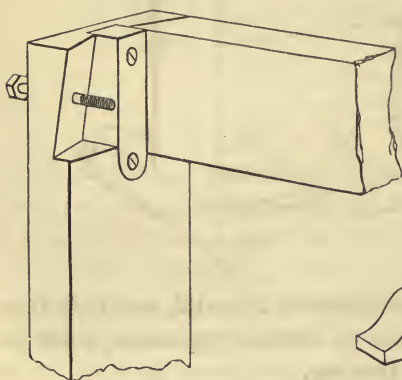
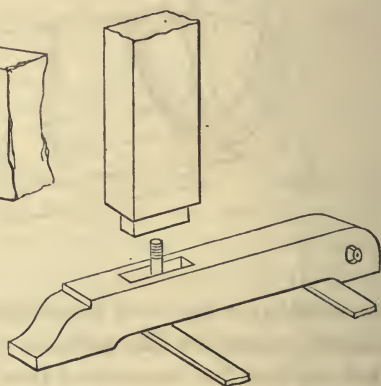

Fig. 106.



and prevented from moving round upon the crank in the manner previously described. The wheel has a single bevil, turned with five speed grooves, for use with the five grooves of the wood mandrel pulley. The crank is of round iron, steeled and hardened at the extremities, which revolve upon pointed hardened steel centers inserted exactly opposite each other in the uprights; the center on the left, is formed with a square tang, securely fixed in the upright, that on the right, is made as a screw and passes through its upright to give adjustment.

The treadle is formed of three transverse rails, mortised into the wooden foot board and axis; steeled hollow centers with square tangs, being fitted and driven in a true line into the ends of the latter, which are strengthened and prevented from splitting by strong iron rings or ferrules. The treadle works upon centers similar to those for the crank and in the same positions, fitted into the ends of the feet. The crank hook is of iron, steeled and hardened within the hook, the lower end is pierced with a hole and works on a steel pin passing through the center rail of the treadle. The hook is of sufficient length, to allow the treadle to hang just clear of the floor and iron bottom bars. It is essential that all three pairs of centers, should stand at right angles to their supports, and exactly opposite to each other in both the vertical and horizontal directions; otherwise, smooth and regular action in the crank and treadle is not obtained, and the various centers rapidly deteriorate and grind each other away.

The frame is completed by the backboard fig. 107, a shelf grooved into the back bearer and supported by light iron

Fig. 107.



brackets. It is surrounded by a rim to prevent the tools from rolling off, and is pierced by a hole for the passage of the lathe band; it also carries a removable board, upon which the various chucks are inlaid or otherwise secured.

It is not proposed to lay down an exact list of chucks that may be required for fig. 104, or for the following lathes referred to, such particulars could hardly be satisfactory and would afford little guidance; for although certain chucks are almost invariably necessary, yet the particular varieties adopted, may be considerably influenced by the purposes to

which the lathe is to be applied. The various chucks made of metal, of wood, and of the two in combination, and their distinctive purposes and peculiarities, are described at length in a later chapter; it may therefore be sufficient to say, that the metal chucks required in plain turning usually vary with the scope of the lathe, from about twelve to twenty-four in number, and they are always found to include a larger proportion and some variety of sizes of the more simple kinds.

The lathe fig. 104, may be made somewhat more appropriate for the addition of other apparatus for turning, by substituting the iron bearers fig. 109, for those of hardwood. The wood uprights however may be advisedly retained, wood frames having some advantages peculiar to themselves, among them, in being less susceptible to vibration than those of iron, which

Fig. 108.

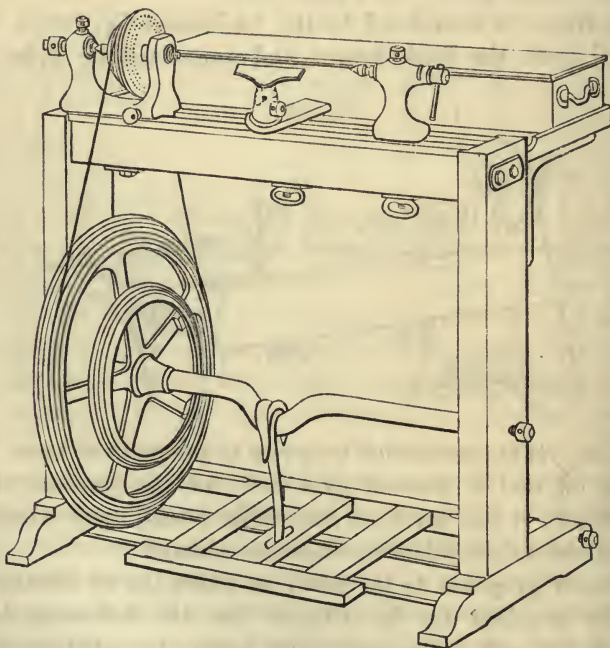

is found to render the turning of smooth plain surfaces somewhat easier. Sometimes it is desirable that the frame should

also be entirely of iron, when the lathe takes the form of that shown by fig. 110, or of some analogous pattern; the upright and foot being usually in one solid casting.

The lathe with single wood frame fig. 108, resembles that lately described, but is provided with iron bearers; a double bevil wheel, giving a slower speed; a cylinder popit head with leading screw; and a division plate and index; the description and application of the last are deferred to the following chapter. The chucks and loose implements are carried in a long case, standing upon the back board.

The cast iron bearers for this and similar lathes, are usually first planed flat and straight in the planing machine, they are then mounted between centers and the external ends are turned square to their length. They should be subsequently corrected

Fig. 109.

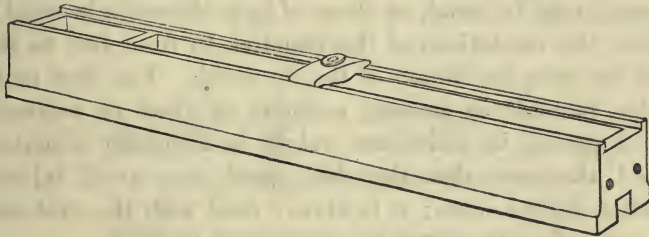

upon their upper faces and upon their internal and external sides, with the file and scraper, with which tools, under the guidance of the straight edge and planometer, they are finished to any required degree of accuracy.

The iron bearers shown detached and reversed, fig. 109, are connected at the extremities and in front of the lathe head, by transverse pieces cast in the solid; the division across in front of the lathe head adds to their strength, and in reducing the length of their opening diminishes torsion. The washers for the bolts of the lathe heads, are oblong and rebated to loosely fit between the planed lower edges. The ends of the lathe bearers are received in flat recesses upon the inner sides of the uprights, with which they are brought into firm contact, by bolts screwing into the solid metal; in fixing them in their position, the bolts are screwed up equally and without an unnecessary degree of force, otherwise they are capable of exerting a prejudicial effect, which may be referred to.

Too great, or an unequal strain by the end bolts, is sometimes found to distort the sides of iron bearers of correct proportions and strength; causing them to become slightly bowed, usually inwards, about the center of their open length. Want of truth, or a temporary disagreement between the true ends of the bearers and the recesses in the uprights, which may sometimes arise accidentally when the bolts are screwed up, will produce the same effect. The distortion is usually detected on sliding the popit head along the bearers, when instead of its tenon fitting the interval equally from end to end, it will with difficulty pass, if it be not altogether arrested somewhere about the center. Slightly slackening the bolts usually permits the bearers to return to their original truth.

The second bevil or slow motion on the fly wheel of fig. 108, is employed to reduce the speed of the lathe, requisite in turning works in metal, or those of large diameter in wood; it reduces the revolutions of the mandrel, to from two to three turns for every revolution of the fly wheel. The slow motion is also valuable in turning portions of arms or awkwardly shaped pieces, in which the weight is unequally distributed around the axis, that the slow speed may avoid injurious vibration in the work; it is always used with the oval chuck and some other apparatus for ornamental turning.

The lathe head and hand rest of fig. 108, are similar, but the popit head of this, and the following lathes, differ in construction from those already described. The *cylinder popit head*, is met with in more than one shape, but all patterns, agree in possessing a cylinder advancing through a plain hole; the advantages derived, referred to in the back center of the lathe head, are sufficiently obvious. In the pattern shown by fig. 99, the hole bored through the casting and adjusted to exactly agree with the mandrel axis, is fitted with a plain steel cylinder which slides within it, this, is also bored throughout its length; it is prevented turning round, by a pin fixed in the casting which enters a longitudinal groove or key way cut in the under side of the cylinder. A short portion, at the back extremity of the hole bored through the cylinder, is tapped for the reception of the leading screw, which extends within it; the screw turning, but being retained in one place by a steel bridle, fastened in a transverse mortise in the casting, and

entering a circular groove turned in the shaft near the head of the screw. Turning the screw in the one or the other direction, causes the cylinder to slide forwards or to retire, and when adjusted for work, the latter is fixed by a binding screw from above, which is provided with a countersunk brass washer for the prevention of injury. The projecting front end of the cylinder has a conical fitting, by which it carries separate hollow and pointed centers and the *boring flange*, fig. 101. The last is an iron plate or surface, about two to three inches in diameter, and at right angles to its stem, the plate has a shallow recess at the center to avoid injury to the point of the drill.

The cylinder popit head affords considerably improved accuracy for the support of the work in turning, and also in boring all work revolving on the mandrel; the advance of

Fig. 110.

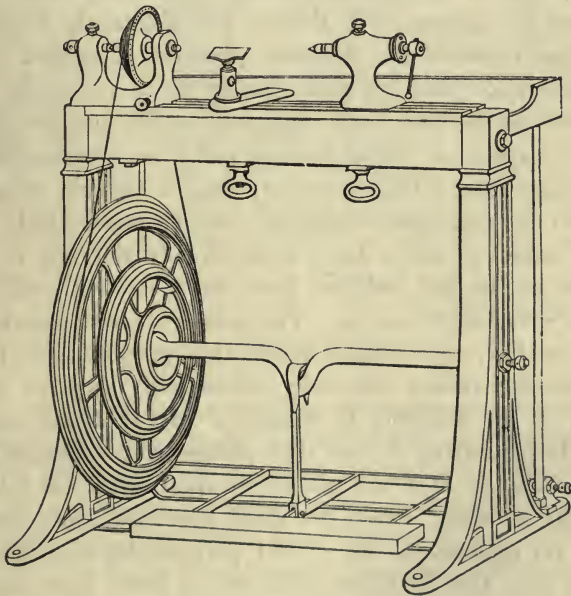

the center point, itself quiescent, acquiring all the truth of the sliding cylinder and therefore supporting the end of the drill in the true line of the mandrel axis. In boring with the flange, the drill revolves in a chuck upon the mandrel, the

work being pressed against the flange and advanced to the drill by the screw of the popit head, and with ordinary care, it cannot fail to be pierced at right angles.

The lathe fig. 110, is given as an illustration of a frame entirely of iron, with the exception of the back board and the foot board of the treadle, which are of wood; the uprights and feet are each formed in one casting. The mandrel pulley is of iron, with or without brass division plate, and there are various minor unimportant changes, incidental to the alteration from the wood to the iron frame, but, from the descriptions already given, the precise details do not appear to merit further notice.

SECTION II.—LATHES WITH TRAVERSING OR SCREW CUTTING MANDRELS.

External and internal screws, more generally of short length, but of all dimensions as to length, diameter, and fineness or coarseness of thread, are constantly required for attaching together the different portions of turned work, in all materials. Striking and chasing these screws by manual dexterity on the back center mandrel, in the manner described in the chapter on screw cutting, is by no means difficult in most cases after a little practice; but, as failures occasionally produce serious inconvenience, various mechanical contrivances, some of which have been already referred to in this and in the second volume, have been devised and used to ensure invariable success. The modern screw mandrel lathe head fig. 112, conveniently fulfils this purpose, and is desirable for the turner who only occasionally requires to cut a screw, or is deficient in practice. It is found extremely valuable in cutting screws that present any difficulty in their dimensions, or that are required upon work of intractable material, in which cases, the most practised hand frequently needs its assistance. It should perhaps be mentioned, that screws may also be struck and cut by hand upon the screw mandrel in the ordinary manner, when that is desired.

The casting of the lathe head fig. 112, is of about the same dimensions as that of a corresponding plain or back center lathe head, but the mandrel is sufficiently longer to project through it at the back. The mandrel is of steel and

is sometimes bored throughout its entire length, convenient among other reasons, for the admission of long wires or for turning very slender rods which may be partially contained within it. It is hardened at both bearings, which revolve and traverse in hardened steel cylindrical collars, fig. 83, the fore part of the front cylindrical collar being conical, the cone standing the reverse way to those for the back center mandrel.

When employed for plain turning, the cones of the mandrel and front collar are retained in contact by a steel cap, fitting upon the back end of the former and bearing against the outer surface of the back collar. The cap, which may be con-

Fig. 111.



Fig. 112.

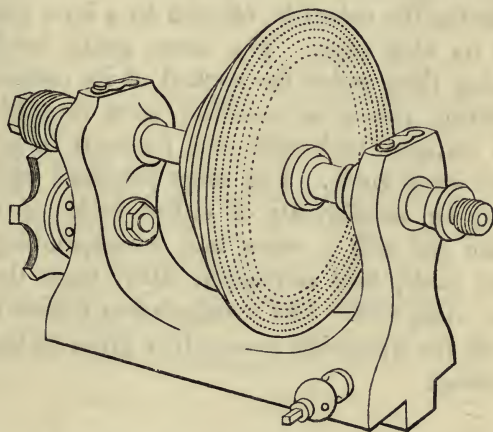

sidered as an elongated washer, is prevented turning round by either one or two studs, and is retained in its place by the head of a screw, which screws into the end of the mandrel. The cap is removed for screw cutting, when the mandrel has free endlong traverse; it is then replaced by one of the screw guides, which also is prevented from moving by the studs formed on the end of the mandrel, which enter corresponding apertures in the cap and guides. One of the studs should be marked, as also one aperture in the cap and in every guide, that they may be correctly placed together; the guide in use, like the cap, is fastened in its place by the screw in the end of

the mandrel. The screw guides consist of strong steel cylinders, cut externally with different accurate screw threads; they engage in the brass conducting piece B., shown detached fig. 111.* The conducting apparatus consists of a brass ring, about one-third the width of the guides in thickness, its outer edge formed by segments of circles, cut with screw threads matching the guides; the ring is mounted and turns round upon the shaded circular piece B., to place any segment uppermost. The shaded circular piece, which is of greater thickness than the segmental ring, is mounted eccentrically upon a pivot attached to the back of the lathe head. The conducting piece therefore can be moved round by the fingers, to place the requisite segment at the top and beneath the guide on the mandrel, and these two are then brought into contact, by turning the eccentric, effected by a lever placed in holes bored in its wide edge. The screw guide fixed on the mandrel, being then under the control of its counterpart on the conducting piece, the mandrel upon revolution, is constrained to traverse backwards and forwards in a path the copy of the screw guide. The screw produced upon the work, which may be indifferently of either large or small diameter, is then cut with a screw tool corresponding to the thread of the guide, held *stationary*, either upon the hand rest, or in the slide rest. The manipulation followed in cutting screws with the traversing mandrel, is given in the chapter on screw cutting.

The screw mandrel lathe head may be mounted upon any frame similar to those already described; but the five inch center, screw mandrel lathe, fig. 113, is given as an example of the double wood frame, and also as the lathe that some experience has shown to offer most advantages, for general plain turning for the amateur and for development for ornamental turning. Most portions of this lathe, will be already familiar to the reader of the preceding pages.

* The screw guides ordinarily made for H. & Co.'s screw mandrel lathes, are numbered 1 to 6, their threads correspond in like order, to those numbered 3. 4. 5. 6. 8. 10 of the table page 673, Vol. II.; these are generally found to suffice, but the number may be extended if required.

The mandrel pulley of fig. 113, which has been used as an example of necessary, careful construction, in the chapter on metal turning, is of brass and is hollow to avoid weight and momentum ; it is affixed about the center of the length of the mandrel, held against a slight shoulder turned on the latter, by

Fig. 113.

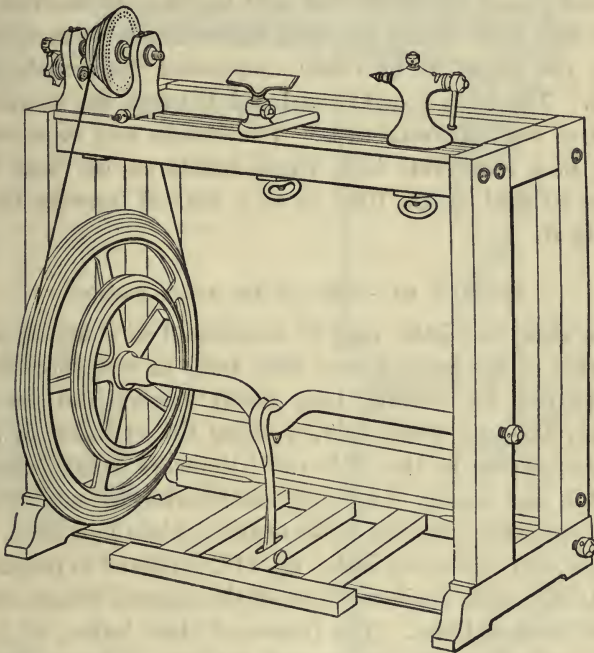

a nut and washer behind, and is retained in position by a steady pin. The face of the pulley forms the division plate, and carries six circles of equidistant holes of the numbers 360. 192. 144. 120. 112. & 96, and an adjusting index is attached to the base of the lathe head. The application of these, and that of various other forms of the index, are given in the succeeding chapter.

It has been mentioned that the wood frame, from being less susceptible to vibration than that of iron, rather facilitates the production of smooth and finished turning ; in addition, it so considerably deadens sound in working, as to be generally preferable for lathes intended for use in the house. The double wood frame, very usually made of mahogany, is still

better in both these particulars, its increased stability causing a consequent further reduction of vibration. Two additional uprights are mortised into the feet, and are connected above by pieces parallel with the latter, forming a substantial framework for the sides of the lathe frame; these sides are joined by strong rails at the back parallel with the bearers. The different pieces are fitted and held together by mortise joints and bolts, with heads in brass countersunk washers, which allows the frame to be readily separated, tightened, or adjusted. The back board is enclosed between the bearers and the three top horizontal rails. The chucks may be contained, either in a removable box, which stands on the back board, similar to that in fig. 108; or in a nest of drawers fitted in beneath it.

SECTION III.—THE SLIDE FOOT LATHE.

The slide foot lathe may be considered as generally a close reduction of the larger power slide lathe in workshop use. It is employed for cutting long metal screws and for plain turning, the tool being carried along the cylinder in a continuous traverse by the slide rest; the work being principally of metal, and usually of a longer and heavier character than can be conveniently executed in the ordinary plain foot lathe. The 6 inch center, slide foot lathe, fig. 114, is offered in illustration, and also to assist the description of the general details common to this class of lathe. The frames of slide lathes, as in this figure, are generally constructed entirely of iron; but very similar lathes, which also are sometimes provided with more elaborate appliances, are occasionally mounted on the double wood frames previously alluded to.

The mandrel of fig. 114, is put in from the front, after the manner of figs. 85 and 86; the fitting in the front collar is that of the double cone, the obtuse cone in front. The mandrel is drawn up into bearing by a detached steel collar fitting upon its back end, which is brought into contact with the outer face of the back collar of the lathe head and secured, by a double nut screwing on the mandrel. The extremity of the mandrel, beyond the double nut, is keyed and fitted for the reception of the change wheels.

The mandrel pulley and the back gearing for the slow

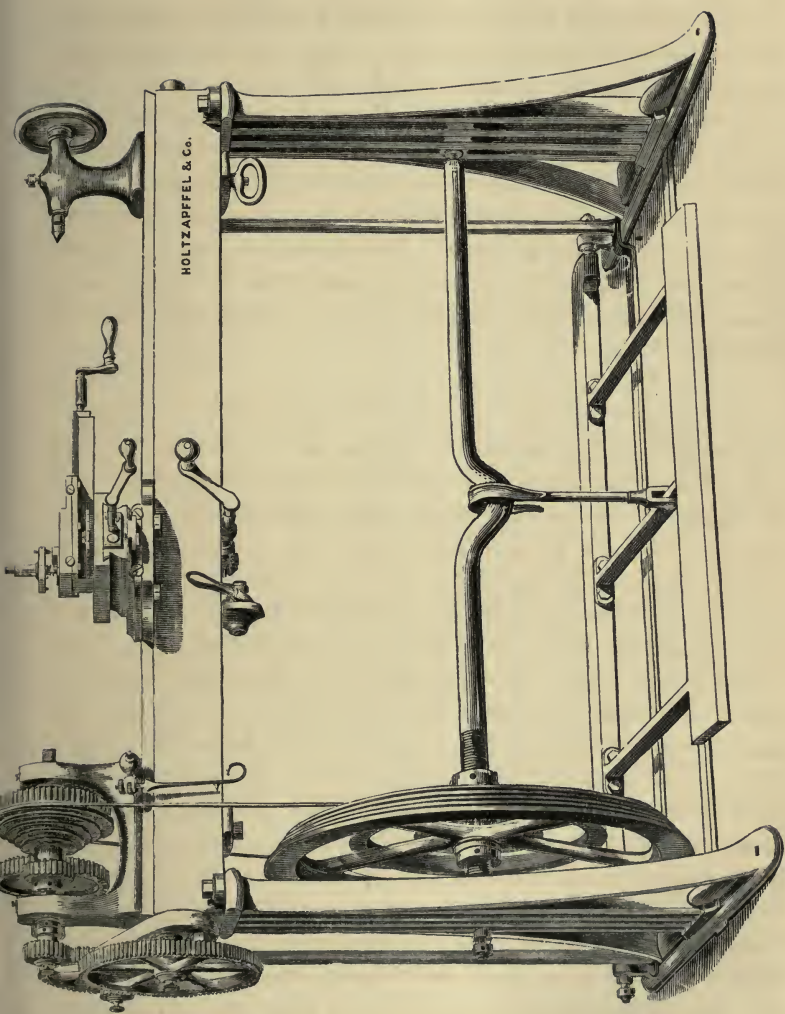

Fig. 114.

motion, are of the form indicated by fig 90, and reduce the speed of the mandrel, about six times, compared with that of the pulley. The large toothed wheel is fixed to the mandrel in front, the pulley for the band and the pinion behind it, are fixed together and revolve freely upon the mandrel; the corresponding wheel and pinion on the back shaft, are both attached to a hollow spindle, revolving upon the central portion of the back shaft, which does not itself revolve but is mounted eccentrically by its ends; a compact arrangement, to place the wheels of the back gearing in and out of action without endlong motion. For driving the mandrel at quick speeds, the pulley is fixed against the front wheel by a nut and washer on the mandrel behind the pinion. The division plate is attached to the face of the front wheel and an adjusting index is fixed to the base of the lathe head. The cylinder popit head is constructed in the same manner as that already described, and the lathe should be provided with a hand rest and tees, not shown, for many small purposes of turning, to which the slide rest does not conveniently apply.

An elegant arrangement to obtain slow motion in the mandrel, differing from any hitherto described, is afforded by *internal gearing*, all the wheels being contained within the pulley itself. The internal geared pulley is sometimes applied to fig. 114, and occasionally to smaller foot lathes, for which latter however the slow motion on the fly wheel is usually found to suffice. The compactness of the internal gearing and the safety to the operator, are its recommendations over the ordinary form.

The pulley is divided into three distinct parts, carrying the wheels in the manner indicated by figs. 115, 116, in which the three parts are shown in section, separated, with the wheels shaded. The face of the pulley or back of the division plate, the first part, is fixed to the mandrel and revolves with it; it is hollowed behind, and the internal edge is cut as an annular wheel, say of 72 teeth. The cone or grooved portion of the pulley is the third part, this slips freely round upon the mandrel, and carries with it, attached to the front end of its socket, a wheel say of 18 teeth, or one quarter of the number

contained in the annular wheel. The second part is a circular plate situated between these two, carrying two wheels, whose sole purpose is to convey the motion by making the connection between the 18 and 72 wheels. This central portion of the pulley does not revolve when the slow motion is in action, but is held at rest by a steel tail piece, fig. 117, temporarily affixed to its edge in a dovetailed fitting, and fastened by a thumb screw; the tail piece being then attached against the base of the lathe head by a removeable steel button fig. 118.

The revolution of the 18 wheel, carried round by the cone part of the pulley which slips around the mandrel, is conveyed

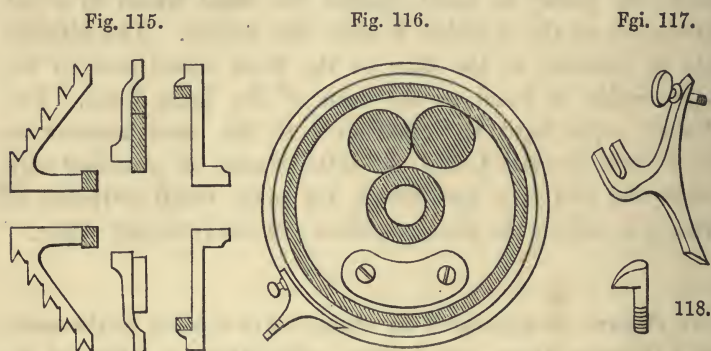

through the two wheels revolving upon the stationary central portion, and communicated to the annular wheel upon the first portion, which, being fixed to the mandrel, carries that round once to every four revolutions of the pulley. A metal counterpoise is screwed upon the plate, opposite the connecting wheels, fig. 116, to preserve equality in the momentum of the pulley, when the slow motion is not in action. For quick speeds, the tail piece, to prevent the revolution of the central plate, being removed, the three parts of the pulley all revolve together, being placed in close contact by the pressure of a screw and nut upon the mandrel behind; slightly slackening this nut, again permits the mutual action of the three parts of the internal geared pulley.

The fly wheel of fig. 114, has three bevils or sets of speed grooves, and is mounted with a power of traverse on the crank,

to place any of its grooves beneath any of the grooves on the pulley. About twelve inches of the cylindrical end of the crank shaft is cut with a shallow square threaded screw, and the fly wheel, is bored out with a plain hole to fit upon it; the wheel is traversed by two nuts, one on either side, and is fixed when brought into position by their close contact, and clamped by a third nut against that on the face, to prevent displacement. The back or axis of the treadle is of wrought iron, wide and heavy; the steel centers upon which it works being welded in the solid, but placed in advance of its front edge, so as to cause the weight of the back to partially counterbalance the front of the treadle. The bearers are of the section fig. 76, to allow internal space for the main screw and clutch box without unnecessary width upon their surface, the external, angular planed grooves, serving to guide the traverse of the saddle carrying the slide rest; the bearers are fixed by four vertical bolts to the cast iron uprights.

The main screw traversing the saddle, in this case is of four threads to the inch, the thread being of truncated angular section; it is fixed inside close against the front of the bearers, the cylindrical ends projecting through them at either end. The screw is placed in from the left and is prevented from endlong motion by a collar, turned upon it in the solid, which is retained in external contact with the left hand end of the bearers, by a screw and double nut at the opposite end; the nuts being only sufficiently screwed up, to avoid straining or stretching the screw. The left hand extremity of the main screw, is keyed and fitted for the reception of the change wheels, and it also passes through the central hole of a radial arm, in which are two long parallel slots for the arbors, to carry the other change wheels, to connect that on the mandrel with that on the screw. The radial arm circulates around the end of the main screw, to vary its radial position on the latter, that it may be fixed higher or lower as required, to accommodate the length of the particular train of wheels employed. It is fixed by a bolt, passing through a circular mortise and screwing into the end of the lathe bearers. Illustrations of some other varieties of form and arrangement of the radial arm, have been given pages 623. 624. Vol. II.

The main screw of the slide lathe is connected with the

saddle to traverse the slide rest, by some form of clutch box ; the particular arrangement adopted for fig. 114, is explained by the following diagram. The working parts, consist of two gunmetal jaws, somewhat resembling the shape of an ordinary pair of carpenter's pincers, mounted upon the same center A. ; their inner surfaces are cut with an internal thread, a counterpart of that on the main screw S. The reverse ends of the

Fig. 119.

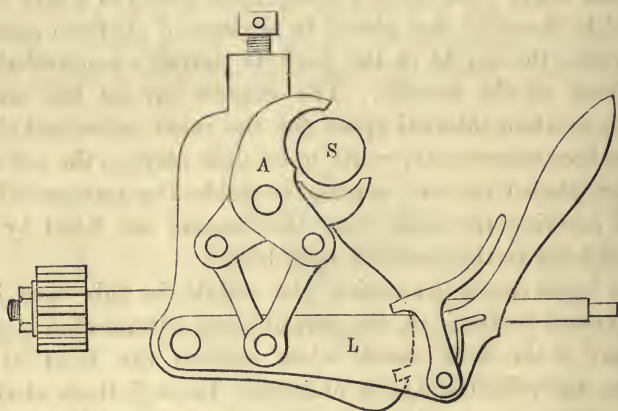

jaws are connected by steel links, also mounted upon one center, upon the lower end of the lever L. On depressing the lever, the gunmetal jaws embrace, and exactly fit the screw for about three quarters of its circumference, exerting an equal pressure on both sides above and below. Raising the lever to the position shown in the diagram, opens the jaws clear of the screw and instantly arrests the traverse of the slide rest. The lever L. also carries a spring detent, arranged to detain it in either of the two positions, and it is bent upwards that it may not inconveniently project in front of the bearers.

The working parts of this clutch box are contained within an iron frame, the end of which is indicated in fig. 119, and this frame terminates above in a longitudinal tenon, which passes upwards between the bearers and is bolted to the under side of the saddle. The saddle plate lies transversely and in contact with the face of the bearers, its upper surface being appropriately formed to carry the slide rest ; which latter is

described in the succeeding chapter. The length of the saddle exceeds the width of the bearers, and two adjustable guide plates are bolted to the under side of its overhanging surface ; these fit against the external grooves in the bearers and retain the saddle exactly at right angles. The length of the guide plates, is about twice that of the width of the saddle, so as to provide an ample guiding surface without increasing the width of the latter, which would shorten the traverse of the lathe.

The lower side of the frame of the clutch box also carries a horizontal spindle, having a pinion working in an inverted rack bolted outside the back of the bearers ; the spindle being turned by a winch handle in front. At the termination of every cut, the clutch is disengaged, and the slow traverse given by the screw, necessary to the due cutting action of the tool in plain turning or screw cutting, is exchanged, when replacing the tool in position for recommencing the cut, for the quick return traverse given by the rack and pinion.

The combinations or settings of the change wheels employed with the slide foot lathe fig. 114, will be found in the fourth section of the succeeding chapter ; in which, the various forms of the apparatus for producing different screw threads from one screw, which serves as a guide or copy, are further considered.

CHAPTER V.

APPARATUS ADDED TO THE LATHE FOR SPECIFIC PURPOSES.

SECTION I.—THE DIVISION PLATE AND INDEX. SCRIBING TOOLS.

THE *division plate*, is a contrivance in general use for graduating the surfaces of work into any number of equal parts. On the lathe it is used among other purposes in plain turning, for setting out equidistant holes, sometimes for the insertion of other portions, as for the spokes of a wheel; for inlaying, and for attaching ornamental projections. For marking the terminal lines upon cylinders or surfaces, previously to cutting or filing them into squares, hexagons, or other shapes for bolt heads, nuts or pedestals; for graduating the edges of works; for cutting the teeth of wheels; and also for the purposes of ornamental turning.

The division plate is generally made either as a wide metal ring attached to the face of the mandrel pulley, or as a circular plate entirely covering it, and in either form it is accurately drilled with several concentric circles of equidistant holes. The numbers forming the circles, are selected from those affording the largest variety of divisions, and for the lathe, usually include 96, 112, 144 and 360.

The *index*, is a steel spring or rod terminating in a point which is inserted in any required series of holes, in any of the circles of the division plate, to retain the mandrel for the time, *at rest, in certain relative positions*. For example, to divide the work into 12 parts; the point of the index is placed successively in the holes 8. 16. 24. 32. etc. of the 96 circle, or in 12. 24. 36. 48. etc. of the 144 circle, the respective divisions of those circles by 12; and, while the mandrel is arrested at these points, the work is marked or cut into with appropriate tools.

The *plain index* is usually made as fig. 120. The steel spring carries a point above, at right angles, at about the level

of the lathe mandrel, and has a round pin below which fits a transverse hole in a plain metal ball; the latter is sometimes screwed into the side of the lathe bearers, but it is more appropriately placed when fixed to the base of the lathe head. The index is more convenient when the upper end of the spring is prolonged as a hook for the forefinger, figs. 122. 123; while the ball should be provided with a fixing screw, as in figs. 121. and 123, to prevent the spring acquiring any lateral motion, to

Fig. 120.

Fig. 121.

Fig. 122.

Fig. 123.

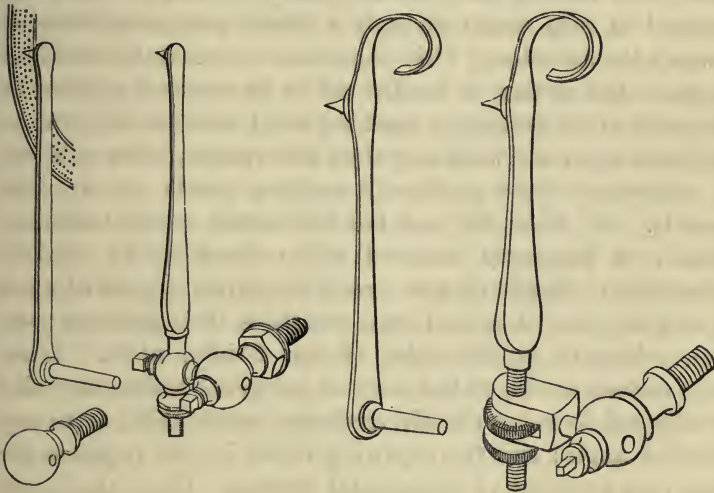

retain the point opposite the circle of holes in use. Sometimes the index spring has a square or triangular stem or slide beneath, in the direction of its length, with a transverse binding screw. This stem is also sometimes continued below, cut upon its edges as a screw and provided with a nut, fig. 121.

The stem of the *adjusting index*, fig. 123, passes through the two sides of a fork, and is provided with two nuts with milled edges, one within and the other beneath the fork. The upper nut which gives the motion, is graduated upon the face or edge into 10. 20. or more equal parts, to ascertain the amount of vertical traverse, and for interpolation, which will be described; the lower nut being for fixing. The vertical height of the adjusting index is readily altered by the fingers; the lower nut is first slackened, the index is then raised or

lowered by turning the upper nut, and is refixed by screwing up the lower nut into contact with the fork.

The power of vertical adjustment in the index is necessary for many purposes of dividing in the lathe; among others, that the point may agree with any fixed starting place on the division plate, when it may be also necessary to make the first cut or division at any particular spot upon the work. Increasing or shortening the length of the index by its screw adjustment, *while*, both the transverse pin remains in the ball, and also the point in a hole of the division plate; obviously causes the mandrel to turn round through a small space, away from or towards the operator. This expedient is constantly employed to place the surface to be divided in its required relation to the point of the cutting or marking tool; and the divisions to be placed upon the work may thus be arranged, so as to bisect or otherwise divide previously existing points or divisions upon it. Or, when the work has been either accidentally misplaced, or purposely removed and rechucked; by slightly shortening or lengthening the index, the divisions marked upon it, may be placed a second time exactly in their previous position, relatively to the holes of the division plate. Lines upon surface works, or the sides of polygonal solids, may also be adjusted to stand exactly vertically, horizontally, or to any required angle; and the adjusting index is also requisite for numerous purposes of ornamental turning. Upon the larger power lathes the index is frequently carried by one, or two brackets, bolted to the side of the bearers, as in fig. 124. This index is also provided with a screw and nut below for varying its length, it is retained opposite the circle of the division plate in use, by a screw passing through the upper bracket, fixed by a nut.

In using the apparatus or *taking the divisions*; the driving band is removed, and the index point is placed in the terminal number of the circle in use, which in practice, is generally possible. The open left hand is laid around the top of the pulley, to turn the mandrel gently towards or sometimes away from the operator, while the point of the index is at the same time withdrawn, just clear of the holes, by the thumb and forefinger of the right hand, and is then dropped into the hole at the required advance. Placing the point in a wrong hole or

number from want of care, may be prevented by making the point count the holes as it passes over them. Thus, if the number of holes to be taken every time be four, the operator withdraws the point, and as he passes over the four holes, makes a slight motion with it towards each, and if he half intended to place the point in each hole; and, as he does so, mentally counts or checks off one, two, three, four, finally dropping the point into the fourth hole. The slight motion thus impressed on the point by the right hand and the independent counting, fairly check each other, and usually prevent the index travelling to a hole short of, or beyond its destination.

The circles of the division plate are also usually marked with figures numbering them at regular intervals, to assist the eye in passing from hole to hole. Thus in the division plate of lathe fig. 113; the 360 circle is numbered with a figure at every 15 holes, reading 15. 30. 45. etc.; the 112 circle at every 7 holes; the 192. 144. and 96. circles, at every 6 holes, and the 120 circle at every 5 holes. In addition to the figures, the 360 circle has a slight mark engraved at the edge of every fifth hole; and the 192 circle has a similar mark on the outer circumference at every third hole, and on the inner, at every fourth hole, for a special purpose that will hereafter be explained.

COUNTING INDEX.

Various mechanical arrangements, and occasionally rather complicated automatic apparatus, have been attempted or employed to replace the index; with the view of diminishing or entirely avoiding, the risk of errors in using the division plate. *The counting index* fig. 125, is one of the more simple forms, and is sufficiently effective. It has two distinct springs, the two points of which are used at the same time, inserted in the same circle of holes, one above the other.

The front index is very similar to those already described, it has a triangular slide and screw below for its vertical adjustment, and a transverse binding screw to the ball. The second or back index, is mounted directly behind the first, and works somewhat like a hinge at its lower end upon the pin, by which the entire apparatus is carried in the usual manner, in the brass ball attached to the lathe head. The spring of the

back index is made in two pieces, the upper, *a*, sliding vertically upon the lower, *b*. The lower half, is provided with two rectangular, steel sliding clamps, which surround both halves of the spring and are adjustable to, and may be

Fig. 124.

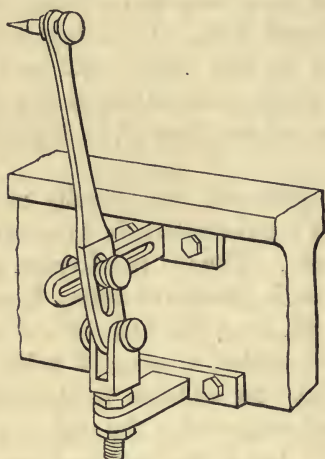
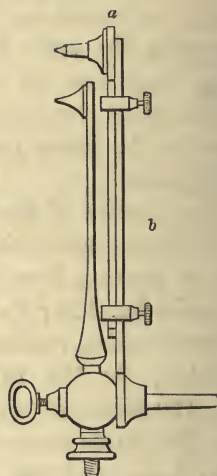

Fig. 125.



fixed at any position upon the lower half, *b*. The clamps when fixed, still permit the upper half to slide, but they also catch against projections formed at either end of *a*, and therefore determine the vertical traverse of the point, in both the upward and downward directions, within prescribed limits.

In producing say, 90 divisions from the 360 circle, as an example, the counting index is used as follows. The point of the *front* index is first placed in the 360 hole, and both clamps being slackened, the point of the *back* index is placed a little above it, in any hole of the same circle. It may be placed in hole 10. 12 or 14, the exact position not being material, so long as the point of the back, stands just above and clear of that of the front index. The two points remaining in their respective holes, the upper clamp, is brought up against the top projections upon the upper half of the back index, and is fixed there. This, prevents the point of the back index, when withdrawn from the division plate, from sliding any *lower*, than the position of the hole in which it has been placed.

The point of the back index is then alone withdrawn, slid upwards, and placed 4 holes higher on the circle, viz. in 14. 16 or 18. The lower clamp is then pushed down and fixed against the projections at the lower end of *a*, which prevents the point from sliding any *higher*, than the hole in which it is now placed. In other words, the clamps thus fixed, limit the vertical traverse of the point of the back index, to a distance equal to that of 4 holes of the 360 circle.

In taking the consecutive divisions upon the work with the counting index, the point of the front index is withdrawn and held just clear of the holes, by the thumb and forefinger of the right hand in the usual manner; the point of the back index, still remaining in the hole at the bottom of its traverse. The pulley is then turned away from the operator by the left hand, until it is checked, by the point of the back index having risen or traversed so far as the adjustment of the clamps permits, the interval of four holes. The point of the front index, is then dropped into the hole that is opposite to it, which is four holes in advance of its former position on the division plate. The front index point being inserted, it retains the mandrel and the work, in the required position for the divisions or marks to be made upon it; but, previously to the work being marked or cut, the point of the back index, in its turn, is withdrawn, slid downwards to the extent of its traverse, and replaced in the division plate, ready to measure the next division in the same manner. When the mandrel is turned towards the operator, the point of the back index pursues the reverse path, starting every time from the top of its traverse.

The following table shows the divisions of the circle, obtained from division plates containing the numbers 360. 192. 144. 120. 112 and 96; which numbers are usually found to give sufficient divisions for all ordinary purposes. The first column contains the number or division required, the other columns, the number of holes or divisions to be taken in the different circles.

TABLE OF DIVISIONS OF THE CIRCLE

TO BE OBTAINED FROM THE NUMBERS 360. 192. 144. 120. 112 AND 96.

Parts required.	Circle 360.	Circle 192.	Circle 144.	Circle 120.	Circle 112.	Circle 96.
2	180	96	72	60	56	48
3	120	64	48	40	...	32
4	90	48	36	30	28	24
5	72	24
6	60	32	24	20	...	16
7	16	...
8	45	24	18	15	14	12
9	40	...	16
10	36	12
12	30	16	12	10	...	8
14	8	...
15	24	8
16	...	12	9	...	7	6
18	20	...	8
20	18	6
24	15	8	6	5	...	4
28	4	...
30	12	4
32	...	6	3
36	10	...	4
40	9	3
45	8
48	...	4	3	2
56	2	...
60	6	2
64	...	3
72	5	...	2
90	4
96	...	2	1
112	1	...
120	3	1
144	1
180	2
192	...	1
360	1

The circle having the smallest number of holes containing the required intersections, is usually but not invariably, selected for easier and more convenient reading. Thus, to divide the work into twenty four parts, the table gives a choice among circles 360. 192. 144. 120 and 96. The 120 would in this case be preferable, not as the lowest number, but, because the number five occurs and is marked off as a divisor of 120, and is therefore easier to read than 4 in 96.

INTERPOLATION.

The divisions of the circle in the preceding table, require the index to be always of *unvarying* height or length, as it is applied from hole to hole; but other numbers, not aliquot parts of these circles of holes, may be produced from them with the *adjusting index*, by the method of differences, or interpolation.

In interpolation, the index itself continuously varies in length, its point being moved through a small space, together with the division plate, between every division marked on the work; with the effect, that when the index is moved in the *same* direction with the division plate the two quantities are added together, and the spaces marked out upon the work become so much the wider and less in number, than the divisions taken by the point in the circle of holes. When the index is moved in the opposite direction to that travelled by the division plate, the amount of its motion is deducted, producing the contrary effect; the divisions then obtained, being less in width and more in number.

The adjusting index fig. 123, is used for interpolation in the following manner. To obtain, for example, *thirty one* equal divisions of the circle, a reference to the table, gives three holes in 96 for thirty two; it has then to be ascertained by trial, how many divisions of the micrometer of the adjusting index, are equal to the one thirty second part of the 96 circle, which part has to be expunged, by being equally divided among the thirty one divisions required to remain. To determine their number, the mandrel is retained stationary, the point of the index is placed in one of the holes of the 96 circle, and thence, moved over exactly the distance between three holes, by its micrometer screw. This, it may be assumed, requires 124 divisions, which divided by 31, the number to be produced, gives a result of four. Therefore, by every time moving the division plate the three holes as for 32, and the index also 4 divisions of its micrometer, in the same *direction* for the difference; the one extraneous division, in the course of the entire circuit, will be equally divided among the 31, augmenting each a minute quantity, so that they exactly divide the circle.

It will however be more frequent that the number of divisions of the micrometer, will not divide without leaving a remainder. Supposing their number to have been say, 113, division by 31, would give 3 with a remainder of 20, which must be introduced among the whole, by making every movement of the index $3\frac{2}{3}$. When the micrometer is more finely divided, making the number in such case say, 289, every movement would correctly be $9\frac{1}{3}$; but 9. 9 and 10 divisions taken in continual succession, would probably suffice for many purposes, while it would save the trouble of dealing with fractions. On the same principle 27 may be obtained from 32, by measuring the value of five thirty second parts of the circle, and dividing that by 27; but it would be more judicious to obtain 27 from 28, in the 112 circle, as when the quantity to be dealt with is large, the inequality between the right line and the arc becomes of some consequence. In pursuing this method in the opposite manner, to *increase* 32 to 33 divisions, the difference measured by the index, is divided by 33 the number to be obtained, and the index and micrometer are moved in *opposite* directions. To simplify the use of the apparatus, the graduations are so numbered, that when the figures on the division plate and those of the micrometer of the index, both go on increasing, that is, read in the same direction, then the two movements are added together, enlarging the spaces; and on the other hand, when the two series of numbers are used in opposite directions, the motion of the one, deducted from that of the other, contracts the resulting spaces.

SCRIBING TOOLS.

For purposes not demanding any great degree of accuracy, a point tool, or the corner of a flat tool, or upon wood, a lead pencil, may be employed upon the tee of the hand rest, to scribe the divisions upon the work. A circular line or lines, to determine the commencement or termination of the length of the lines to be scribed, or to mark the position for the centers of a series of apertures, being first struck upon the work with a point tool or with the pencil.

The tee is adjusted in its pedestal with its top surface exactly to the height of center of the lathe, and is placed and

fixed with its edge almost in contact with the work. To avoid variations in the width of the spaces marked out, the tool or scriber is held horizontally, that is radially to the work, with its face flat upon the surface of the tee; but, the narrow width of the flat upon the top of the ordinary tee, renders this position rather difficult to maintain with accuracy, and errors are still more liable to occur, when from the form of the work, the edge of the tee cannot be placed close to the part to be divided. The method however is often sufficiently good for marking the terminal lines in first reducing the circular to the square or other form, and for finding the position to bore holes, for the insertion of other parts for construction or for ornament, as will be seen in the practical sections.

A tee with a wide flat top, is occasionally used as a means for preventing the tool losing its horizontal position. From this, the *dividing tee* fig. 126, used for more careful dividing, has been derived. The flat under surface of the scribing bar

Fig. 126.

Fig. 127.

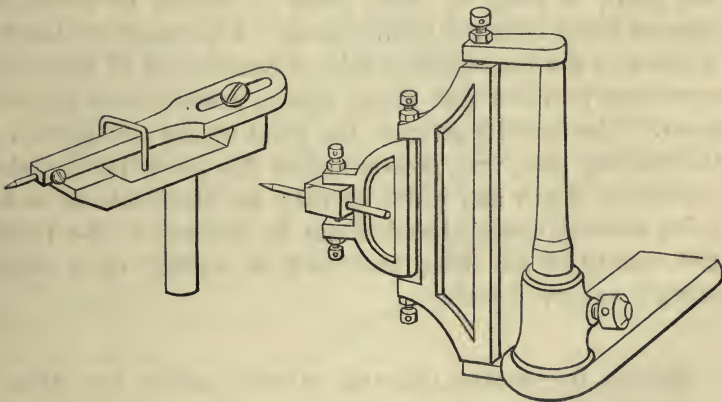

of fig. 126, lies upon raised surfaces at either end of a flat tee five or six inches wide, carried by a stem and adjustable for height in the pedestal of the handrest. The scribing bar works by a slot on a pivot at the back end of the tee, which permits it to advance or recede when scribing a long line, and in following the outline of curved forms. A bridle placed towards the front, prevents excessive lateral motion, and retains the bar fairly under the guidance of the front surface. The

scribing point of steel, can be removed for sharpening, and is fixed in a socket in front by a side screw.

The bar is held near the point end, between the thumb and two fore-fingers of the right hand, which at the same time keep it firmly pressed down upon the tee. The point is placed in the line traced on the work to give the termination of length, and is then pushed towards the right to scribe the division. The slot and pivot behind, allow the bar to work freely in respect of its length, and the point is made to cut to an equal depth by the sense of touch; care being principally required to keep the bar always equally pressed down upon the tee. Variation in this latter respect, even a momentary lapse of attention, will produce errors, arising from a trifling variation in the height of center of the point while the bar is in use; and such errors are very visible upon finely divided work.

The *dividing gate* fig. 127, used for micrometers and other works demanding moderate accuracy, is a superior tool. A rectangular block to be held between the fingers, which carries the point, is hung by three pairs of centers to a vertical support fixing upon the lathe bearers. Adjustment for height, is given by the intermediate pair of centers and all the center screws are provided with fixing nuts to prevent their displacement. The mobility given to the point by the construction of the dividing gate, very greatly assists the touch in obtaining equality in depth and width of cut; and the height of center being assured, entire attention can be devoted to the length and quality of the lines, that may be scribed upon either straight or curved work.

SECTION II.—BORING COLLARS, SLIDING GUIDES AND BACK STAYS.

The *boring collar*, is employed to support long works while the interior is bored or turned hollow, when it replaces the popit head. It is almost a reproduction of the collar shown by Bergeron, in the modification of the pole lathe fig. 22; used to support one end of all hollow works against the back center, previously to the introduction of the lathe mandrel. Now, hollow work of moderate length, is driven into a chuck to be carried on the mandrel without further support, and the

boring collar is usually only required when the work is too long to be safely carried in this manner.

The necessity for the application of the boring collar, is determined by the relative length and diameter of the work. Thus, in wood or ivory turning, a piece half an inch diameter and three inches long, securely fixed in a chuck, may be safely hollowed with the turning tool without support. But, if the work were twice as long, it would probably be displaced from the chuck, and the extreme end would also run some risk of splitting unless the boring collar were used. On the other hand, if the diameter of the piece six inches long were increased to two inches, it would be hollowed without support. In metal turning, the works requiring support lie within much narrower limits.

The modern boring collar, fig. 128, consists of a circular iron plate with a series of conical holes, equidistant from a

Fig. 128.

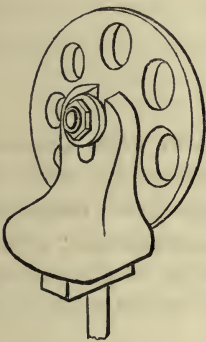

Fig. 129.

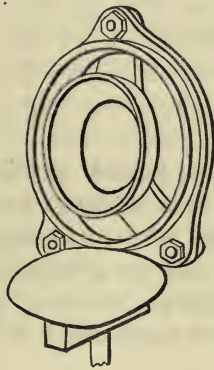
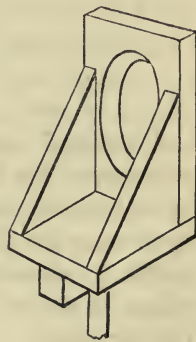

Fig. 130.



central pivot or bolt. It is carried by the bolt upon an iron head, having a tenon fitting between the bearers, secured beneath them in the usual manner. The collar plate turns on its center to place any hole vertical, and opposite the axis of the mandrel; in which position it is fixed by the screw and nut upon the pivot. The large ends of the holes are placed towards the mandrel, and the series serves for works of all diameters that are between their extremes.

The hole employed is first adjusted for centrality. This

may be done, by placing upon the mandrel a chuck or a piece of wood in a chuck, the edge of which when turned true, may be contained within the cone of the hole. The pivot being slackened, the mandrel is then set in gentle revolution, and the collar plate is allowed to adjust itself by contact with the chuck, and is then fixed by the nut. It may also be adjusted to the end of the work itself, which may be supported in position while revolving, for the time being, by the center of the popit head, afterwards removed. With very little practice the popit head may often be dispensed with, as the hand and eye alone, frequently suffice to adjust the hole truly to the end of work; especially when, as it should be, the exterior of the latter has been turned true.

The centrality of the hole of the boring collar to the mandrel axis, in both directions, is necessary to avoid undue friction, and to obtain truth or agreement between the internal

Fig. 131.

B



and external surfaces turned on the work. Its accurate adjustment for use when drilling, receives especial care, in order that the mandrel, work, drill, and popit head, employed to advance the latter, may be all in one continuous line; which would be distorted by an incorrect position of the boring collar, as shown in an exaggerated degree, at the point B, in the line above.

The boring collar is not usually provided with any adjustment in the direction of the length of the bearers, for giving pressure upon the end of the work; but is simply moved up by hand into easy contact and then fixed. Should further adjustment be found necessary, the bolt beneath the bearers is slightly released, and the plate is advanced into closer contact, by light blows of a wooden mallet directed against the lower part of the head, and the bolt is then refixed; if a hammer be used for the purpose, a piece of wood is interposed to receive the blows, to avoid injury to the face of the head.

Additional plates are occasionally required for very small work especially in metal turning, these are usually thinner and of brass, and the holes are frequently bored in them to suit the diameters of particular works as they arise. The holes in the plate of fig. 128, are found to afford sufficient range for general purposes, but, they are necessarily limited in diameter by the position of the central bolt; for works of larger dimensions, the plate is bored with a single central hole, and is attached to the head by bolts below, as in fig. 137, or, in some other manner.

The head of the large boring collar, fig. 129, is formed as a concentric ring or frame, cast in the solid with the base, which fixes in the usual manner on the lathe bearers. Separate, central, conical rings, are attached to the frame by three bolts, and the number of these rings may be extended so as to embrace a wide range of diameter; the smaller rings are provided with arms or ears in the solid, through which they are bolted to the frame. For an occasional purpose, in wood or ivory turning, a collar plate of large diameter, may be constructed in wood, after the form of fig. 130, and used with fair success. All the collar plates, require the hole to be frequently supplied with oil, grease or soap to relieve the friction, for which purpose also, the edge of the work should be turned true and chamfered to nearly the same cone as the hole; the extension of surface contact preventing their mutual injury. With works in metal, the agreement of the two cones receives careful attention; but for many small works in wood or ivory, when these are turned true and surfaced, the mere removal of the sharp corner from the end of the work will suffice for the purpose.

GUIDES FOR SLENDER TURNING.

The elasticity of turned works that are long compared with their diameter, causes them to spring or bend away from the cut of the turning tool. The tendency to spring is also variable upon every piece, being less when the tool is near the ends, or points of support, and most, when it is in operation about the center of their length. This elasticity interferes with the true revolution of the work, and tends to produce a varying and irregular oval instead of a true circular section.

Various contrivances simple and complex, have been employed as guides for slender turning, to prevent the work springing away from the thrust of the tool. The hand alone, affords the readiest assistance for those long works, in which much accuracy is not required. The fingers of the left hand are placed around the work from above, to support it and oppose the tool; the left thumb being pressed upon the face of the tool, both, to assist its guidance by the right hand and also, that the supporting hand may travel with it along the work. Very delicate, slender works mounted between centers, or when fixed in a chuck by one end only, can be supported by the left forefinger alone, placed around them from below; the inner side of the first joint, or sometimes the tip of the finger pressing the work against the tool. This requires a little practice, the thrust of the tool on the one side having to be met by only just sufficient pressure by the finger on the other; the eye and the sense of touch modulating the force of each, so as to keep the work in true revolution between them. Nevertheless, it is frequently the only method available and when skilfully managed is very successful.

The simplest mechanical support, is that afforded by a stick fig. 132, placed between the bearers, and forced against the work by a wedge. The stick is moved from place to place as

Fig. 132. 133. 134. 135. 136. 137. 138.

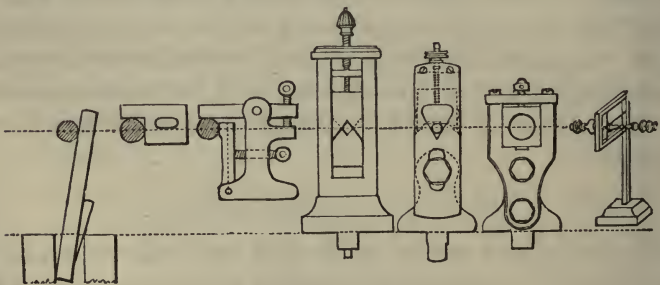

the work progresses, that it may follow the tool, and the pressure from the wedge is lessened, as the work becomes reduced in diameter. This method is that employed, but with the stick horizontal instead of vertical, by the Arab turner and others, using the bow lathes already described. The Arab uses either a plain stick, or for boring and internal turning,

two jointed together with a semicircular recess in each, forming a hole to embrace the work, fig. 8; the same contrivance roughly serving, both as guide for slender turning and as boring collar.

The small block of wood or metal fig. 133, filled out with a rectangular notch, touches the work at two points instead of one. It is attached to a pedestal fixed on the bearers, by a bolt passing through an elongated hole, longer and rather wider than the diameter of the bolt; permitting the block a small adjustment on its support. This arrangement is employed for wood and metal turning, and may be sometimes mounted on the base of the handrest. The two pieces jointed to the base, fig. 134, are similar in their action, but more convenient from additional power of adjustment.

Fig. 135, is an early arrangement of two independent slides, each having a vertical traverse by screws fixed in the pedestal, and forming a square opening adjustable to the size of the work. Fig. 136, has one slide forming a triangular opening; it is attached by a bolt and nut to an independent head, usually that of the boring collar. The circular divided collars in fig. 137, are made of wood, tin or brass, and are carried in an iron frame with a pressure screw; the frame has a limited power of adjustment upon the head by which it stands on the bearers, and several pairs of collars are required to suit the sizes of different works. This guide is principally used for metal turning.

Fig. 138, copied from Bergeron's work, is used for supporting very light works in wood and ivory, that are too delicate to bear even their own weight in the horizontal position; these slender specimens, turned as examples of dexterity, being generally of an ornamental character and of great length compared with their diameter. The portions of the work most distant from the chuck, while the remainder of the material is still strong, are first reduced and then completely finished, a small length at a time, commencing at the extreme end. So soon as the length of the attenuated portion renders it necessary, it is supported while in revolution and its consequent gyrations restrained, by fig. 138. The adjacent succeeding portions of the work are then reduced and finished, and so on, proceeding gradually onwards towards the base of

the work in the chuck; two or more of the supports being used, according to the length of the piece. Fig. 138, is formed by stretching double silk threads across a wood frame, the work being in the interstice between the four.

The *guide for slender turning* figs. 136, and 139, is perhaps the most generally useful. The external surface plates are pierced by a central, equilateral, triangular opening, point

Fig. 139.

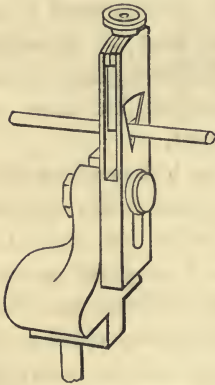

Fig. 140.

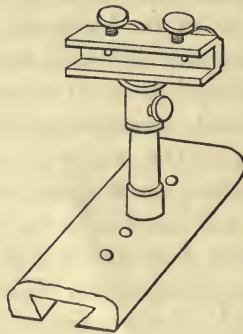

Fig. 141.



downwards. Contained between them, and adjustable vertically by a thumb screw, is a third or central plate, of which the lower edge forms the upper side of the triangle, and by its depression diminishes the size of the opening. The apparatus is carried upon the head of the boring collar fig. 128, by a slot in the lower half, which permits its vertical and radial adjustment upon the fixing bolt or pivot, as with the boring collar.

To adjust the guide for use, the pivot is slackened and the apparatus placed in position upon the bearers; the aperture is then closed upon the work by the thumb screw, the vertical and radial adjustments being found, as with the boring collar, by putting the work itself in gentle revolution, and when the latter is found to run truly without undue friction, the pivot is refixed. The work is usually supported by the popit head, the sliding guide being placed close to the hand rest, near to the tool, and always if possible, on a portion of the work in a still unfinished state, in order that any marks it may leave on the surface may be ultimately removed.

BACK STAYS.

The guide for supporting the work when the tool is employed in the slide rest, is distinguished as the *back stay*; it is required for the support of rods and long screws, and has to travel along the work at the same rate as the tool. The pedestal therefore can no longer be fixed upon the bearers as in the previous examples, but is attached to the saddle plate carrying the slide rest; and the rod or screw to be turned is also always supported by the popit head. The guide portion of the back stay for metal turning, is very generally made after one of the forms indicated by figs. 133, 134 or 137. Fig. 142 being another and stronger arrangement.

The pedestal of the back stay for the lathe fig. 114, is continued below in the form of a bridge, which avoids any interference with the traverse of the lower slide of the slide rest. It is bolted on either side to the saddle plate, the bolts passing through elongated holes, fig. 143, giving it a small power of transverse adjustment. The backstay itself, is formed of two pieces or jaws of metal, jointed together at one end, kept apart by a steel spring, and compressed upon each other by a screw in a bridle attached to the lower jaw. It is attached to the upright, by a bolt, nut and spring washer. The bolt is less in diameter than the width of the opening between the upper and under jaws; through which it passes, and the washer, which is wide, concave and rather thin, to act as a spring under the nut, bears by its ends upon both jaws. The upper jaw carries a piece of hardened steel filed with a notch, forming a triangular opening with the lower; the two jaws closing upon and touching the work at three points. The size of the opening is contracted as the work progresses, by the pressure of the bridle screw, and varied to receive work of different diameters, by exchanging the steel piece in the upper jaw for others, fig. 144, with larger openings or notches.

The arched support is first fixed to the saddle of the slide rest, the jaws of the back stay are then opened and placed upon the work and the bolt passed between them and through the upright. The upper jaw then rests upon the work and upon the fixing bolt, which latter is at first screwed up by the fingers only. The jaws having been previously oiled, are then

adjusted to fit or rub upon the work by the bridle screw, after which the attaching bolt is further screwed up. The backstay can be placed on either side of the upright, as may be more convenient for the work; but relatively to the cut, it is always

Fig. 142.

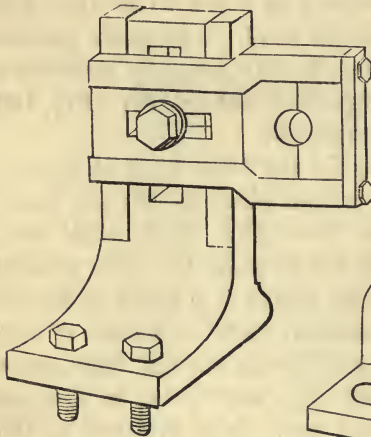
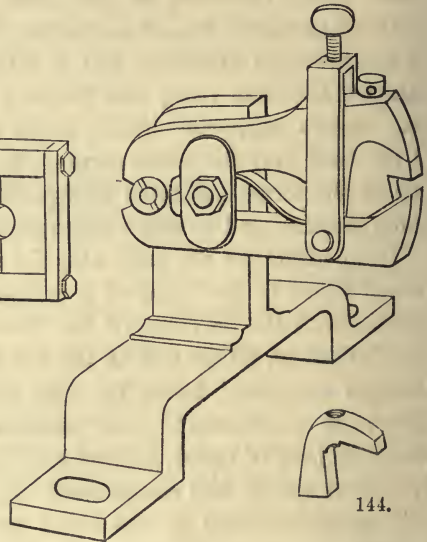

Fig. 143.



placed so that its support falls upon a point, slightly to the right of that which receives the thrust of the tool. It therefore always bears upon a surface, just previously completed by the tool, and meets with no impediment to its traverse.

The backstay shown by fig. 140, is sometimes used with the slide rest for ornamental turning, for the support of long and delicate pieces during their ornamentation with the drilling instrument or revolving cutting frames. A slip of hardwood, shown in section fig. 141, with a longitudinal groove or a series of notches, cut to roughly fit the form of the work, and altered from time to time as that progresses, is carried in a rectangular trough about three inches long. The wood is held in its place by two thumb screws from above, bearing upon its side, and is pushed forward from behind, by two similar screws equidistant from the center of the length of the trough. The latter, is mounted on a cylindrical stem, capable of vertical adjustment and provided with a fixing screw. The

socket in which the stem works, being attached to and removable from the rest bottom, by screwing into a short series of holes tapped in its upper surface.

The guide is first adjusted vertically to the height of center, and then, while the binding screw in the socket is still sufficiently slack, the slip of wood is advanced into contact by its pushing screws; it is then secured by the two thumb screws above, after which the stem is fixed by the binding screw in the socket. The circular or swing motion of the stem within its socket, together with the independent action of the two pushing screws, allows the guide to be very gently and exactly adjusted for the support of the most delicate or fragile ornamental work.

SECTION III.—THE SLIDE REST. SLIDE REST TOOLS.
MANIPULATION AND ADJUSTMENT.

The true cylinder or surface, is produced with sufficient facility with the tool under the guidance of the unassisted hand, in the manner described in the chapters on elementary turning. The process however is often of rather a tentative character, and the work requires constant testing with the callipers and straight-edge during its progress, to prevent the surface or cylinder being turned concave or convex, and to ascertain the parts in excess that require reduction to the general level. Moreover when apparently complete, it may require repetition, should the measurements show the tool to have made too deep an incision at any one spot; in which case the entire superficies has to be reduced to this new level.

The slide rest supplies mechanical guidance to carry the tool in a true straight line along the work, at once producing the true surface, cylinder, or cone, separate or in combination; with the material advantages of certainty and rapidity of result, economy of material and physical labor; which conduce to its general adoption on the lathe in some one of its forms. It is a necessary part of the slide or traversing lathe and is largely used upon all others, from those of the watchmaker to the largest steam power lathes, both for plain turning and for many purposes yet to be referred to.

The *slides* of the slide rest, along which the tool carriage is made to travel, give the path of the tool; so that the resulting

accuracy or otherwise of the work, depends entirely upon that of the slide rest. The slides and plates of which it is composed, therefore, should be flat as surfaces and also true as straight-edges in the direction of their length. The upper and under surfaces of every piece, should be precisely parallel to one another, that when the several parts are superposed, the tool may travel in an absolute straight line, and also remain at precisely the same vertical height at all parts of its traverse. The main screws employed also require considerable accuracy, to move the tool a definite distance and for other purposes. Indeed it may be said, in view of the valuable assistance rendered by the slide rest, that it is hardly possible to bestow too great care upon its construction: when correctly made, both its screws and slides are prepared by those methods which obtain the greatest accuracy, processes, already fully described in the second volume of this work.

Slide rests employed for plain turning with the ordinary foot lathe, are usually made with either two, or three slides. Fig. 145, is one variety of the former, fig. 146, and fig. 599, Vol II., are different forms of the latter. The lower slide in

Fig. 145.

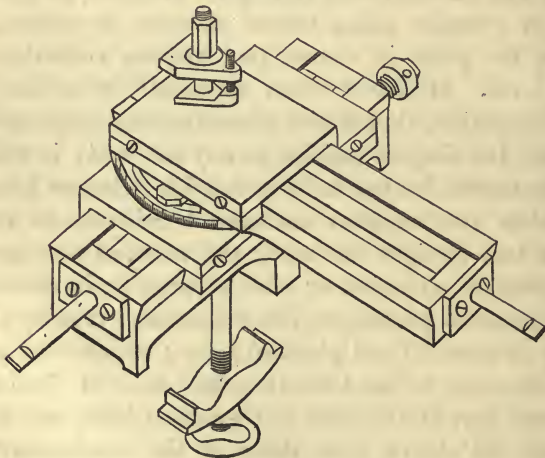

fig. 145, which traverses the tool for turning the surface, stands at right angles to the lathe bearers, its correct position being ensured by a tenon cast upon it in the solid. The tenon, which is placed between the lathe bearers, is rather less in

thickness than the width of their opening, and its more distant face, which should be exactly at right angles to the lower slide, is brought up *against* the further side of the interval of the bearers by the tail screw shown. When thus adjusted, the rest is fixed by a bolt screwing into the tenon, with nut and washer beneath the bearers. The lower slide is provided with a main screw of some definite number of threads to the inch, working in a nut attached to the under side of, and traversing its top plate. The top plate, exactly fits the surface and chamfered edges of the lower slide, and is furnished on one edge with suitable adjustments to allow for wear; it carries the upper slide upon its surface, upon a stud or pivot about the center of its length. The upper slide, which traverses the tool for turning the cylinder, is of the same general construction as the lower, and turns on the pivot as on a center; it is attached to the plate beneath it, by two bolts working in semicircular mortises, to permit the upper slide to be fixed at horizontal angles to the lower, for turning cones. The main screw of the upper slide agrees in pitch with that of the lower, both screws being actuated by winch handles fitting upon their projecting ends.

The toolholder of fig. 145, mounted on the top plate of the upper slide, is that contrived by Professor Willis; clamping tools of various sized shafts, even when these are irregular in thickness. It allows the tool to be presented to the work at all horizontal angles, so that a tool with a straight stem can be applied as well to undercut work as to the surface or cylinder; it also serves to carry various revolving tools applied to metal, as for wheel cutting and slotting. The construction of Professor Willis' tool holder, is described, and shown by figs. 1007, 1008, Vol. II.

The slide rest with three slides, fig. 599, Vol. II., is similar in construction to that just described, in addition it carries a third or tool slide, without the circular motion, upon the top plate of the second, which thus becomes the middle of the three slides. These are arranged as in fig. 145, the lowest across the bearers, the middle parallel with them, and the top slide again across. In this rest, the three slides are principally required to connect it with the mandrel for screw cutting, and when the lowest has placed the middle slide in its position, at

the distance from the axis of the mandrel required by the diameter of the work and the train of wheels in use, the tool is advanced to the cut by the top slide.

In fig. 146, the lowest or third, is a plain slide, traversing in a gun-metal cradle. The sides of the cradle stand square across the bearers, being retained in position by its tenon and a tail screw, the latter not seen in the figure. The plain slide is represented as drawn out nearly to its fullest extent, and when it is adjusted for distance, it is first fixed by a set screw at the side; the edge of the slide being protected from injury,

Fig. 146.

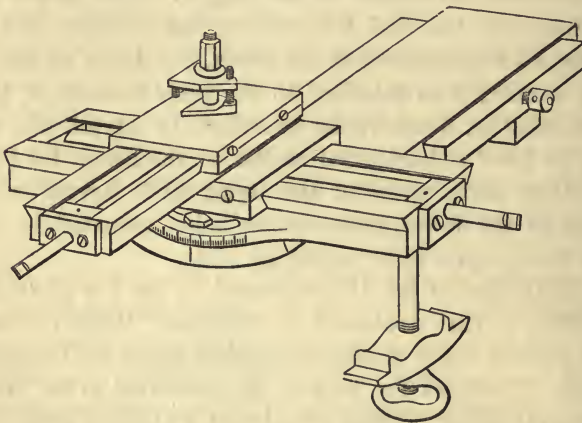

by the interposition of a thin slip of steel attached to the inner side of the cradle. The plain slide lies directly on the bearers, with which it is brought into close contact, when the rest is secured for turning, by the bolt screwing into the tenon of the cradle from beneath. The middle or second slide, traversing the tool for turning the cylinder, is provided with a screw and is of the same general construction as those previously described; it is carried on a pivot at the end of the plain side, to which it is fixed by bolts working in circular mortises, placed at the center of its length. The first or top slide, turning the surface, carries the tool holder.

The plain third slide of fig. 146, rapidly adjusts the position of the middle slide, to accommodate the diameter of the work

in plain turning, or the length of the train of wheels in screw cutting; and while sufficiently strong, occupies much less vertical height than the bottom slide of either fig. 599, or fig. 145. The screw slides of fig. 146, may stand either directly over the bearers, for work of small diameter, or quite clear of them, as drawn. In which latter position, the small height occupied by the third slide allows the turning of cylindrical work of much larger diameter, than can be accomplished with either of the others; the relative difference in diameter, being nearly that of 3 to 2.

In traversing lathes, the lathe bearers, main screw and saddle, may be compared with the lowest slide of a large slide rest; upon the saddle or top plate of which, the remaining parts are carried. In the lathe fig. 114, these will be seen to consist of two slides, similar in construction to those already described; the lower, standing across the bearers and fixed by bolts in undercut grooves, giving it a power of adjustment on the saddle; the upper slide, is attached to the plate of the lower, by the circular motion and fixing bolts, for horizontal angles.

The mutual wear, caused by the friction between the screw and its nut in the slide rest, claims a few words. Absolute or perfect contact between the two is inadmissible, as were it to exist they would be immovable; in addition to which, the original extremely slight, but necessary freedom, to allow motion between the two, gradually increases with use.

Wear always takes place upon the *one* side of the threads of each that are in contact, when the screw is turned in the one direction, and upon the *opposite* sides of each, when the screw is turned in the reverse direction. Both nut and screw, are thus worn on both sides of their threads, the hollow or internal thread in the nut, becoming wider, and the solid or external thread of the screw, becoming narrower; by which process the shake or endlong motion between the two, is gradually and after long use, greatly increased; being also the most, about the center of the length of the screw. The deterioration allows a more or less considerable motion of the screw, when that is reversed, before the contact is transferred to the respective opposite sides of the threads.

The break of contact, called *loss of time*, is visible on reversing the motion of the winch handle, which turns through a portion of its circle, according to the wear, before the screw produces any effect in reversing the traverse of the tool. Loss of time in the slide rest screw is of little importance in plain turning, but it interferes when the rest is employed for screw cutting or for ornamental turning; yet as will be seen, its effects are easily neutralized by correct manipulation. Adjustable nuts, referred to, page 664, Vol. II., and shown by figs. 622 to 625, are occasionally employed to compensate this wear, when necessary, in delicate machinery, but such contrivances are hardly requisite for the slide rest screw. The main screws of slide rests are sometimes protected by thin steel covers passing through their nuts above them, or by other arrangements; this is desirable to prevent the access of dirt or turnings, particles of which, finding their way between the threads of the screw and the nut, greatly accelerate their mutual wear.

The strong slide rests shown by figs. 145 and 146 are employed for plain turning in wood and metal, for accuracy of result and to save expenditure of time and exertion; for roughing out or the preparation of materials, and for turning work requiring greater strength than is afforded by the unassisted hands. The slide rests employed for ornamental turning may also generally be used for light plain turning, especially for that, requisite to reduce to precise truth the different portions of the work about to be ornamented; but, it is good practice to first prepare the work true or concentric and nearly to the required size, with the stronger slide rest, or by hand turning. The description of slide rests for ornamental turning will occur in a later volume; but, it may be mentioned here, that it is advisable to limit as far as possible the extent of their application to the purposes of plain turning, to avoid all risk of impairing their superior delicacy of construction.

SLIDE REST TOOLS.

The tools and cutter bars used in the slide rest for plain turning, are analogous to the hand tools, in the forms and angles of their cutting edges. But, as the true, unyielding guidance of the slide rest, leads to the removal of a thicker

and more continuous shaving; their cutting portions in most cases, are made both narrower and stronger, to allow for the increased strain and for the inability of the tool to yield to it, when overloaded by the cut. The stems are rectangular to clamp in the tool holder.

Fig. 147.

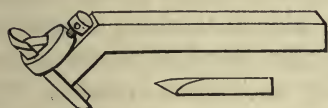
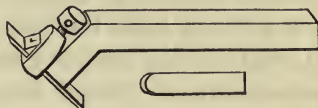

Fig. 148.



The gouge and chisel are applied in the slide rest, made as separate blades, that are fixed in the cutter bars figs. 147 and 148. The blades are securely held against the end of a bent stem by a steel band and screw, which also permits their exact adjustment to the height of center, and their ready withdrawal from the stem for sharpening. For which latter process, the small blades too short to be conveniently manipulated by the fingers, are fixed in the line of the shaft of appropriately formed socket handles. The angle of the end of the stem of the cutter bar, ensures the tangential position of the edge of the blade to the work, producing excellent results upon either hard or soft wood. The square edge of the chisel blade is employed upon the cylindrical and surface portions of the work, and to turn the square corner called a "shoulder," formed by the meeting of the two. Similar blades having the corners rounded or ground away below the level of the cutting edge, produce a very smooth surface, upon the plankways of the grain.

The slide rest tools, drawn mostly face upwards, figs. 149 to 162, represent the forms generally in use. The tools should be made of cast steel, with strong parallel stems, usually from half to threequarters of an inch square, and from about six to eight inches in total length. For turning hardwood their edges vary from about one eighth to about half an inch in width, with cutting angles of from 40° to 80°. The smaller tools for plain turning, of the form of fig. 1048, Vol. III.; may also be used for light work, when placed in a strong tool

holder or shaft, having a rectangular aperture suitable to their stems, in which they are secured by a set screw.

The *round* tools figs. 149 and 150 are used for roughing out the work to shape. The *right side* fig. 151, the *flat* fig. 152, and the *left side* fig. 153, are employed upon external and internal surfaces and cylinders. The side and end cutting edges of these three tools, meet on the face at an angle less than 90° , to permit them to be carried quite into internal square corners, when working upon the cylinder, without touching or marking the neighbouring surface; and in like manner, to traverse an internal surface, without touching the internal cylinder. The *point* tool fig. 154, is employed for grooves, and with the point

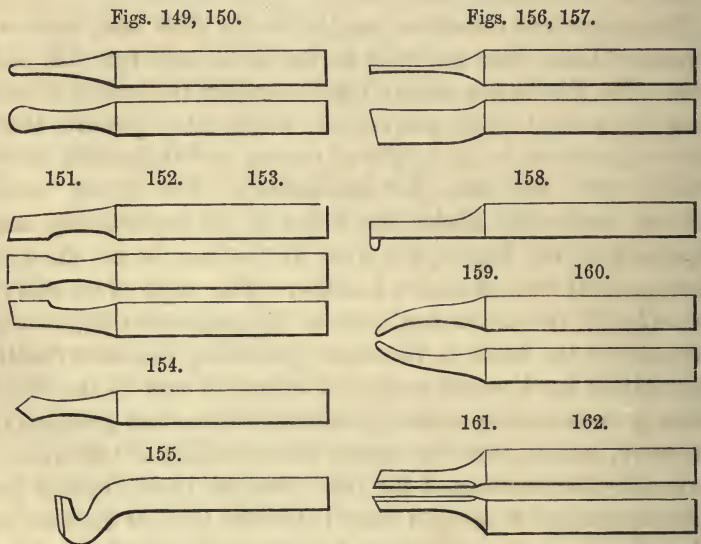

slightly rounded, for turning the cylinder. The *parting* tool, shown upon the face and upon the edge figs. 156, 157, used for dividing the work from the portion in the chuck, and for cutting grooves, is long and narrow on the face, strengthened by considerable depth in the other direction. The *inside* tools figs. 158 to 160, have their cutting edges overhanging the sides of their shafts. Fig. 158, is used for enlarging or roughing out apertures, fig. 159 for finishing them; during which latter process, the cut is usually taken by drawing the tool from the bottom outwards.

The same generic forms, obtain among the slide rest tools for iron and brass turning ; but, on account of the increased hardness of the materials, the edges of the tools are modified in width, generally by reduction, and also as to their cutting angles. The latter for iron, are increased to from about 60° to 80° , and for brass, to from 70° to 90° ; as the tools may be required, respectively, for rough turning or for finishing.

The various cutter bars with separate blades, employed for metal turning ; the *side* cutting tools, figs. 161 and 162, for *external* turning upon cylinders ; the crank formed tool fig. 155, perhaps the most useful of the tools for metal, in its numerous varieties ; together with all the foregoing, having already been thoroughly discussed and portrayed, as to their principles, forms and cutting action, in the second volume of this work, it is not proposed to enlarge upon them here, but, to proceed instead to the manipulation required with the tool and the slide rest.

MANIPULATION OF THE SLIDE REST.

The construction of the slide rest ensures the tool travelling forward in either direction, in one horizontal plane ; but, it is also essential that the face or cutting edge of the tool, should be at precisely the same height as that of the axis of the mandrel ; that the tool may travel radially and horizontally, between the circumference and center of the work.

For example, when turning a surface, if the tool be supposed to be a quarter of an inch *below* the height of center of the lathe, it would cut towards the margin, but on arriving towards the center, it would cease cutting and pass below it ; leaving a space at the center half an inch in diameter, untouched. A tool used below the center, would still sooner cease cutting and rub in turning the cylinder, which latter as it became reduced in diameter would soon overhang the edge of the tool, which would probably break from the strain, page 528, Vol. II. If the tool be *above* the correct height, it will in like manner, leave a corresponding portion untouched at the center, when used upon the surface. While upon the cylinder, the cutting contact between the edge of the tool and the work is gradually transferred, by the reduction in diameter of the latter, to contact between the work and the back or

non-cutting portion of the edge, the tool ceasing to cut and being arrested by friction. The height of center of the edge of the tool is therefore first adjusted, and with greater care for works of small diameter, or for internal turning, in which latter the tool still sooner rubs instead of cutting, when incorrectly placed in this particular.

The top plate of the slide rest upon which the tool lies when clamped, is below the center, and the stems of the tools may be made of a corresponding thickness, to cause their faces to lie sufficiently nearly central. More usually the stems of the tools are made of less depth and thin parallel pieces of metal, of a length *equal* to that of the stem, are placed beneath them to *pack* the tool to the required height; such lifting pieces being always required with those tools in which the cutting edge has been so far ground away by sharpening, as to stand beneath the correct level. The tool is usually adjusted or packed to the height of center, by approaching its cutting edge as it lies on the top plate of the rest, either to a pointed center chuck on the mandrel, or to the point of the popit head, and then, one or more of the thin lifting pieces are placed beneath it, as may be necessary.

The production of smooth well finished turning with the slide rest, is greatly assisted by preventing, or at least diminishing, any vibration in the tool. With this view, the shaft of the tool is supported as much as possible when clamped in the holder, the cutting end being allowed to project no further beyond the edge of the top plate than is absolutely requisite. Regularity in the traverse of the tool, whether that has to be equal, increasing or diminishing, is also necessary, the winch handle upon the screw moving the tool is therefore always turned in a careful regular manner, but, with greater or less speed according to circumstances.

Should the tool be traversed too rapidly for the diameter or material of the particular cylinder upon which it may be engaged, it cannot remain a sufficient time at all parts of its transit, to remove the shaving equally from all along the entire superficies; and the cut produced then has the appearance of an irregular screw line, from having passed over or escaped portions of the original surface. On the other hand, if the tool be made to linger too long, the unnecessary friction

with the work assists to more rapidly blunt the cutting edge. The requisite pace of traverse can hardly be precisely stated, as it depends upon the material under operation, its diameter, the speed at which it revolves, and the amount or depth determined to be removed at every cut; the last factor, sometimes with the larger lathes, depending mainly on the strength of the work and the apparatus. But, it may be said generally, that the larger the diameter of the work, the harder the material, or the heavier the cut, the slower of necessity must be the traverse of the tool.

The pace of the tool is the most rapid, and the depth of cut the greatest, in turning softwood; both being principally limited by the tendency of the tool to cut roughly and bury itself in the work, when either is in excess. The hardwoods, more rapidly deteriorate the edges of the tools, with these therefore, the pace of the traverse is reduced about one-half, and the depth of cut still more. Brass, may be turned at nearly the same rate as the hardwoods, the softer metals more quickly. Iron and steel, which are principally turned with narrow pointed tools, require again a much slower rate in the traverse, with diminished depth of cut, for all ordinary work; the depth of cut in heavy iron turning however, being determined conjointly by the strength and size of the work, the strength of the lathe, and the power available for driving it. Lastly, the surface velocity of the work has also to be taken into account, this, requires a slower pace for work of large than for that of small diameter. Various diameters requiring different rates, occur in the various portions of the same solids, or combined, as in the surface; upon which the tool has to be gradually accelerated, as it advances from the circumference to the center, and retarded, when travelling in the opposite direction; so as to equalize the progressive surface velocity at the point of the tool, and to maintain a nearly constant amount in the cut.

The traverse of the tool being guided by these generalities, the amount or depth of cut taken by every traverse upon either a large or small diameter, with a properly constructed tool, ground to the correct angle for the particular material being turned; should be *limited* to, and is pointed out by, its fair cutting action. The fair use of the tool, is rather within

its full powers; and this is shown by the regularity in the appearance of the cut, the continuity of the shaving and the smoothness of the result. It also has the advantage of causing the cutting edge to last longer, and is therefore eventually the more economical in point of expenditure of time. When, on the other hand the depth of cut is in excess, the undue strain or *overloading* of the tool, results in a rough or torn surface upon the work; which is also frequently accompanied by the fracture of the cutting edge. The rough or torn surface thus established is at all times difficult to obliterate, having a tendency to perpetuate itself through the subsequent lighter finishing cuts. The work should therefore be first reduced nearly to size by a series of moderate cuts, and subsequently finished or turned smooth by a few fine cuts of less depth.

In first turning cylindrical works, the tool is made to travel from end to end, by reversing the direction in which the screw of the traversing slide is moved. The tool being *set in* at each end to an increased depth of cut, at the termination of every trip, by the slide that is at right angles to that by which it is traversed. The increased depth for the finishing cuts is given at one end only, as the tool starts in the one direction, towards the lathe head; on its return, and at all times that the tool is not intended to cut, it is withdrawn just clear of contact with the work, during its traverse back to its starting point. Upon the surface, the occupations of the two slides are reversed, that which on the cylinder gave the depth, now giving the traverse, and in turning forms in which the cylindrical and surface portions meet, the tool may be led along the one and withdrawn along the other, cutting upon either, indifferently.

The winch handle is commonly employed to regulate the depth allowed for the advance of the tool; thus, if the main screw of the slide rest be supposed to have ten threads to the inch, one complete turn of the winch handle advances the tool to the depth of one tenth of an inch, frequently a suitable quantity for wood turning. For finer cutting and for turning metal, the half, quarter, eighth of a turn, or less, is given to the winch handle, and this manner of advancing the tool, is sufficiently definite for most purposes of plain turning. For a more delicate advance, and as described in the chapter on

screw cutting, the main screws or the winch handles sometimes carry a circular plate or micrometer head, divided into a number of equal parts, with a fixed reading point, by which arrangement the most minute advance may be regulated and imparted to the tool. An adjustable stop is sometimes employed to determine the extent of the depth or forward traverse of the tool slide, used in turning several duplicate pieces. This is either a simple piece with a power of traverse affixed to the slide, so as to abut against the top plate, or a fixed piece, carrying an adjusting screw, fulfilling the same purpose. The arrangement aids in attaining a fair agreement in first turning down the work nearly to size, but in metal turning, from the sensible wear of the point of the tool, and also on account of its frequent removal for grinding, the work still requires careful measurement towards its completion; the stop may then be removed out of contact, or gradually withdrawn, to permit a further small advance to be given to the tool for finishing the work to its exact diameter.

THE ADJUSTMENT OF THE SLIDE REST TO SURFACE AND CYLINDER.

Slide rests constructed with every precaution require to be finally adjusted upon the lathe bearers, that they may subsequently turn the true surface and cylinder; this adjustment which merits a few words, is usually readily effected, and with fig. 145 or fig. 146, as follows. The under side of the slide rest fig. 145, its tenon and the lathe bearers, are first studiously cleansed from the accidental adhesion of dirt or turnings; the rest is then placed on the bearers, the tenon screwed up by the tail screw into contact with the further face of their interval, and the rest clamped in position by the bolt and nut below. The top plate of the upper slide, is placed towards the end of its traverse, as in fig. 145, and with a round tool clamped in the holder, the rest is applied to turn a surface.

The test surface turned, should be nearly as large as the lathe will admit, and is generally of hardwood. This material being chosen from the facilities it affords for the preliminary trials, while with care, it may also be made to answer tolerably well for the final tests. In addition, the comparatively slight

wear it occasions to the edge of the tool, greatly compensates for the deficiencies of a hardwood, compared with a metal surface, as applied to this purpose.

The surface that is produced by the first traverse of the tool, is tried by a steel straight-edge applied across its center. This, may show it to be not an absolute surface, but an exceedingly obtuse cone, either concave or convex; usually caused by the tenon of the rest not being positively square with the lower slide. To correct this error, the face of the tenon in contact with the bearers is sparingly reduced with a file, or scraper; principally at the right hand end, and diminishing away to nothing at the left hand end, if the surface be convex, and from left to right if it be concave. A very small quantity correctly removed from the face of the tenon, effects a marked difference on the surface produced by the traverse of the tool; for, the *actual* amount of error in the squareness of the tenon to the slide of the rest, is not only doubled by appearing on both sides of the center, but is also multiplied, by the distance from the center travelled by the tool; making the error much more apparent with increased diameter in the test surface. After the first alteration to the face of the tenon, the rest is replaced and the surface is turned a second time and re-measured; and the correction of the tenon is repeated, until the surface turned satisfactorily meets the test of the straight-edge. Some care however is required throughout to avoid over correction, which may easily occur and would throw the error the other way, and also to keep the bearers and the under surfaces of the slide rest free from dirt or chips, the interposition of which, would cause fallacious appearance of error.

The adjustment of the upper slide to turn the true cylinder, follows that for the surface. The tool is placed at right angles to its late position and set to turn a hardwood cylinder. The examination of the result with the straight-edge, serves only to show the truth or otherwise of the straitness of the upper slide of the rest; the parallel position of the latter to the mandrel axis, has to be ascertained by measurement with callipers, applied towards the two ends of the cylinder. One end will probably measure a larger diameter than the other; in which case, the bolts of the circular mortises are slackened, and the end of the slide, opposite the large end of the cylinder

is slightly advanced. The distance the end of the upper slide is advanced, is required to compensate only half the difference in the diameters of the two ends of the cylinder; the real error in position of the slide, in a similar manner to that first adjusted to the surface, being also doubled and then increased, according to the length of the cylinder. Therefore towards the end of the corrective process as truth is approached, the requisite advance to be given to the end of the upper slide becomes so very slight as to be easily carried to excess, which then throws the error the other way. The trifling adjustment necessary is conveniently given, by only slightly slackening the bolts and striking gentle blows near the end of the slide with a wooden mallet, the end of a tool handle, or even with the side of the clenched hand. The test cylinder is traversed again between every fresh adjustment, until the callipers show it to be of the same diameter at either end; upon which result, a reading point or mark is engraved upon the upper surface of the plate of the lower slide, in a line with the zero of the divisions upon the edge of the circular movement of the upper slide. This reading point, aiding to replace the top slide to turn the cylinder, or to any angle for conical turning.

In the slide rest fig. 146, the top slide is already *square* to the middle slide by construction, while the traverse of the lowest is rendered constant by its cradle, screwed up against the bearers. It is therefore only necessary to adjust the middle upon the lowest slide to turn the true cylinder, to ensure the top slide giving the true surface also. The middle slide is adjusted in the manner already described, and its reading point is then marked on the front edge of the plain lowest slide.

Should greater precision be required than can readily be obtained from the employment of hardwood for the trial surface or cylinder, brass or iron may be substituted for the concluding tests; but, it should not then be forgotten that in turning large surfaces or long cylinders in metal, the edge of the tool suffers an appreciable reduction during the progress of a single cut. This is very visible after a near approximation to an accurate surface has been attained; when it may happen that the surface produced will be either slightly concave or convex, as the tool may have been traversed either

from the center towards the circumference, or in the reverse direction. In testing the cylindrical position, turning the entire length of the cylinder may also sometimes be avoided. A length of about one inch at each end affords ample space for trial with the callipers, and while more expeditious, avoids the risk of apparent error, arising from the wear of the tool, or, from the springing or yielding of the central portion of the cylinder. To lessen the latter, the cylinder should always be of a sufficient diameter to ensure its stability.

SECTION IV.—APPARATUS ADDED TO PLAIN LATHES FOR CUTTING
SCREWS AND SPIRALS. THE SPIRAL APPARATUS. SURFACE
SPIRAL. ATKINSON'S RECIPROCATOR.

The adaptation of the plain lathe to the production of long screws or spirals, has been tried and arranged in many different ways. One early method of copying and varying the pitch of a guide or pattern screw, is shown by fig. 593, page 616, Vol. II., another mode by fig. 594, and others might be cited. The connection of the revolution of the mandrel, with the parallel traverse of the tool in some kind of slide, by means of bands running upon pulleys of relative proportions, has also received many forms; and this arrangement is referred to, as being both early and as still frequently attempted.

The employment of bands and pulleys, has the one advantage of simplicity in the apparatus required, which may be thus roughly described. One band may be led from a small pulley upon the crank, to a pulley of the same diameter upon the mandrel axis, thus making the revolutions of the crank and mandrel equal, or turn for turn. A second band from the largest groove of the foot wheel, may be led to a pulley, say one sixth of that diameter, upon the one end of an overhead shaft, which shaft also carries a second pulley, connected by a third band, with a pulley on the end of the slide rest screw. The second pulley on the shaft being, say, four times the diameter of that upon the screw. These diameters give a velocity of 24 turns of the screw to 1 of the mandrel, and, if the screw be supposed to be of one quarter inch pitch, a spiral of one turn in six inches, or of six inches rise, would result upon the work, about that usually seen upon spiral

balusters. The proportions named may be reduced or exceeded, and if all the pulleys be made with coned grooves, a sufficient variety of pitch may be obtained.

Unfortunately, the practical value of this simple arrangement for producing the spiral, is but little; from the circumstance that the truth of the result is liable to constant interference, either from the elongation, or from the slipping of the bands. The equal tension of the bands, not altogether easily attained from their unequal lengths, is not permanent and is subject to daily variation, both from wear and barometric influence. Elongation may be somewhat mitigated by carrying the bands around adjustable stretching pulleys, or by the use of chains with pins inserted in the pulleys; but these contrivances also have their inconveniences. A less tractable interference with accurate results, lies in the material under operation; variations in its density, disturbing the equal traverse of the tool, hard places retarding the advance of the latter and causing some of the bands to slip. From these disadvantages, screw cutting by connection by bands and graduated pulleys, may be said to be restricted to some few spirals in soft wood; although as will be seen, analogous arrangements are sometimes usefully employed to give a self acting motion to the slide rest, for light cutting in plain turning in both wood and metal.

The foregoing apparatus, when employed for the ornamental spirals of the softwood turner, was usually home made and of the most primitive description, the shaft, pulleys and frequently the slide rest, being constructed of wood. The spirals required no particular accuracy, so long as they were fairly alike, the strands being usually finished by hand, after being cut or roughed out in the lathe. The cutting tool was a drill or revolving cutter, driven by a band from an independent fly wheel.

The more modern arrangement for spiral turning, now generally in use by the balustrade turners, consists of a rough copy of the slide lathe. A main screw of metal, or frequently of wood with the ends in metal sockets, is attached in bearings parallel to, and usually outside the wooden bearers; the latter being sometimes faced with iron plates. The main screw passes through a corresponding tapped hole in a

wooden or metal block, lying on the face, and also embracing the sides of the bearers; a slide for advancing the tool for the depth of cut and the tool carriage, being carried on the upper surface of the block. The mandrel end of the main screw carries a metal toothed wheel and then terminates in a winch handle, by which the apparatus is set in motion. The mandrel also carries a toothed wheel which is connected in gear with that on the screw, by one or more other toothed wheels, used both to vary the pitch, and also as the spiral may be required right or left handed in thread. These wheels are carried upon arbors, fixing in slots in a bracket or a radial arm, attached to the lathe head or to the bearers. The action of these various parts is explained by that of the spiral apparatus in a later portion of this section.

A band passes from the fly wheel of the lathe for driving the overhead motion, a spindle provided with a long drum, from whence a second band, is led to the revolving drill or cutter in the tool carriage. The work is supported against the thrust of the tool by some form of backstay, usually a wooden bar running the whole length of the bearers at about the level of the work, and upon which other narrow pieces of wood are fixed at suitable distances by thumb screws; these pieces having angular notches to bear against the work. Multiplex threads, are obtained by a plain metal chuck, such as fig. 256, which is fitted with a cylindrical wooden stopper, having a central square aperture to carry the end of the square baluster, the opposite end of which is supported by the point of the popit head. The cylindrical edge of the chuck and that of the stopper, are pierced with four and six equidistant holes, a screw pin passing through the one into the other. One strand having been cut upon the work, the pin is removed, and replaced after the stopper has been turned round the required interval within the chuck. The popit head sometimes also has a small power of traverse, transversely to the lathe bearers, to produce the spiral upon shafts of a moderate degree of taper. The wheel on the mandrel can usually be replaced by a division plate, to arrest the work in different positions for plain fluting; the main screw then serves only to traverse the tool. The various portions of these additions to the lathe, are usually of home manufacture, of a rough

and strong character; and it should be remarked, that the spirals as before, generally require to be smoothed and finished by hand.

Various arrangements of bands and pulleys attached to the screw of the slide rest to render the latter partially self acting, are to be met with. A worm wheel with a tangent screw provided with a pulley, driven by a band from the overhead motion, is sometimes attached to the main screw of the slide rest, to obtain a regular traverse of the tool for plain turning and fluting. The band may be thrown off the pulley, or the tangent screw out of gear, when the tool arrives at the end of its traverse; or, the revolution of the fly wheel may be gradually checked and finally brought to rest, at the same moment that the traverse of the tool carriage is arrested by contact with a stop, fixing upon the main slide of the rest or otherwise arranged.

A makeshift mode of communication a self acting or feed motion to the slide rest for plain turning, sometimes used by the engineer, consists of a pin or star wheel fixed upon the end of the screw, having a series of about eight projecting pins. Every time the mandrel revolves, an arm, temporarily fixed at any available position, either on the work itself or on the chuck, comes in contact with one of the pins or points of the star, and moves the wheel and the screw through a corresponding portion of a revolution. A better method is afforded by an eccentric cam fixed to the mandrel, which raises a lever, that is returned to its position by a spiral spring, once in every revolution of the mandrel. A line or chain from the lever passes over two guide pulleys, sliding on a rod suspended from the ceiling of the shop, and descends to a short weighted arm carrying a detent, that engages in a ratchet wheel on the main screw of the slide rest.

More complete apparatus is sometimes employed to give a continuous motion to the slide rest screw of the plain lathe. In one plan, a band from a small wheel upon the lathe crank, drives a short horizontal shaft placed at a little distance behind the bearers, carrying two bevil pinions and possessing a slight power of traverse, so that either pinion, may be made to engage in the opposite sides of a bevil wheel, fixed to the lower

end of a short vertical shaft ; the upper end of which carries a band pulley. From this latter and horizontal pulley, a long band is led around two guide pulleys fixed upon either side, about the center of a second and long vertical shaft ; which shaft is removable, and may be fixed at different positions along the length of, and behind the lathe bearers, so as to regulate the tension. The band passes downwards to two corresponding pulleys attached to a weight, sliding upon this second vertical shaft, and then again upwards, around a third pair of guide pulleys, adjustable vertically upon the upper end of the same shaft, and from thence, to the pulley on the end of the slide rest screw. Placing the one or the other of the bevil pinions in gear, by shifting the horizontal shaft, traverses the tool in the one or other direction.

In an arrangement contrived by the late Charles Holtzapffel, and used in the author's workshops, one band is led from the *mandrel* pulley to two guide pulleys overhead, and then around a plain wheel or band pulley, revolving at a small distance from, and at right angles to the mandrel. This wheel carries a pinion upon its axis, which gears into a similar pinion supported at one side, the whole being mounted together on an eccentric. By this, the revolution may be conducted through the pinion upon the axis of the band wheel, or, through both pinions, to a toothed wheel affixed to the face of a second band pulley, contiguous to the first ; a second band is led from this second pulley, to that affixed to the slide rest screw. The second band, which is also provided with a counterpoise stretching pulley, is reeved over guide pulleys mounted on a jointed swing arm, that traverses horizontally to suit the position of the rest, whether for turning surfaces, cylinders or cones. When one pinion alone is in gear with the toothed wheel, the screw is moved in the one direction, when both are in gear, it is moved in the opposite direction, and in the intermediate position, both pinions may be placed out of gear, when no motion is communicated to the band driving the screw. The change in the direction of the traverse is readily made while the work is in progress, and this arrangement to give a continuous motion to the slide rest screw, although perhaps rather elaborate, has proved both efficient and convenient for plain turning.

THE SPIRAL APPARATUS.

This apparatus, already slightly referred to in the chapter on screw cutting tools in the second volume, connects the revolutions of the mandrel with those of the slide rest screw, by a train of change wheels. It is adapted to plain foot lathes having either back center or traversing mandrels, and affords the screw cutting powers of the ordinary slide or screw-cutting lathe, together with some others. It is perhaps the most convenient arrangement for cutting screws and spirals, not exceeding 8 or 9 inches in length, which length may be said to comprise the whole of the screws required in works executed in the foot lathe. The slide lathe is essential for cutting long screws, and for the execution of large and long plain turning. On the other hand the slide rest apparatus, precisely the same in principle, may be fairly considered to have certain special advantages; in being more compact, less costly, far less laborious in its application, and in permitting the production of the spiral upon surfaces, cones and curved forms. The same apparatus is employed for cutting metal screws with the slide rest fig. 146, and for spirals and ornamental twists in wood and ivory, with the slide rest for ornamental turning. For these reasons therefore, it is very generally adopted in foot lathes by the professional mechanic and by the amateur, and to the latter, it is perhaps the most generally useful addition that can be made to the powers of the plain lathe.

The principle upon which screws of various pitches are produced, as enlarged or reduced copies of a guide screw, by aid of a train of wheels, and also some of the forms taken by the apparatus, have been given in the second volume. It may however be convenient to the reader, to succinctly recal some few points, so far as may appear necessary, in describing the construction of the spiral apparatus and its combinations for different screw threads. The manipulation of the apparatus, will be found in the chapter on screw cutting.

Precisely the same in system and derived from the slide lathe, at first, the details of construction of the spiral apparatus nearly followed the necessary arrangement of the details of the former. The first wheel of the train revolving with the

mandrel, was attached to its back end, fig. 163 ; the last turning with the screw, was carried by a long metal rod, one extremity of which, was connected by a square or fork to the end of the slide rest screw, and the other, supported on a

Fig. 163.

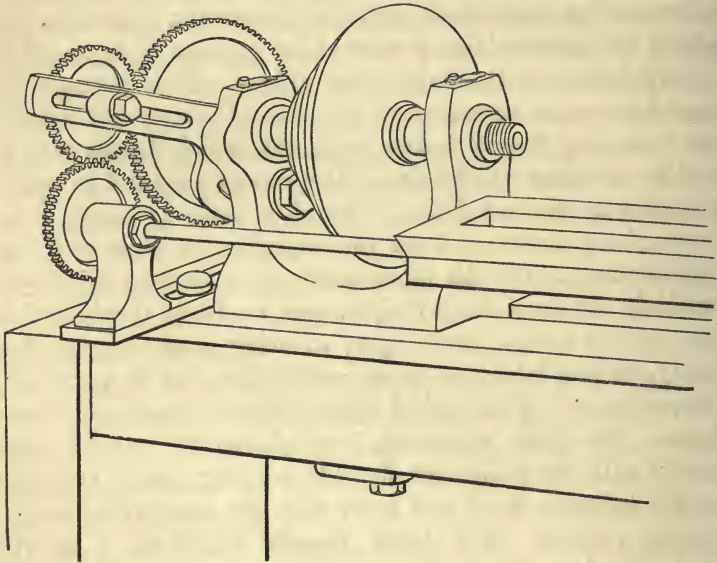

rectangular bracket attached to the bearers behind the lathe head. The intermediate wheels revolved upon arbors, carried by a radial arm circulating around the mandrel, and fixed in position at the back of the lathe head, by a bolt and nut passing through the hole at other times occupied by the pivot of the conducting apparatus of the screw guides.

The apparatus was usually without other means of obtaining multiplex threads, than that of raising the radial arm, to place the wheels out of gear with that on the slide rest screw ; and then, shifting the mandrel or the slide rest screw round through the partial revolution required. This deficiency was sometimes removed, with more or less success, by various forms of shifting carrier plates, carrying the first wheel on the back end of the mandrel, or by shifting the work round within the chuck. The original form of spiral apparatus however proved inconvenient in use ; among other reasons, from the

necessity of every time, removing the conducting apparatus of the screw guides for its attachment; and also, from having to shift the lathe head *forward* upon the bearers to make place for the bracket, by which the pulley no longer stood over the fly wheel. A more serious objection, lay in the use of the rod carrying the last wheel of the train; for unless the rod was adjusted exactly axially with the screw of the slide rest, it interfered with the truth of the thread in every revolution or coil of the screw. The apparatus also, was not suitable to lathes having back centers.

The original form has been replaced by that indicated by fig. 164; in which the last wheel of the train revolves upon the end of the *slide rest screw*; the radial arm is attached to

Fig. 164.

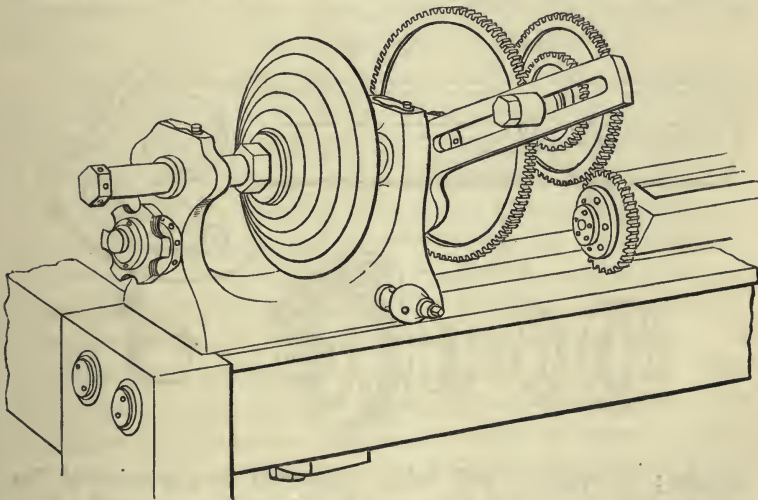

the face of the lathe head, and the first wheel, is carried by a chuck on the nose of the mandrel; the chuck being also arranged for cutting screws of multiplex threads. The modern apparatus being more compact, and free from the objections to which its predecessor was open.

The mechanical details, figs. 165 to 171, comprise the spiral chuck, carrying the work and the first wheel of the train. The radial arm with arbors for the intermediate wheels, with various blanks, nuts and washers, to enable the wheels with

either the large or small apertures to be carried by the arbors. A socket, arranged in the same manner, to carry the wheels on the screw, and a series of about 15 change wheels, usually of brass, with from 15 to 144 engine cut teeth. The larger wheels, are bored out with plain holes, to fit upon the back of the chuck at *a*, fig. 166, to which they are fixed by a screw ring and washer; the smaller, fit only upon the arbors, and upon the socket on the end of the slide rest screw.

The front of the chuck, carries a ratchet wheel of 96 teeth with a detent, by which the *work* is moved round and refixed, one half, third, quarter, or less part of a revolution, in cutting double, triple, or other multiplex threads, without interference with the train of wheels. The ratchet wheel is provided in front with a screw, a copy of the nose of the mandrel, to carry the work, which may be placed in any of the ordinary fixing

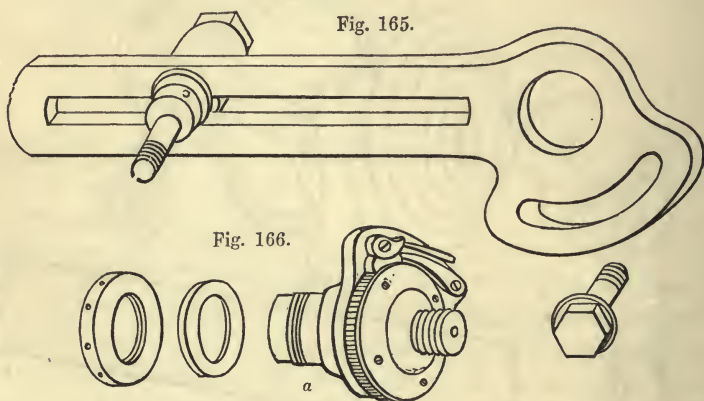

chucks; its opposite end being supported by the point of the popit head. The radial arm fig. 165, is bored out with a hole rather larger than the back of the spiral chuck, and around this hole, on the under surface, not seen in the figure, it has a projecting ring, which fits within a circular recess sunk in the face of the lathe head. The arm moves partially around the mandrel as a center, and is fixed to the lathe head by a screw bolt passing through a circular mortise. The arbors for the intermediate wheels can be placed at any required distance from the mandrel, and are carried on the front side of the radial arm in a long rectangular mortise, in which they are

fixed by screw caps behind. Figs. 167 and 168 give the details of the arbors, their shafts revolve with the wheels, fitting the holes in the smaller and carrying the larger, by blanks or central filling pieces, fig. 169; by which means any single

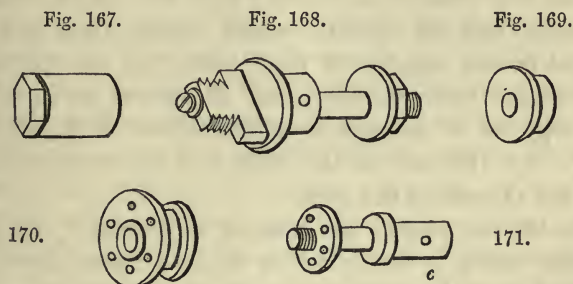

wheel may be employed, or any pair of wheels can be placed together on the same arbor, with either the larger or the smaller of the two, next to the face of the radial arm.

The socket fig. 171, by means of a similar arrangement, fig. 170, carries a wheel with either a large or small central hole, upon the slide rest screw. The cylindrical portion *c*, is received within a circular recess, countersunk in the end of the slide rest, around the extremity of the screw; this portion of the socket is hollowed and accurately fits the plain extremity of the screw, upon which it is retained by a transverse pin passing through them both. The retaining pin is slightly taper, and in length, does not exceed the external diameter of the socket, not to impede the revolution of the latter within the circular recess; a vertical hole bored through the slide rest gives access to the conical pin, which is driven out by a small round punch, when it is desired to separate the socket from the screw. The wheels are carried by the socket instead of directly upon the end of the screw, which in the latter case would have to project, in order that the removal of the socket may leave the end of the slide rest free of any such projection; frequently very necessary in turning, other than screw cutting, to enable the end of the slide rest to be approached close up to the work.

The mandrel carrying the work, and the slide rest screw traversing the tool, revolve at relative speeds, governed by the

diameter or number of teeth, and the arrangement of the wheels connecting them. The rate or pitch of the resulting screw upon the work, being either a copy or a multiple of the slide rest or guide screw, according to the wheels employed. The simplest connection, would be by two wheels, one upon the mandrel and one upon the screw. When these two wheels are equal in the number of their teeth, the mandrel and the screw revolve turn for turn, and the screw produced is an exact copy as to coarseness of the screw of the slide rest, which in fig. 146, and in the slide rest for ornamental turning, is ten threads to the inch.

When the two wheels are unequal in diameter, the pitch of the guide screw is multiplied or divided upon the work, as the wheels may be in the proportion of one to two, one to three, one to four, or otherwise. Thus, taking the first proportion of one to two, when the wheel on the mandrel is twice as *large* as that on the screw, the latter, will make two revolutions to one of the mandrel, and the screw produced upon the work, will contain between every one of its threads twice the space or interval of that of the guide screw, and have five instead of ten threads to the inch. In the opposite case, if the wheel upon the mandrel be half the diameter of that upon the screw, the mandrel will make two revolutions for one of the latter, and the screw resulting will be twice as fine as the guide or copy, and be twenty threads to the inch; and so on for pairs of wheels of other proportions.

The supposed two wheels however are not used alone in practice, for in all probability they would not place the slide rest at a convenient distance from the work; and, they turn in opposite directions. The wheel on the mandrel necessarily turns with the work towards the tool, that on the screw therefore turns in the opposite direction; and if as is usual, the slide rest screw has a right handed thread, the tool travels from left to right, cutting a left handed thread, that is, sloping the reverse way to that of the slide rest and screws in general. When three or any odd number of wheels are in gear, the first and last turn in the same direction, with two or any even number, in opposite directions; a *third* wheel therefore, is interposed between that on the mandrel and that on the screw, to change the direction and produce a right handed thread.

The third wheel employed, is mounted upon a separate arbor or axis, it acts simply as a carrier of motion from the one wheel to the other, and in no way interferes with the results arising from their relative proportions. The third wheel may also be of any diameter or number of teeth, its position may be varied along the straight mortise fig. 165, and its axis may also be raised or lowered by altering the height of the radial arm; so that it may gear with the two wheels, and at the same time accommodate the varying distances, at which it may be convenient to place the slide rest from the axis of the lathe, as required by various diameters of work. In cutting left handed threads, sometimes required, the wheel on the mandrel and that on the screw are also seldom used alone, but, two intermediate wheels are introduced, to give the slide rest freedom of adjustment for distance. Any number of intermediate wheels, so long as *all the wheels of the train are in one plane*, or in other words, drive each other from separate axes, in no respect influence the thread produced by the relative proportions of the wheel on the mandrel and that on the screw.

A considerable variety of threads, both of whole and fractional values, may be obtained from a moderate number of change wheels, more especially if a fair proportion of them be multiples of 6 and 8; the first of the following tables, gives the results obtained from a set of 15 change wheels, with a screw of ten threads to the inch, with one wheel upon the mandrel and one upon the screw. A wheel of any convenient size attached to an extra arbor, being employed for the third or intermediate wheel. If required for any special purpose also, there is little difficulty in adding a change wheel of a suitable number of teeth for producing a required pitch. Thus, a wheel of 53 teeth has been introduced in the table, in order to enable the apparatus to cut a thread of the same pitch as the screws of the mandrels of Holtzapffel & Co.'s 5 inch center lathes; the approximate value of which is stated on page 673, Vol. II., as 9.45. The table shows that 53 on the mandrel and 50 on the screw give a pitch of 9.433 as the result of the combination, which, although not theoretically correct, is a sufficient approximation for practical purposes.

TABLE No. I.

TABLE OF PITCHES PRODUCED BY A SET OF 15 CHANGE WHEELS
WITH MAIN SCREW OF 10 THREADS PER INCH.

Wheel to be placed on the Mandrel in Top Horizontal line.

Wheel to be placed on the Screw in Left Vertical column.

	144	120	96	72	60	53	50	48	36
144		12·	15·	20·	24·	27·16	28·8	30·	40·
120	8·33̄		12·5	16·66̄	20·	22·64	24·	25·	33·33̄
96	6·66̄	8·		13·33̄	16·	18·11	19·2	20·	26·66̄
72	5·	6·	7·5		12·	13·58	14·4	15·	20·
60	4·166̄	5·	6·25	8·33̄	10·	11·32	12·	12·5	16·66̄
53	3·68	4·416̄	5·52	7·361̄	8·833̄		10·6	11·04	14·72
50	3·472̄	4·166̄	5·208	6·944̄	8·33̄	9·433		10·417	13·88
48	3·33̄	4·	5·	6·66̄	8·	9·056	9·6		13·33̄
36	2·5	3·	3·75	5·	6·	6·792	7·2	7·5	
24	1·66̄	2·	2·5	3·33̄	4·	4·528	4·8	5·	6·66̄
20	1·388̄	1·66̄	2·0833̄	2·77̄	3·33̄	3·773	4·	4·166̄	5·55̄
18	1·25	1·5	1·875	2·5	3·	3·396	3·6	3·75	5·
16	1·11̄	1·33̄	1·66̄	2·22̄	2·66̄	3·018	3·2	3·33̄	4·44̄
15	1·0416	1·25	1·5625	2·0833̄	2·5	2·83	3·	3·125	4·166̄

In the foregoing table, every intersection shows the screw resulting from the several combinations; thus,

60 on Mandrel with 60 on Screw gives 10 threads per inch.
 60 " " 15 " " 2½ " "
 36 " " 144 " " 40 " "

In describing the method of attaining screws of any required pitch from a guide or copy screw, by the system of change wheels, page 625, Vol. II., to which the reader is referred; it is stated, *inter alia*, that the value of any combination of wheels may be calculated as vulgar fractions, by multiplying together all the driving wheels as the numerators, and all the driven wheels as denominators, together with the fractional value or pitch of the guide screw. Thus from the foregoing table, neglecting the intermediate wheel altogether, the fraction of the wheels 96 and 48, shows that the screw

resulting, will have an interval of one-fifth of an inch between every thread, or be five threads per inch.

$$\begin{array}{l} \text{Mandrel or driver} \\ \text{Screw or driven} \end{array} \frac{96}{48} \times \frac{1}{10} = \frac{96}{480} = 1|5$$

Any other pair of wheels of the same ratio, two to one, such as 36 and 18, 48 and 24, 60 and 30, 72 and 36, 96 and 48, 144 and 72, etc.; will produce the same result of five threads to the inch. The particular pair selected for use therefore is unimportant, but the choice is influenced by the distance of the rest from the axis of the lathe, which is determined by the diameter of the work and other circumstances. When the position of any of these pairs of wheels is exchanged, the smaller being placed on the mandrel and the larger on the screw, all will in like manner produce a screw having twenty threads to the inch, or twice the number of threads in the guide screw, instead of half the number as previously; analogous results given in the table, arise from the similar employment of single pairs of wheels of other ratios.

The value of the train of wheels is entirely different, when in place of a single wheel, merely to change the direction of the thread produced, the intermediate arbor carries *two* wheels, fixed and *revolving* together, one with the other. These two wheels, cannot both be in one plane with the rest of the train; but one of the pair will be driven by the wheel on the mandrel, and carry the other with it, which latter in turn will drive the wheel on the screw. The results previously obtained, will then be multiplied or divided by the fraction, the value of the pair of wheels on the intermediate arbor. At the same time, as these two wheels turn both together in the *same* direction, they fulfil the purpose of the single wheel previously employed on the intermediate arbor, and cause the thread to be right handed.

Thus, the pair of wheels 20 and 60, in their lowest terms a fraction of one third, when used upon the intermediate arbor, either multiply the previous value of the train by three, making the screw three times as coarse, or divide it by three, making it three times as fine; according to their relative position being $\frac{2}{3}$, or $\frac{6}{2}$, as the one or the other is the driver or the driven wheel. The screw of five threads to the inch, produced

by 96 on the mandrel and 48 on the screw would thus be rendered three times as coarse, or 1.66 by the combination A. and three times as fine or fifteen threads to the inch, by the combination B.

Combination A.			Combination B.		
M.	I.	S.	M.	I.	S.
96	—20		96	—60	
	—			—	
		60—48			20—48

The values calculated as vulgar fractions, with all the driving and all the driven wheels, respectively multiplied together, the fractions reduced to their lowest terms, give

$$A. \frac{2}{1} \times \frac{3}{1} \times \frac{1}{10} = \frac{6}{10} \text{ or } 1.66.$$

$$\frac{2}{3} \times \frac{1}{1} \times \frac{1}{10} = \frac{2}{30} \text{ or } 15.$$

Any other pair of wheels of the same ratio, such as $\frac{1}{4} \frac{6}{8}$ or $\frac{3}{7} \frac{4}{2}$, produce the same result; and the pair of wheels selected for use, as previously explained, again greatly depends upon the diameter of the work, or the space required for the tool, between it and the slide rest. The following pairs of wheels, are used to multiply or divide the terms of the table by 2, 3, 4, etc., and such pairs of wheels as $\frac{4}{8} \frac{8}{6}$ which give $\frac{4}{3}$ ths or $\frac{4}{3}$ ths are employed for fractional numbers.

24 and 48 by 2.
 16 — 48 — 3.
 15 — 60 — 4.
 24 — 120 — 5.

16 and 96 by 6.
 16 — 120 — 7.5.
 15 — 120 — 8.
 16 — 144 — 9.

The finest combination conveniently obtained in this manner, with the set of change wheels specified in the first table; results from interposing the pair of wheels $\frac{1}{15} \frac{9}{5}$ on the intermediate arbor, between 36 on the mandrel and 144 on the screw, the setting given in the table for 40 threads. Which, multiplied by 8 the value of the fraction, results in a screw of 320 threads to the inch upon the work, or a screw so fine as to appear a smooth cylinder.

The following table, gives the combinations of the same set of wheels for screws coarser than half inch pitch or rise. The first screw mentioned, that of half inch pitch, or a rise of $\frac{1}{2}$ ths of an inch in every thread, is produced when the 144 wheel is on the mandrel, gearing into 24 placed on the intermediate arbor, (called also the middle and the double arbor,) which arbor also carries a 60 wheel, that gears into a 72 wheel on the screw of the slide rest. The last and coarsest screw of

this series, has a pitch or rise of 7.2 inches in each revolution; resulting from 144 on the mandrel, working into 16 on the middle arbor, and the 120 also on the middle arbor, working into the pinion of 15 on the slide rest screw.

TABLE No. II.

TABLE OF PITCHES COARSER THAN HALF INCH RISE, PRODUCED BY A SET OF 15 CHANGE WHEELS, WITH MAIN SCREW OF 10 THREADS PER INCH.

Screw produced.	Wheel on Mandrel.	Wheels on Middle Arbor.	Wheel on Screw.	Screw produced.	Wheel on Mandrel.	Wheels on Middle Arbor.	Wheel on Screw.
·5	144	24		2·7	144	16	
		60	72			60	20
·6	144	15		3·	144	36	
		30	48			120	16
·75	144	72		3·2	144	15	
		60	16			60	18
·8	144	15		3·6	144	15	
		30	36			60	16
·9	144	24		3·84	144	30	
		72	48			120	15
1·	144	36		4·	144	24	
		60	24			120	18
1·2	144	15		4·5	144	24	
		60	48			120	16
1·35	144	16		4·8	144	24	
		72	48			120	15
1·5	144	72		5·4	144	20	
		120	16			120	16
1·6	144	15		5·76	144	20	
		60	36			120	15
1·8	144	15		6·	144	18	
		30	16			120	16
2·	144	36		6·4	144	18	
		120	24			120	15
2·25	144	48		7·2	144	16	
		120	16			120	15
2·4	144	15					
		60	24				

The two succeeding tables, give a series of settings for the slide foot lathe, fig. 114, which has a guide screw of 4 threads to the inch; the wheels rising by 5 as usual, from 20 to 120 teeth. The pitches of the screws produced by any of these settings, it is almost needless to repeat, necessarily vary with that of the guide screw employed; therefore with the third and fourth tables, if a guide screw of 2 threads to the inch be employed, it would double the pitches of the resulting screws, while one of eight threads to the inch would halve them, and, so on in proportion.

TABLE No. III.

TABLE OF SETTINGS OF CHANGE WHEELS FOR SLIDE LATHE,
WITH GUIDE SCREW OF 4 THREADS PER INCH.
WHEELS RISING BY 5 FROM 20 TO 120.

DUPLICATES OF 20, 60, AND 100.

Threads per Inch.	Wheel on Mandrel.	Wheels on Arbor.	Wheel on Screw.	Threads per Inch.	Wheel on Mandrel.	Wheels on Arbor.	Wheel on Screw.	Threads per Inch.	Wheel on Mandrel.	Wheels on Arbor.	Wheel on Screw.
1	— 80	— 60	— 20	26	— 20	— 60		65	— 20	— 65	
1 $\frac{1}{4}$	— 80	— 60	— 25			30	— 65			20	— 100
1 $\frac{1}{2}$	— 80	— 60	— 30	27	— 20	— 75		68	— 20	— 80	
1 $\frac{3}{4}$	— 80	— 50	— 35			50	— 90			20	— 85
2	— 80	— 50	— 40	28	— 20	— 60		70	— 20	— 70	
2 $\frac{1}{4}$	— 80	— 40	— 45			30	— 70			20	— 100
2 $\frac{1}{2}$	— 80	— 40	— 50	30	— 20	— 60		72	— 20	— 80	
2 $\frac{3}{4}$	— 80	— 40	— 55			30	— 75			20	— 90
3	— 80	— 40	— 60	32	— 20	— 60		75	— 20	— 75	
3 $\frac{1}{4}$	— 80	— 40	— 65			30	— 80			20	— 100
3 $\frac{1}{2}$	— 80	— 40	— 70	34	— 20	— 60		76	— 20	— 80	
3 $\frac{3}{4}$	— 80	— 40	— 75			30	— 85			20	— 95
4	— 60	— 40	— 60	35	— 20	— 35		80	— 20	— 80	
4 $\frac{1}{2}$	— 40	— 60	— 45			20	— 100			20	— 100
5	— 40	— 60	— 50	36	— 20	— 40		84	— 20	— 80	
5 $\frac{1}{2}$	— 40	— 60	— 55			20	— 90			20	— 105
6	— 40	— 60	— 60	38	— 20	— 40		85	— 20	— 85	
6 $\frac{1}{2}$	— 40	— 60	— 65			20	— 95			20	— 100
7	— 40	— 50	— 70	40	— 20	— 40		88	— 20	— 80	
7 $\frac{1}{2}$	— 40	— 50	— 75			20	— 100			20	— 110
8	— 40	— 50	— 80	42	— 20	— 40		90	— 20	— 90	
8 $\frac{1}{2}$	— 40	— 50	— 85			20	— 105			20	— 100
9	— 40	— 50	— 90	44	— 20	— 40		92	— 20	— 80	
9 $\frac{1}{2}$	— 40	— 50	— 95			20	— 110			20	— 115
10	— 40	— 50	— 100	45	— 20	— 45		95	— 20	— 95	
10 $\frac{1}{2}$	— 40	— 50	— 105			20	— 100			20	— 100
11	— 40	— 50	— 110	46	— 20	— 60		96	— 20	— 80	
11 $\frac{1}{2}$	— 40	— 50	— 115			30	— 115			20	— 120
12	— 30	— 50	— 90	48	— 20	— 80		100	— 20	— 100	
13	— 20	— 50	— 65			20	— 60			20	— 100
14	— 20	— 50	— 70	50	— 20	— 50		105	— 20	— 100	
15	— 20	— 50	— 75			20	— 100			20	— 105
16	— 20	— 50	— 80	52	— 20	— 65		110	— 20	— 100	
17	— 20	— 50	— 85			25	— 100			20	— 110
18	— 20	— 50	— 90	54	— 20	— 75		115	— 20	— 100	
19	— 20	— 40	— 95			25	— 90			20	— 115
20	— 20	— 40	— 100	55	— 20	— 55		120	— 20	— 100	
21	— 20	— 35	— 105			20	— 100			20	— 120
22	— 20	— 30	— 110	56	— 20	— 70		126	— 20	— 105	
23	— 20	— 30	— 115			25	— 100			20	— 120
24	— 20	— 25	— 120	60	— 20	— 60		132	— 20	— 110	
25	— 20	— 50				20	— 100			20	— 120
		40	— 100	64	— 20	— 80		138	— 20	— 115	
						25	— 100			20	— 120

TABLE No. IV.

TABLE OF SETTINGS OF CHANGE WHEELS FOR SLIDE LATHE,
WITH GUIDE SCREW OF 4 THREADS PER INCH.
WHEELS RISING BY 5, FROM 20 TO 120.

DUPLICATES OF 20, 60 AND 100.

Inches Rise.	Wheel on Mandrel	Wheels on Arbor.	Wheel on Screw.	Inches Rise.	Wheel on Mandrel	Wheels on Arbor.	Wheel on Screw.	Inches Rise.	Wheel on Mandrel	Wheels on Arbor.	Wheel on Screw.
Per inch.											
$\frac{1}{8}$	— 40	— 60	— 60	$2\frac{1}{8}$	— 80	— 40		$4\frac{3}{8}$	— 100	— 25	
$\frac{1}{5}$	— 40	— 60	— 50				85 — 20			95 — 20	
$\frac{1}{4}$	— 60	— 40	— 60	$2\frac{1}{4}$	— 80	— 40		5	— 100	— 25	
$\frac{1}{3}$	— 40	— 60	— 30				90 — 20			100 — 20	
$\frac{2}{8}$	— 45	— 60	— 30	$2\frac{3}{8}$	— 80	— 40		$5\frac{1}{4}$	— 120	— 30	
$\frac{1}{2}$	— 60	— 60	— 30				95 — 20			105 — 20	
$\frac{3}{8}$	— 50	— 60	— 20	$2\frac{1}{2}$	— 100	— 30		$5\frac{1}{2}$	— 120	— 30	
$\frac{2}{3}$	— 80	— 50	— 30				60 — 20			110 — 20	
$\frac{3}{4}$	— 60	— 60	— 20	$2\frac{5}{8}$	— 105	— 40		$5\frac{3}{4}$	— 120	— 30	
$\frac{7}{8}$	— 70	— 60	— 20				80 — 20			115 — 20	
1	— 80	— 50	— 20	$2\frac{3}{4}$	— 110	— 40		6	— 120	— 20	
$1\frac{1}{16}$	— 85	— 50	— 20				80 — 20			80 — 20	
$1\frac{1}{8}$	— 90	— 50	— 20	$2\frac{7}{8}$	— 115	— 40		$6\frac{3}{8}$	— 120	— 20	
$1\frac{3}{16}$	— 95	— 50	— 20				80 — 20			85 — 20	
$1\frac{1}{4}$	— 100	— 50	— 20	3	— 80	— 20		$6\frac{1}{2}$	— 120	— 20	
$1\frac{5}{16}$	— 105	— 50	— 20				60 — 20			90 — 20	
$1\frac{3}{8}$	— 110	— 50	— 20	$3\frac{1}{4}$	— 80	— 20		$7\frac{1}{8}$	— 120	— 20	
$1\frac{7}{16}$	— 115	— 50	— 20				65 — 20			95 — 20	
$1\frac{1}{2}$	— 120	— 50	— 20	$3\frac{1}{2}$	— 80	— 20		$7\frac{1}{2}$	— 120	— 20	
$1\frac{5}{8}$	— 80	— 40					70 — 20			100 — 20	
		65 — 20		$3\frac{3}{4}$	— 80	— 20		$7\frac{3}{8}$	— 120	— 20	
$1\frac{3}{4}$	— 80	— 40					75 — 20			105 — 20	
		70 — 20		4	— 100	— 25		$8\frac{1}{4}$	— 120	— 20	
$1\frac{7}{8}$	— 80	— 40					80 — 20			110 — 20	
		75 — 20		$4\frac{1}{4}$	— 100	— 25		$8\frac{3}{8}$	— 120	— 20	
2	— 70	— 35					85 — 20			115 — 20	
		80 — 20		$4\frac{1}{2}$	— 100	— 25					
							90 — 20				

SURFACE SPIRAL.

The pitches of the screws produced by the combinations given in the foregoing tables, may be further extended by the introduction of a second pair of wheels upon one arbor, by which fraction they are again multiplied or divided. With the spiral apparatus, fig. 164, the additional pair of wheels, usually 30 and 60, is introduced at the end of the train, the arbor taking the form of an independent shaft. This particular arrangement of the second double arbor, is adopted to enable the spiral line to be applied to cylinders, for the production of the so-called "Elizabethan Twist," to surfaces, and to cones, and also to surface, cylindrical and tapering curved forms. The coarser spirals thus obtained are generally of multiplex thread, and are principally required for ornamental turning, admitting great variety both in the pitch and in the ornamental section of the thread, which also may be right or left

Fig. 172.

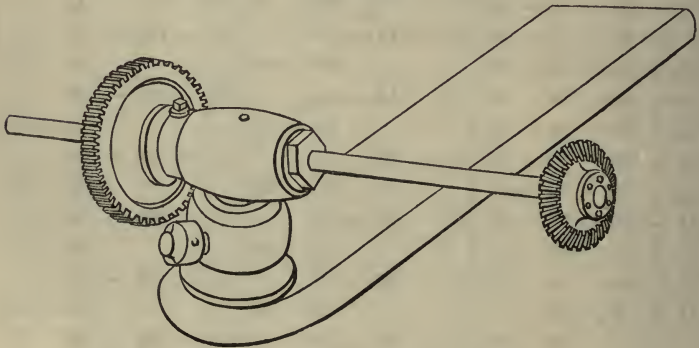

handed. Fig. 180, exhibits the effect of a right handed multiplex surface spiral; both the right and left handed thread are also sometimes cut over the same cylinder, surface or curve, covering these with a highly effective chequered ornamentation. The thread for ornamental purposes is in all cases cut with revolving drills or cutters, with various effect, as these may be used singly or in combination; in the latter case, every strand is traversed consecutively by the one tool, before proceeding to the others employed.

The additional arbor shaft, distinguished as the *Surface spiral* apparatus, fig. 172, consists of a horizontal steel rod about twelve inches long, parallel with the mandrel axis, and sliding through a socket on a vertical stem, carried in a pedestal like a long rest bottom. The parallel base of the pedestal, is fixed, close in front of the lathe head, transversely upon the lathe bearers, by a bolt and nut beneath.

The last wheel of the train, previously placed on the screw of the slide rest, is now placed on the shaft, to the left of the socket fig. 172; while of the fresh pair of wheels introduced, one, is attached to the opposite end of the shaft, and the other is placed upon the slide rest screw; the length of the base, permitting the apparatus sufficient adjustment transversely from the mandrel axis, to accommodate the varying distances required by the diameter of the work, and the length of the

Fig. 173.

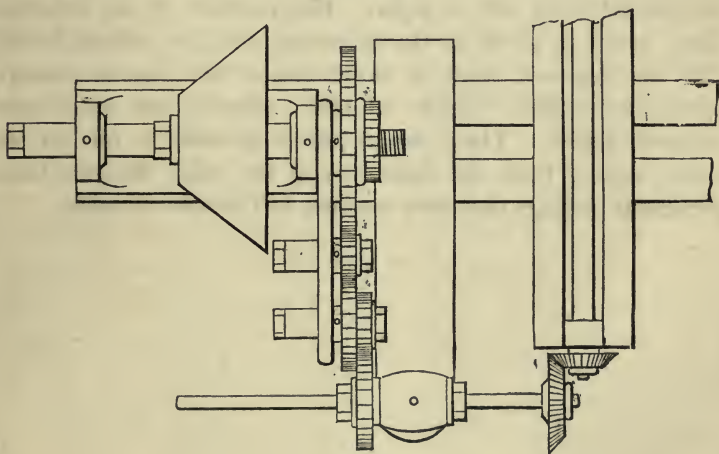

train of wheels employed. The wheel on the end of the shaft, may also be placed close against the right hand side of the socket, or the two wheels may be separated by the full length of the sliding rod; the mandrel therefore may be connected with the slide rest screw at any distance within these limits, required by the length of the work, or the position at which the spiral is to be placed upon it.

To place the spiral upon the surface, the pair of 60 and 30

are made as mitre wheels; the horizontal shaft remains parallel with the mandrel, but the slide rest is placed at right angles to it. The general arrangement of the apparatus being indicated by the diagram in plan, fig. 173. A second pair of wheels with round edges cut into teeth, replace the mitre wheels, to connect the slide rest for all other positions, from that of parallel with the mandrel, to any angle to it, less than the right angle.

The train of wheels employed, is under precisely the same conditions as before, except so far, as they are modified by the fresh pair of wheels 60 and 30. The pitch derived from any particular train, being rendered twice as coarse, when the 60 wheel is placed on the shaft and the 30 wheel on the slide rest screw; or, twice as fine when these positions are reversed. The additional pair of wheels having rendered the number of axes even, giving a left handed screw; a single or intermediate wheel is again required to change the direction of the thread from left to right. The position of the intermediate wheel is given in the following table, in which it will also be observed, that in three cases, two carrier wheels, sometimes called "single or idle" wheels, are used upon separate arbors. These are required in order to fill out the space, arising from the diameters of the other wheels; these particular settings therefore produce left handed threads.

TABLE No. V.

TABLE OF SURFACE SPIRALS COARSER THAN HALF INCH PITCH
OR RISE, PRODUCED BY A SET OF 15 CHANGE WHEELS,
WITH MAIN SCREW OF 10 THREADS PER INCH.

Spiral produced.	Wheel on Mandrel.	Wheel on Single Arbor.	Wheels on Double Arbor.	Wheel on Shaft.	Bevil Wheel on Shaft.	Bevil Wheel on Screw.	Spiral produced.	Wheel on Mandrel.	Wheel on Single Arbor.	Wheels on Double Arbor.	Wheel on Shaft.	Bevil Wheel on Shaft.	Bevil Wheel on Screw.
.5	144	30	48				3.6	144	30	48			
			60	72	60	30				96	16	60	30
.6	144	30	36				4.	144	30	36			
			72	96	60	30				120	24	60	30
.75	144	36-30	16				4.5	144	30	48			
			20	48	60	30				120	16	60	30
.8	144	30	48				4.8	144	24-30	18			
			96	72	60	30				72	24	60	30
.9	144	30	24				5.4	144	24-30	16			
			72	96	60	30				72	24	60	30
1.	144	30	24				6.	144	30	16			
			60	72	60	30				120	36	60	30
1.2	144	30	36				6.4	144	30	24			
			72	48	60	30				96	18	60	30
1.5	144	30	16				7.2	144	30	24			
			60	72	60	30				96	16	60	30
1.6	144	30	24				8.	144	30	24			
			96	72	60	30				120	18	60	30
1.8	144	30	24				9.	144	30	24			
			72	48	60	30				120	16	60	30
2.	144	30	36				9.6	144	30	24			
			120	48	60	30				120	15	60	30
2.4	144	30	18				10.8	144	30	20			
			72	48	60	30				120	16	60	30
2.7	144	30	16				11.52	144	30	20			
			72	48	60	30				120	15	60	30
3.	144	30	16				12.	144	30	16			
			120	72	60	30				120	18	60	30
3.2	144	30	24				14.4	144	30	16			
			96	36	60	30				120	15	60	30

Screws of multiplex threads, right or left handed, have two or more spirals, distinct, and winding around the same axis; they may be cut with all the foregoing combinations. With the spiral apparatus, fig. 164, they are obtained by shifting the *work* round, by the wheel of 96 teeth on the front of the spiral chuck, fig. 166, which serves for the intersection of all multiplex threaded screws, that are its submultiples, viz. 2. 3. 4. 6. 8. 12. 16. 24. 32. 48 and 96. Double threaded screws, have the first thread cut with the wheel fixed at 96, this is then released, the wheel and work turned round and refixed by the detent at 48, retaining the work in position to cut the second thread; for a triple thread, the wheel is placed successively at 96. 32 and 64, one thread being cut at each position and so on.

When the spiral apparatus or the slide lathe, is unprovided with a ratchet wheel; double, triple, or other multiplex threads, are cut by slackening the radial arm, moving it upwards, to place the wheels out of gear, and then, shifting round either the slide rest screw or the mandrel, exactly one half, third, or quarter of a revolution, as may be required. When the mandrel is shifted round, the whole train of wheels, except that on the slide rest screw, or that on the main screw of the slide lathe, moves with it; the wheel on the screw being carefully retained stationary. Should the screw be moved round, the mandrel is then prevented from moving, that none of the other wheels of the train may be displaced by receiving a partial revolution. The radial arm is then replaced and refixed. The teeth in gear of the wheel to be moved, may be previously marked with a piece of chalk, to assist in replacing them, and in counting the teeth to be passed over.

In using any of the foregoing combinations of wheels, described as employed with the spiral apparatus, it should be observed, that the motion is invariably communicated to that end of the train, that moves the more quickly. Thus, in cutting a screw of 50 threads to the inch, the mandrel makes fifty revolutions, while the tool travels over the space of one inch; the apparatus therefore in this case, is set in motion by the mandrel, driven in the ordinary manner by the foot wheel.

A screw of 10 threads to the inch, may be cut when either the mandrel or the slide rest screw, which move at an equal rate, set the work in motion. But screws of half inch pitch, with which the mandrel makes but two revolutions, while the tool travels a distance of one inch, to the extremes of the various coarse spirals employed for ornament; all require the motion to be given through the slide rest screw, turned by its winch handle. The band from the mandrel pulley to the foot wheel is then removed, and the latter is only employed when the overhead motion is required, to drive the revolving drills or cutters used in the slide rest, in cutting ornamental spirals.

ATKINSON'S RECIPROCATOR.

An addition to the spiral apparatus, fig. 174, invented by Mr. G. C. Atkinson of Wylam Hall, Newcastle, converts the spiral into a waved line; various proportions of which may be produced upon the cylinder, cone, surface and upon curved forms. This additional piece is exclusively employed for ornamental turning, and therefore properly belongs to the

Fig. 174.

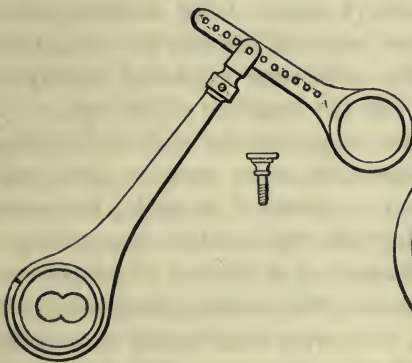
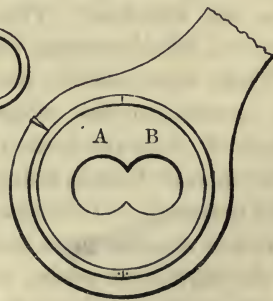

Fig. 175.



succeeding volume; but being an adaptation of the spiral apparatus, it will conduce to uniformity to describe its construction and allude to its capabilities, in this place.

A steel radial arm bored with a hole to fit on the back of the spiral chuck, to which it is securely fixed by the screw ring and washer, replaces the wheel hitherto carried there;

the arm is also bored with a numbered series of small plain holes, placed in a radial line. The other half of the apparatus is a second arm, the lower end of which moves freely around a circular piece of brass, which piece is bored with two eccentric holes, marked A. and B.; the one hole having about twice the eccentricity of the other. The holes A. and B., cut one into the other, but either fits upon the intermediate arbor of the spiral apparatus, upon which it is placed, followed by a wheel; the eccentric of the arm and the wheel, being clamped *together* upon the arbor by its nut and washer. The wheel thus fixed to the eccentric on the intermediate arbor, works into a second wheel carried on the slide rest screw, only these two wheels being employed. The two parts being in position, the end of the second arm is joined to any of the holes in the first, by its terminal fork and a screw pin; when, upon turning the slide rest screw by its winch handle, the two arms communicate a reciprocatory motion to the mandrel, resulting in a waved line upon the work, which is cut by a drill or other revolving tool carried in the slide rest.

The *length* of the wave produced upon the cylinder, is determined by the pair of wheels employed, and is quite independent of the *depth* of the undulation. The latter is varied and determined, by the employment of either of the eccentric holes A. or B., together with the selection of the hole by which the two arms are attached. The undulation produced by any combination, also increases with the diameter of the work.

When equal wheels are employed, the slide rest screw and the eccentric of the reciprocator move turn for turn, and the length of the wave is then one tenth of an inch; ten waves in every inch of length, being also the smallest ornament practically required. If the proportion of the two wheels be varied, as two to one, or three to one, the smaller wheel being placed on the slide rest screw, the screw then makes two, or three, complete turns to one of the eccentric, and the length of the waves becomes respectively, two tenths or three tenths and so on. The set of change wheels previously mentioned, affords an ample variety of pairs in the different proportions, to accommodate the distance of the slide rest from the work; while the radial arm of the spiral apparatus carrying the reciprocator, may be fixed to the lathe head at a greater or less

elevation with the same object. The following pairs of wheels may be employed, viz. :—

Length of wave.	Wheels available.			
2 tenths.	18— 36.	24— 48.	36— 72.	60—120.
3 „	16— 48.	20— 60.	24— 72.	48—144.
4 „	15— 60.	18— 72.	24— 96.	36—144.
6 „	16— 96.	20—120.	24—144.	
7.5 „	16—120.			
8 „	15—120.			
9 „	16—144.			

The flattest curvature for waves of any length, is produced by using the lesser eccentric A., and joining the two arms by the hole at the extreme end, furthest from the chuck, which is numbered *one*; the depth of wave regularly increasing, as the arms are joined closer to the chuck. The greatest undulation follows upon using the greater eccentric B., and joining the arms by the last hole, closest to the chuck. The two lines figs. 176 and 177, in which the length of the wave is similar, indicate the degree of difference between these extremes.

Many varieties in the ornament produced with *Atkinson's reciprocator*, may be obtained by shifting the lines of waves to each other, lengthwise, exactly one half their length, or less, and as a series or consecutively. A series of waved lines having been cut around the cylinder, the work having been turned partially round by the wheel of the spiral chuck for every line; the wave may then be shifted exactly half its length, and then by proceeding again over the same lines, the second series crosses and intersects the first, fig. 178. The ornament indicated by fig. 179, is produced by shifting the line as before, and cutting the second series in the intervals between the first. Shifting the wave half its length, is effected by first slackening and raising the radial arm of the spiral apparatus, to place the wheel on the arbor and that on the screw out of gear, and then leaving the latter undisturbed, by turning the former, which carries the eccentric with it, one half round; after which the wheels are replaced in gear and the arm refixed.

Turning the wheel round precisely one half is rendered certain by an index, suggested by Mr. Francis Barrow, and shown on an enlarged scale fig. 175. Two short lines

distinguishable one from the other by dots, are engraved upon the circular edge of the brass eccentric, at the termination of a diametrical line, at right angles to a line drawn through its center, and those of its two eccentric holes; a fixed reading point, is attached to the upper edge of the arm. Previously to shifting the wave, the screw of the slide rest is turned, until

Fig. 176.

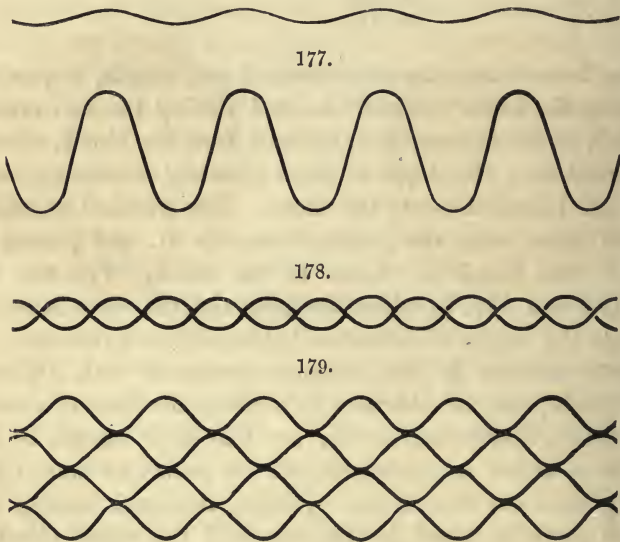

one or other of the marks on the edge of the eccentric, is opposite the reading point; the radial arm of the spiral apparatus is then raised, and the wheel on the arbor turned round until the opposite mark agrees with the reading point, upon which the two wheels are replaced in gear. Placing the two wheels in gear for the *first* cut upon the work, with one of the marks on the eccentric agreeing with the index, when the tool has also been placed opposite its starting point; ensures that the extreme end of the ornament commences with the center of a wave.

The ornamentation resulting from grouping the waved lines, every line shifted consecutively, less than half the length of a wave, is obtained by placing the two wheels out of gear as before, and then, moving round the slide rest screw the

required proportion by its micrometer; taking care that the wheel on the arbor is not disturbed, which also may be observed by the index to the eccentric.

The waved line when placed on the surface, fig. 181, diminishes in its undulations from the circumference to the center; this additional variety in the line, happily showing

Fig. 180.



Fig. 181.



itself in like manner upon all curved solids, the depth of the wave decreasing, as the line travels from the greater to the lesser diameter.

The surface spiral apparatus fig. 172, is required for using the reciprocator upon the surface, upon cones and upon curves having a surface character; the wheel hitherto on the slide rest screw, is then carried upon the left hand side of the socket. The connection with the slide rest screw, being made by the pair of 30 and 60 mitre, or round edged wheels, as before. The arrangement of the apparatus is sufficiently apparent; but the length of the waves obtained by any pair of wheels, is doubled by the fraction of the second pair of wheels introduced by the surface spiral apparatus.

SECTION V.—LIFTING BLOCKS AND LENGTHENING BEARERS.

Works exceptional in their dimensions, either of large diameter or of extreme length, are occasionally required in plain turning. The former are usually of the disc character, and are used for bases, plates, platforms, to which to attach other parts, or wheels, all of which are thin compared with their diameter. Sometimes they consist of pieces having

long projections or arms, such as the pedestal of the hand rest, fig. 102, and other examples to be found in the practical sections; which require additional height for their revolution while some central or other portion is being bored or turned. Many works of large diameter beyond the capacity of the lathe, may be readily accomplished on increasing the height of center, by the use of temporary *lifting blocks*, placed beneath the lathe heads. Works of exceptional length are of exactly the opposite character, being usually of inconsiderable diameter, analogous to long rods; for these, the ordinary foot lathe is extended by the *lengthening bearers*.

A small increase in the height of center, may be obtained by separate parallel slips of metal or wood, placed beneath the lathe head and popit head, on either side of their tenons; the stem of the tee of the hand rest, being raised in its pedestal and fixed at the increased height. Separate lifting pieces,

Fig. 182.

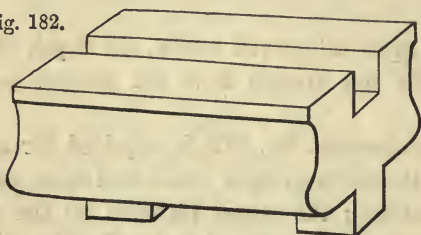

184.



183.

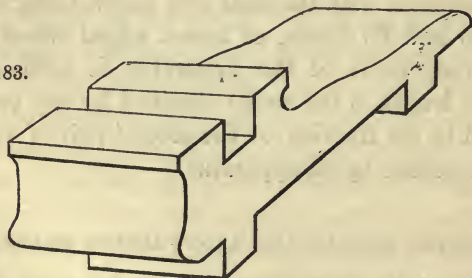

seldom exceed about one inch in thickness, and they should always be sufficiently less than the depth of the tenons, that some portion of the latter, may still be contained between the bearers, to center and give security to the lathe heads. The

lifting blocks employed to give a more considerable increase in height, are made as short lengths of shallow lathe bearers, figs. 182, 183; their upper and under surfaces parallel, with the addition of tenons beneath fitting the interval of the lathe bearers, pierced with holes for the passage of the fixing bolts. The block fig. 182, is employed for the lathe head, and a similar but shorter length mounts the popit head, when that is required to be raised to the same height, to advance the drill in boring, or for the support of the work.

The lifting block for the hand rest, or slide rest, fig. 183, is lengthened out behind and has two tenons, that it may be used to carry the rest, either directly above the lathe bearers, or overhanging them in front. The former is more convenient in turning the center of the surface, and is the more solid position for the tool for internal turning; the latter is required when working towards the circumference of the surface, or upon its periphery. Both the base of the pedestal and the tee of the hand rest, are placed upon fig. 183, parallel with the work, for turning the surface. The pedestal remains in the same position, but the tee is placed parallel with the mandrel, when turning cylindrical edges; the length of the tee, which usually extends beyond the width of the edge being turned, also permitting the tool to be applied to the margins of the upper and under surfaces of the work. Either of the slide rests figs. 145 or 146, may be mounted on fig. 183, upon which they are used in the manner already described.

A longer fixing bolt is required for the lathe head. The bolt of the popit head, usually permanently fixed to it, and the bolts of the different rests, which, like it terminate below in screws, are lengthened by sockets fig. 184, to which their fly nuts and washers are transferred. The lifting blocks used upon five-inch center lathes are about three inches in height, giving the power of turning the light plate-like works described, up to sixteen inches diameter; for which the five inch center lathe is generally abundantly strong. For work falling within their range, lifting blocks are preferable to the gap lathe bearers previously referred to, among other reasons, as they leave the face of the bearers intact, of which the advantages are sufficiently obvious.

LENGTHENING BEARERS.

The bearers of the five inch foot lathes described, are usually from three to three feet six inches in length, but, as a portion of this space is occupied by the lathe heads, the length of work that can be turned between the centers, does not exceed twenty two to twenty four inches. From necessity in the mode of construction, or in the material of turned works, this length is nearly always more than sufficient; on the other hand, the total range of five inch center lathes may be readily extended by the addition of lengthening bearers, to embrace works to about four feet in length.

The most approved forms of lengthening bearers, fig. 185, are of iron, planed and scraped true and parallel, upon their upper and under surfaces; the latter being solid and fixed to the lathe bearers by a tenon and two bolts, permitting longitudinal adjustment, to place the small popit head at about the

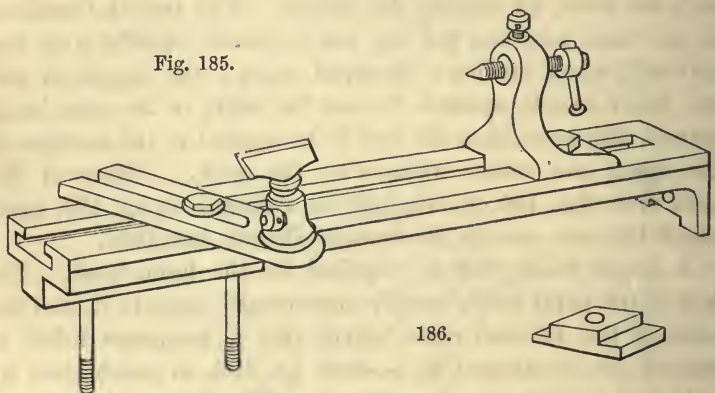

required distance from the lathe head. The popit head and the small hand rest are also adjustable, and are fixed when in position, by bolts screwing into nuts, fig. 186, sliding in a true under cut groove; the ordinary hand rest being used for the support of the tool, in turning that portion of the work situated between the chuck and the front end of the lengthening bearers. No greater length than is requisite to accommodate the work, is allowed to overhang the lathe bearers, and with the same view to avoid vibration, a wooden strut extending to

the floor, is attached by a screw to the inner side of the rectangular projection at the end.

The majority of the shafts and rods for which the lengthening bearers are necessary, seldom exceeds about two inches in diameter; but their length in comparison with the smallness of their diameter, very generally causes the work to be pliable, and to spring away from the turning tool. With the larger works, the piece having been first roughly rounded, the work is supported against the thrust of the tool by the left hand held around it from above, in the manner described in turning soft wood cylinders. Works of smaller dimensions, may be stiffened and checked in their vibrations by the sliding guide fig. 139, or some other support, mounted upon the lathe bearers, and placed about the middle of their length; the hand being still held around and travelling along the work with the tool. A second stay or support is sometimes simultaneously

Fig. 187.

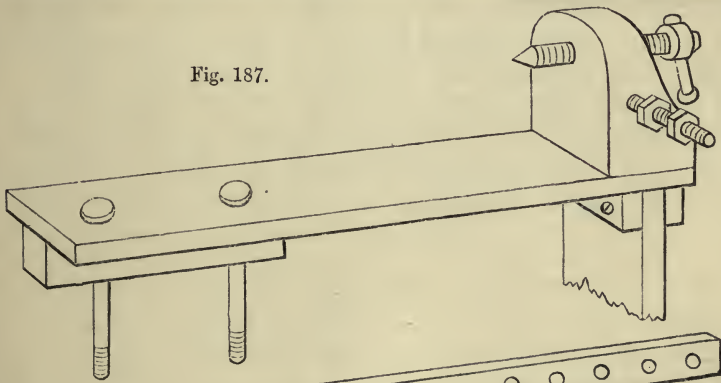
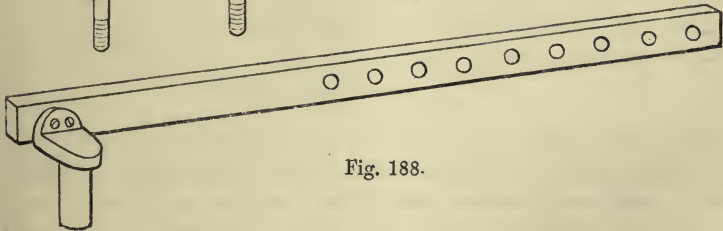

Fig. 188.



mounted upon the lengthening bearers. With very long works, the turning may be assisted, especially when no sliding guide is available, if the work be occasionally changed end for end between the chuck and the popit head. The tool may then always operate upon the half of the work next to the lathe head, which half acquires somewhat less oscillation; and

the small hand rest is then only employed, to support the tool over a short length, joining the two halves, that have both been previously turned from the ordinary hand rest.

A rough method of lengthening the lathe bearers, figs. 187. 188, is sometimes resorted to, and may often be found convenient enough for an occasional purpose. A center screw is carried by a block of wood attached at the end of a piece of strong plank, the latter at the opposite end, having a second piece of wood fixed beneath forming a tenon, which together with two bolts, holds the whole in position on the bearers. A long screw, sometimes adjustable vertically for height, with two or more nuts, projects from the side of the block to support and fix one end of a long wooden bar, forming the tee; the other end of which is attached to an iron stem, clamping in the ordinary rest bottom. A wooden strut should also extend from beneath the popit head end to the floor, to diminish vibration.

CHAPTER VI.

CHUCKS AND APPARATUS FOR FIXING THE VARIOUS WORKS
IN THE LATHE.—◆—
INTRODUCTION.

THE great diversity found in the form, size and materials, of works executed in the lathe, has led to the production of a corresponding variety in the chucks and appliances used for fixing. Necessary to meet the requirements of works that may be long or short, large and heavy, or small and delicate in character; simple or complex in form, and also, as they may be in their first rough or final and finished stages.

Lathe chucks, may nevertheless be divided into two principal groups; the first for long works, those in which the length is several times the diameter; the second for short works, in which the diameter is several times the length. Each of these groups, may be subdivided for convenience of arrangement, viz., into

- Section I. Chucks for long objects supported at both ends.
- „ II. „ „ „ „ at one end.
- „ III. Chucks for short objects, grasped by their edges.
- „ IV. „ „ „ „ fixed against one of their surfaces.

Without attempting the difficult and perhaps unnecessary task, of collecting all the numerous contrivances, that may have been used for every different purpose, the more general and useful of the chucks under each head, will be described; and it will be seen that these comprehend a wider range of work than would probably be required by any one individual or establishment. Many of the chucks are nearly duplicates, while some different forms, apply to the same purposes. These varieties are very valuable, permitting a choice of method of carrying the work; the selection of that most appropriate,

SECTION I.

Chucks for Long Objects supported at both ends; the popit head always required.

PRONG CHUCK . . .	189
FLANGE CHUCK WITH POINTS	190
TAPER FLUTED CHUCK . . .	191

For solid blocks of wood, much used for large and small common works, for toys, and also for preparing material for other chucks.

SQUARE-HOLE CHUCKS . . .	191
--------------------------	-----

For smaller solid pieces of wood, ivory and metal, of less size than the above and squared at one end. Much used in metal, for screws, spindles and other objects in which the centers are not required after completion,—for general purposes and for preparing work for other chucks—Centering and setting the work for the Square-hole and other chucks—Centering tools.

DRIVER OR RUNNING-CENTER CHUCKS . . .	196
VARIOUS CARRIERS USED WITH THE ABOVE . . .	197
CLEMENTS AND OTHER DOUBLE-DRIVER CHUCKS.	200

Extensively and exclusively used for metal works; in which the centers are to be retained—Clements chuck, for the correction of an incidental error.

Scribing tools, and centering works turned from many centers, as cranks, eccentrics—works at right angles.

SECTION II.

Chucks for Long Objects supported at one end; the popit head occasionally used.

SQUARE-HOLE DRILL CHUCK	205
PAD CHUCK	205
BORING BIT CHUCK . . .	206
ROUND-HOLE DRILL CHUCK	206
ARBOR CHUCK FOR CIRCULAR CUTTERS	207

Carrying drills, bits and counter-sinks—for works in wood or metal at rest and advanced by the popit head—for notching joints, screwheads, and for ornamental carving by hand.

HOLLOW CHUCKS WITH PINCHING SCREWS . . .	207
DIE CHUCK WITH TWO SLIDES	208
DIE CHUCK WITH ONE SLIDE	209
BENNETT'S DIE CHUCK . . .	210
MORDAN'S " " . . .	211
BEACH'S " " . . .	212
DIE CHUCK WITH SPLIT DIES	213

Possessing the power of contraction, for short cylindrical and other pieces of wood and metal; assisted by the popit head for long works.

The Screw chucks sometimes of considerable diameter—the Die chucks with slides, have radial adjustment for concentric or eccentric chucking—the Mordan and Beach chucks for wires and drills and small concentric work—Split dies for fixed diameters and arbitrary shapes.

SECTION III.

Chucks for short objects supported by their Edges.

METAL PLAIN, CUP, OR DRIVING CHUCKS . . .	214
WOOD PLAIN CHUCKS . . .	216
WOOD " " WITH METAL SCREWS . . .	216
ARBOR CHUCKS . . .	221

Conical driving chucks without loose parts; for rough pieces of wood rounded with the paring knife or turned circular; the work driven in or upon them by slight blows. The wood chucks turned to the diameter of the work—Arbors, principally metal, for hollow works—Metal chucks filled with wood or lead.

WOOD SPRING CHUCKS . . .	222
METAL " " . . .	223
BENNETT'S " . . .	225
EXPANDING MANDRELS. BRUNELS, HICKS, YUILES, LE COUNTS AND DOUBLE CONE . . .	226

Provided with a small power of central contraction or expansion, for more delicate purposes than the driving chucks. The wood chucks turned to the diameter of the work, the work turned to that of the metal chucks and nearly to that of the arbors.

UNIVERSAL CHUCKS WITH TWO, THREE OR FOUR SLIDES	229
SURFACE CHUCKS WITH DOGS	234

Chucks for wood and metal of various constructions, with considerable power of simultaneous adjustment for contraction and expansion—used for circular objects held from within or without—for square and other pieces—Some chucks with independent adjustment.

SECTION IV.

Chucks for short objects fixed against one of their Surfaces.

STEEL-WORM CHUCKS . . .	236
DOUBLE SCREW CHUCKS . . .	237
ARBOR CHUCKS WITH NUT AND WASHERS . . .	238
ARBOR CHUCKS WITH CONE . . .	238
WILLIS' DISC CHUCK . . .	238

Fixing the work by one central screw—for wood principally plank-ways. For numerous wood, ivory and metal works attached to each other by screws also fitting the screws of the chucks. The Arbor and disc chucks for the completion of works pierced with central apertures.

CEMENT CHUCKS FOR WOOD AND METAL . . .	239
SURFACE CHUCKS FOR WOOD ATTACHED BY SCREWS AND WASHERS . . .	240
SURFACE CHUCKS FOR METAL WITH CLAMPS AND BOLTS . . .	242

Largely used for comparatively thin works in wood and metal,—different methods of centering—Various different methods of attaching works to the surface chucks,—counterpoise to eccentric work.

UPRIGHT WOOD CHUCKS . . .	248
UPRIGHT METAL CHUCKS . . .	251

For rectangular works in wood, ivory and metal—angular varieties concentric and eccentric—Apparatus attached to the metal chuck for analogous larger works. Chucking blocks, used for carrying work at right and other angles to its previous position on the mandrel.

being generally a question either of comparative accuracy or facility. On the other hand, however extensive the collection of chucks, it constantly happens that none are precisely suitable to the work in progress, which, presenting some peculiarity in form, requires either a modification to be made in one of the chucks already possessed, when such occasional alteration presents no difficulty, or otherwise, the construction of a new chuck of a suitable character.

The chucks run absolutely true, only upon the one lathe mandrel upon which they have originally been made; and they do not admit of being changed from one lathe to another, even when the screws of the mandrels are made as nearly as possible to the same size. Should it happen moreover, as is occasionally the case, that one or two chucks out of a series, run nearly equally well upon two different mandrels, the degree of inaccuracy of the remainder, is equally a matter of uncertainty. The want of truth shown by a chuck when placed upon another mandrel, is usually greater and more visible edgewise than upon the surface, and the central point of the chuck, instead of revolving exactly upon itself, revolves describing a small circle, varying according to the degree of error. It is therefore indispensable that all the center chucks pointed or otherwise, and all chucks requiring accuracy, should be fitted and turned true in their place upon their own mandrels; but it will also be observed, that a few of the chucks are always turned out true to fit the work, with these therefore except for appearance, the external want of truth is not of so great importance.

The sets of metal chucks usually vary in number, from about nine to thirty, among which several sizes of the simpler kinds should always be included; the variety or class of chucks and their dimensions, being in accordance with the particular lathe and the purposes to which it is devoted. The chucks enumerated in the foregoing tabulated list apply, some exclusively to wood, others only to metal, while some are employed for either; their names are accompanied by short notes on their general application, with references to matters in connection, which latter, together with the practical use of the different chucks, are described in the four sections of this chapter.

SECTION I.—CHUCKS FOR LONG OBJECTS SUPPORTED AT BOTH ENDS.

These works are fixed, between the chuck on the mandrel at the one end, and the point of the popit head and occasionally the boring collar, at the other. The *Prong chuck*, figs. 189. 190, is used for solid pieces of wood the length way of the grain. The front of the socket screwing upon the mandrel, carries a piece of steel, having a diametrical or other chisel shaped edge, with a prominent central point; these penetrate the wood, the point retains it central, while the chisel edges or prongs carry it round.

The wood is first prepared roughly round with the rasp, hatchet or paring knife fig. 8, Vol. I.; circles scored on the two ends with a pair of compasses, serving as a guide. The one center mark left by the compasses, is placed on the point of the prong chuck, when upon the mandrel, and the wood is driven on to the prong by a few light blows, delivered on its opposite extremity with a light hammer or wooden mallet; the blows being given with very moderate force, both to avoid splitting the wood and also that no undue violence may be

Fig. 189.

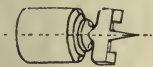
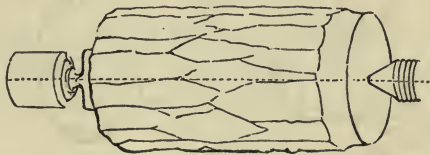

Fig. 190.



conveyed to the mandrel. The popit head, the point of which should but slightly overhang the face of its pedestal, is then brought up to the opposite center mark, fig. 190, and fixed to the bearers; one or two turns given to the screw, causes the point to enter the work, and a drop of oil placed upon it completes the preparation for turning.

Should the wood not be marked with the compasses, its axis is found by trial. The work is very slightly held between the centers, and is made to gently revolve, by hand or by turning the lathe, while a piece of chalk held upon the hand rest, is steadily advanced to the work to detect and *mark* its high points. The left hand is then placed as a support around the

work, while that, is driven *towards* the operator, by slight taps of a hammer given on the prominent parts marked by the chalk, causing the two supporting points to cut their way to fresh centers. The point of the popit head is then slightly advanced, to hold the work in its fresh position; the work is then tested again, and so on until found correct, when the centers are screwed in sufficiently for turning. With but little practice, the work may be adjusted in this manner by the eye alone, and the chalk only used when it is required to obtain the largest possible diameter from the rough material. When the prong chuck is used for the harder woods, it is usual to bore a hole to receive the point, while the hold of the chisel edges may be also much increased, and with less risk of splitting the wood, by a saw-kerf made across the end of the work, or by using a chisel and hammer while the work is held in the vice, to deepen the marks made by the edges of the two prongs.

The steel prong should be permanently fixed in the chuck, and its point turned to run precisely true, when revolving in its place upon the mandrel. The two halves of the chisel

Fig. 191.

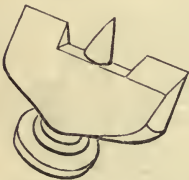

Fig. 192.

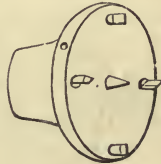

Fig. 193.



edge, frequently diametrical, are better when they are formed out of line fig. 191, with the central portions towards the center point removed; the edges of the prongs are then filed with one upright and one beveled side, these make two separate fissures, not leading into each other, and carry the work round by their vertical faces.

The *Flange chuck with points*, fig. 192, a variety of the prong chuck, is used for work of larger diameter; the point for the center of the work remains as before, but the four separate chisel edges, are placed at a greater distance from the center.

The *Taper fluted chuck*, fig. 193, sometimes replaces the prong chuck, for the first rounding of rough pieces of wood

left from the hatchet, and also for works that admit of being finished at one chucking; as with this chuck, the work cannot be replaced to run true a second time, as on the prong chuck. Fig. 193, is made of metal and has a conical fluted aperture in front; the flutes are about a quarter or three eighths of an inch in diameter, and have an arris, formed by the original cone of the chuck, of about one sixteenth of an inch wide, between each. The rough end of the work catches against and is carried round by the flutes, while the taper of the opening causes the work to seat itself moderately true. For rough and manufacturing purposes, fig. 193, is rapid and convenient, and the work can be chucked in it without stopping

Fig. 194.

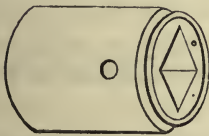

Fig. 195.

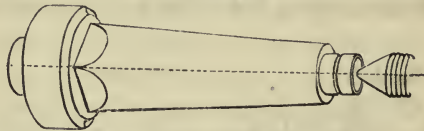
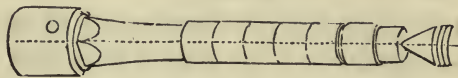

Fig. 196.



the lathe; one end is presented to the chuck while the center of the popit head is advanced into the other, when, it is immediately supported and carried round between the center and the chuck.

The *Square hole chucks*, figs. 194. 195. 196, serve for smaller diameters than the prong and flange chucks, such as pieces of wood for tool handles and other purposes, cut out square by the saw; and for small cylindrical pieces of wood, ivory and metal, the ends of which are roughly squared to fit the chuck, the square aperture of which is slightly taper. The largest of these chucks, used for wood turning, are frequently themselves made of wood, protected by an external iron or brass hoop. Those of medium size, are usually of brass or iron, and the smallest are lined with steel for greater durability.

Pieces of wood left square from the saw, or having the end only roughly squared with the paring knife, merely require the

opposite support of the popit head, Figs. 195. 196 ; affording a rapid and convenient method of chucking, when turning many duplicates. A variety of solid objects in wood and ivory, spindles for circular saws or cutters, and arbors of wood or metal, are chucked in this manner ; fig. 196, is a wooden arbor, carrying a metal tube in process of being cut into ferrules for tool handles. The smaller square hole chucks are extensively used for turning metal screws, spindles and many parts of mechanism, in which it is not necessary to retain the centers of the work after its completion.

Works in metal, require both centering and setting, before they are turned ; that they may at once run moderately truly in the square hole chuck. One end of the rod or forging is

Fig. 197.

Fig. 198.

Fig. 199.



filed square, nearly corresponding to the square in the chuck, the opposite end fig. 198, is then filed flat, and while still in the vice, a steel center punch is driven into the flat end, to indent a slight hollow center for the point of the popit head. The rod is then placed in the lathe, and if its chuck end does not run fairly true, the piece is tried successively in all four positions of the square, that the best may be selected : after which, the side of the work, opposite to the marked side of the chuck, is notched with a file, that it may always be replaced in the same relative position. Should the end of the work not run fairly true in any of the four positions, two of the neighbouring square sides are filed, until the truth of the chuck extremity is sufficiently exact. Subsequently, the opposite end of the work is corrected, or made to run nearly true ; a piece of chalk is held upon the rest as the work revolves, to mark the most prominent part of its circumference. After which the rod is refixed in the vice, the chalk mark towards the operator, and the center punch is placed in the hole, but inclined a little backwards, so that the blow may drive the *center* slightly towards the chalk mark or high side ; this is

followed by another slight blow, given with the center punch held quite vertically over the new center, and the work is then returned to the lathe for examination. The process is repeated as may be necessary, until the chalk mark extends nearly round the circumference.

The two ends being sufficiently true, the work while in revolution, is marked with the chalk at three or four intermediate parts of its length, to show any places at which it may be bent; it is then *removed* from the lathe, and these curvatures are *set* or corrected by the blows of a hammer upon an anvil or other solid substance. Work containing much departure from the truth, has to be corrected by blows when lying across a hollow, such as the open chops of a vice; but, as so large a correction would disturb the truth of the centering, this should be done previously, and the rod rendered nearly straight before it is placed in the lathe. Several screws or other small objects, can be turned successively from off the same piece of metal when carried by the square hole chuck; as each is finished, it is deeply nicked in with the turning tool, that it may be easily broken off, and also to present a smaller spot upon the end of the piece, by which the center is more readily found when it is again filed flat.

The friction of the point of the popit head, gradually enlarges the diameter of the center hole it forms in the work, and this enlargement sometimes takes place more to the one side than to the other, so as thus more or less to interfere with the truth of the axis upon which the work revolves. Want of truth arising from this source, is not materially felt as an evil, in the majority of turned works of wood, nor in many small works in metal; but for the latter it is nevertheless desirable, that the center punch used should be a little more acute than the center of the popit head. When, as in most metal work, the accuracy of the centers is of importance, these are prepared with increasing care. For small works, a fine hole is first drilled a short distance up the axis of the work, in order that the extreme point of the popit head, may not arrive at the bottom of the hollow center; the small deep hole then retains the work fairly well in the axial line, notwithstanding the enlargement that may take place in the upper part of the hollow center.

A fine drill is mounted in a drill chuck and the work, previously centered at both ends, is carried towards it by the point of the popit head; the screw of the latter being turned very gently, to avoid breaking the slender drill. When one end is square as with such pieces as fig. 198, it is a frequent practice to place the work in the chuck, and to use a hand drill, which at the same time pierces and supports the work, with less risk of accident to the drill. The hand rest is fixed at right angles to the bearers, close to the end of the work, and sufficiently high to place the drill at the height of center of the lathe; the drill supported close to its extremity by the fingers, occupying the position of the center punch, fig. 199.

The centers of larger works often require to be prepared with considerable care, while they also fully repay all that may be bestowed upon their accurate formation. Subsequently to boring the axial hole and hollowing the center with the turning tool, the center is finished to the exact form by a taper half round bit fig. 485, or by a countersink of the appropriate angle; the end of the work being generally supported by the boring collar, fig. 128, during these operations.

Centering and setting the work in the manner described, is easily performed after a little practice, but the former process, may be assisted or accomplished by mechanical aids, the simplest and roughest being a pair of spring dividers. The round piece of work is fixed upright in the vice, and the points of the dividers are opened and fastened at a little more than its radius; one point being held against the edge of the work, a line is scratched on the surface with the other; the dividers are then transferred to the opposite side, to scratch a line by the side of the first, after which they are held at right angles to their former positions, to make two other scratches; all of which are quickly made, and the centre is then struck in the interstice formed by the four.

In using the *sliding center*, shown in section fig. 200; the work is also fixed in the vice, the hollow cone is held vertically, resting upon it, while the solid steel cylinder which terminates in a point, is slightly struck into the surface; the mark thus made is strictly central, it is afterwards enlarged with a common center punch and drilled in the manner described. All the parts of fig. 200, being turned in the lathe,

the whole instrument possesses one common center or axis; the work to be centered should be tolerably round, but the tool may also be effectively used upon square and other shapes, care being taken that it is held vertically. The centering tool figs. 201 and 202, contrived by Mr. Kilburn, is founded on the principle, that two tangents being produced, and the angle formed bisected, the line of bisection will pass through the center of the circle, or be its diameter. The instrument consists of a piece of brass, with an angular opening at one end and a handle at the other, a steel plate is attached by screws to the face of the opening, exactly covering one half; the line of its edge bisecting the angle. The round piece to be centered, as before, is placed upright in the vice, and the instrument held in the left hand is applied to the work in two positions; the two lines scribed along the fiducial edge

Fig. 200.

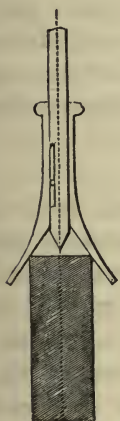

Fig. 201.

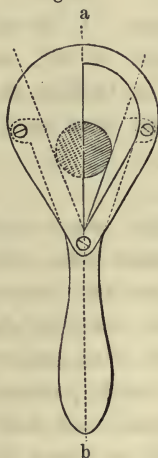
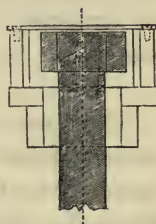

Fig. 202.



a, b, crossing at the exact center. For bolts and other objects with overhanging heads, which are not always forged quite concentric with their shafts and are therefore difficult to center, the bisecting plate is mounted upon three pillars, to raise it a little distance above the angular opening, into which the shaft of the bolt can then enter without interference from its head; in other respects the instruments are alike. The same principle is adopted in a centering tool fig. 203, registered by Mr. Hale in 1862. This instrument, which is

made of stout gunmetal, carries a steel blade, bisecting an angle of 90° , it serves for centering circular and also for mitreing rectangular pieces. The arms of the angle are of precisely the same length that the instrument may also be

Fig. 203.

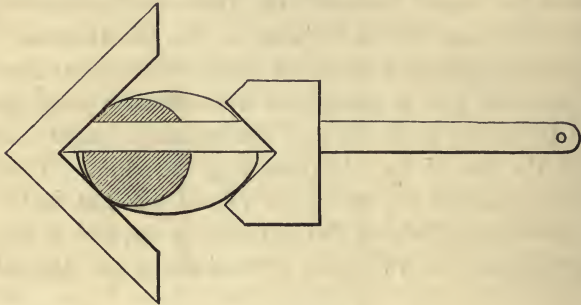

used as a small tee square. A second, but removable gunmetal piece also of the angle of 90° , slides on the steel blade, and is intended to assist in finding the centers of ellipses, or of irregular shaped pieces that may be held between the angles.

The *Driver or Running center chuck*, figs. 204. 206., is derived from the dead center lathe, which it resembles in the suspension of the work, but the center is now rotatory and gives the distinctive name to the chuck. The motion is transmitted by the contact of an arm or pin, *the driver*, on the chuck, with an arm or *carrier*, attached to the work; the latter, having been previously set and centered at each end. The running center chucks in some of their numerous varieties, are used for chucking nearly all the rods, spindles and long objects, that occur in metal turning and machinery.

Running center chucks for foot lathes are made of two principal forms; fig. 204, has a steel conical center screwed in the front, and the driving arm, carried in a rectangular mortise provided with a fixing screw, for its adjustment to the diameter of the work; the arm is sometimes made in two pieces, to be capable of elongation in both directions. The other form, fig. 206, is stronger; the center point is screwed into a flat

plate, which also carries the cylindrical pin or driving arm. Two or three holes may be tapped into the plate, to vary the distance of the pin from the center, or that, may be made with a collar, nut and washer, fig. 207, to fix in a radial mortise; occasionally it is made as a fork, fig. 208, and also of some other forms. The short straight driving pin is stronger, both in form and position, than the rectangular arm fig. 204, which is sometimes distorted by use; while its power is greater, from the increased distance at which it can be placed from the center. In large power lathes, in which the diameter of the

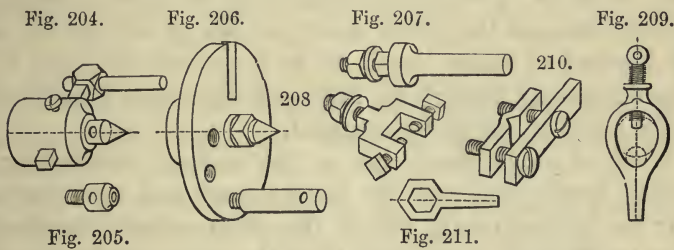

nose of the mandrel is considerable, the running center point and the driving chuck are usually separated. The center is made with a long, slightly conical stem, fitted into a deep taper hole in the end of the mandrel, which extends back, beyond the front upright of the lathe head and terminates in a transverse mortise; the shaft of the center fitting within the hole, in exactly the same manner as the drills are fitted to the round hole drill chuck, fig. 235. The one center is used with two or three driving chucks of different dimensions, and the arrangement has the advantage of not extending the running center much beyond the end of the lathe mandrel.

The *carriers* attached to the end of the work to sustain the thrust of the pin or driver, are made of still greater variety. In forgings, a projection is very frequently left upon the solid to catch against the driver, fig. 466, and is cut off when the work is finished. The *Heart carrier*, fig. 209, has a single screw to attach it to the work, and a tail to catch against the driver; it is suitable to round pieces of various diameters, as shown by the dotted lines. The screw binds directly upon the rough forging or casting; a piece of thin sheet brass being bent around the ends of more finished work, to preserve that

from injury. The heart carrier may also be used for square rods, but these are more efficiently carried by fig. 210, with two bars and two side screws. Many carriers are made as fig. 211, with square, oblong or hexagonal holes, for the heads of screw bolts or similar pieces; a side screw being sometimes added to assist their attachment to the work. Similar carriers, having round holes tapped with corresponding threads, are used upon the ends of screws, which would be injured if gripped in figs. 209 or 210. The *Screw carrier* is sometimes retained by a nut, the carrier and nut being screwed against each other in opposite directions; but it is more usual, to slightly disfigure the thread upon one face of the carrier, with the hammer or center punch, so as to prevent the screw from passing entirely through the hole, and the carrier from turning round upon the object to be turned.

Want of equilibrium, due to the unequal distribution of weight, in the work and the heart shaped and other carriers, may be inconveniently felt in the effect called "backlash." Directly the tool is removed from the work, the carrier falls away from contact with the driver, and rambles backwards and forwards, crossing the centers of the lathe during revolution; and, on replacing the tool, the driving contact is taken up with a jerk, which is injurious to the work and also liable to damage the cutting edge of the tool. The backlash is considerably diminished by attaching the driver to the carrier; this may be done by binding them together with wire, or by some mechanical arrangement, of which the forked driver fig. 208, is an example; but even when so attached, the contact between the carrier and the driver will still always vary, when the tool is off and when it is on the work.

The *Ring carrier* with four screws fig. 212, serves for cylindrical works of a large range in diameter, the circular form ensures its equilibrium, and the driving pin, which is fixed to the carrier and loosely fits a narrow slit in the chuck, reduces the oscillations of the backlash to a minimum. The driver chucks are frequently provided with an interchangeable hollow center, fig. 205, for occasional use for works pointed at both extremities; but, if the hollow center be often required, it is preferable to have *distinct* chucks, to avoid the deterioration in the truth of the centers, caused by frequent removal.

The revolution of the pointed center supporting the work, introduces a liability to error, arising from wear and other circumstances, which may prevent the center from being precisely concentric with the axis of the lathe; the same amount of error is then transferred to the work, and a cylinder turned

Fig. 212.

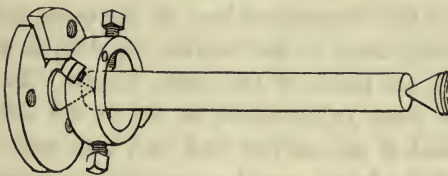

in such case is not perfectly true or concentric with its axis of rotation. The dead center lathe, in which, while the work revolves the center remains at rest, is necessarily free from this error of eccentricity, and it is still therefore frequently resorted to, for works requiring considerable accuracy.

The difficulty experienced in turning a cylinder of the highest attainable accuracy, also arises from many other causes, besides that of want of positive truth in revolving centers; elasticity, interferes in various ways, and in addition,

Fig. 213.

Fig. 214.

Fig. 215.

Fig. 216.

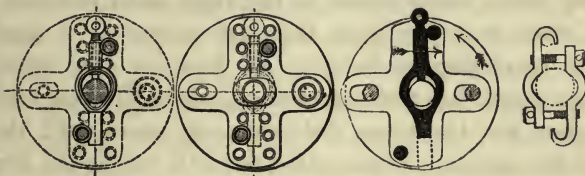

the resistance the work offers to the tool, and the strain caused by the contact of the carrier with the driver, tend to twist the work between them and to place its surface slightly out of truth. Mr. Clement contrived a driving chuck, in which two points of contact exert equal and opposite force upon the carrier, which materially diminishes any error arising from torsion.

The *Double-self acting driver chuck* of Mr. Clement, is shown dotted with the carrier in outline in fig. 213; with the carrier

dotted in fig. 214, and also by fig. 215, a diagram to explain the action of the chuck. The chuck as before, consists of a round plate or flange with a steel pointed center, having in addition a strong plate in the form of a cross, sliding diametrically upon its face, where it is retained by two fixed studs, shaded in fig. 215. Two driving pins are used, inserted in any two of the several pairs of holes, tapped at the same distance on either side of the diametrical line of the cross plate; and the two ends of the heart or bar carrier fig. 216, or any other that may be used, are made of the same length. In the diagram fig. 215, the plate is traversed as far to the left as the studs will allow, and if the carrier had only one arm, as usual, the revolution of the lathe, would convey the resistance to the tool through the carrier to the upper pin; this, being fixed in a

Fig. 217.

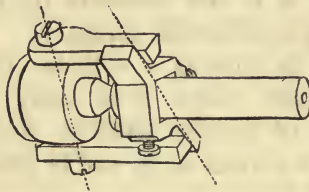
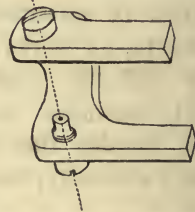

Fig. 218.



yielding slide, would travel to the right until checked by the studs, when it would drive the work round by a single pin, without correction as before. As however the carrier used with the chuck has two equal arms, when the one end meets the upper pin, the cross slide can only move until the other end of the carrier, shown dotted fig. 215, meets the lower pin, when the two pins serve as equal points of resistance to each other, conveying equal and opposite forces to each end of the carrier. To prevent backlash, a third pin is placed in the cross piece and loosely retains one end of the heart carrier as in a fork; the hooked extremities of the bar carrier fig. 216, embrace the pins, and serve the same purpose.

The double driver chuck fig. 217, has been made after several different forms, but all having the common feature of the two driving pins connected together, moving as one piece on pivots placed diametrically across the chuck. The driver and

pivots, which in this particular form of the chuck admit of only one radial distance, are shown separately by fig. 218. Less efficient than Clement's double driver chuck, they are also comparatively weaker, in the same degree that fig. 204, is to fig. 206; the general forms of which, these chucks may be considered to follow.

The work hitherto referred to as mounted between centers, has been concentric; but portions are frequently required to be turned eccentric to the general axis, and either parallel with, or at various angles to it, when two or more pairs of centers become necessary.

When the eccentricity is parallel to the axis and is also sufficiently small, as in the crank fig. 219, the two pairs of

Fig. 219.



centers are made in the object itself; the centers 1—1, serve for the principal and concentric portion of the solid, and the centers 2—2, for turning the eccentric or crank. It is however essential, that the four centres should be in one plane and their relative distances equal, otherwise the two axial lines of the crank will be oblique instead of parallel; the effect of any such obliquity being doubled, by the crank rod or hook oscillating twice as much as the angle of error, causing wear and straining of the parts of the mechanism. To correctly set out these centers, fig. 219, should be laid at rest in a fixed horizontal position upon a true plane surface, such as fig. 868, Vol. II., while a line is marked at each end, passing through the centers 1—2, the same height from and parallel with the surface; after which, it only remains to mark the centers upon these lines with the linear distance exactly alike between each pair. Work of irregular or curved form is supported on the surface plate by blocks of wood or metal, placed beneath any projecting or raised portions and so arranged, as neither to interfere in scribing the lines nor to raise the work from taking its fair bearing on the surface plate.

The *Scribing Tool*, one form of which is given by fig. 220, is held in the right hand, pressed down and sliding upon the surface plate, while the point, which may be fixed at any height, traces lines upon the work exactly parallel with the base that lies upon the surface. Similar and equal lines may thus be extended around all sides of the work, as base lines upon which to set out subsequent measures, and all such lines so scribed necessarily lie in one plane, whether parallel with, or at angles to each other. The purpose of fig. 220, is occasionally fulfilled, but in a much less exact manner, by a pair of spring dividers, one point of which is allowed to rest upon the surface the other scribing the work. Should the edges or ends of the work, have been made rectangular in the planing machine or otherwise, the surface plate may frequently be

Fig. 220.

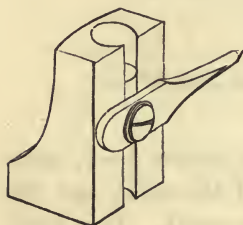
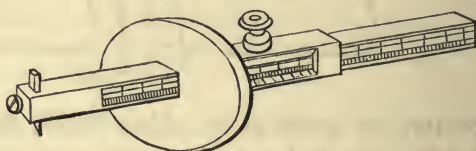

Fig. 221.



dispensed with, as the lines can then be marked with the gage fig. 221; this instrument resembles the joiner's marking gage more exactly made in metal, the head, which traverses the work, being faced with steel and fixed with a set screw. Scales at the side, usually one of eighths and thirty seconds and another of tenths, with vernier to read to hundredths, determine the distances of the head from the cutter.

The centering of larger and more complex work, is illustrated by the double throw crank, fig. 222. The central and end portions of the shaft, are turned upon the centers 1—1; and exactly to fit the round holes made in the two cast iron arms A. A., which are then bolted on the shaft to carry the centers for turning the two crank necks external to its axis; they also carry counterpoises, to give the whole mass a near approach to equilibrium. The centers for the eccentric axes, having been previously made in each arm, at one common

distance from the central holes by which they are attached to the shaft, and also at one common distance from their edges ; it is only necessary when fixing them, to place the two pieces in the required direction and then "out of winding," by trying the whole collected mass upon a surface plate. In heavy work of this character, the simple method employed by the joiner and others, page 500, Vol. II., that of looking along the work from end to end and adjusting the edges of the two pieces to

Fig. 222.

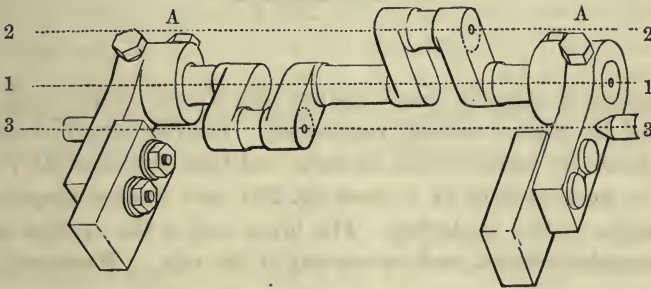

parallelism, would be preferred and practised. The one neck having been turned, the arms are shifted to a new position at right angles to the former, and the second neck is then turned from the centers 3—3. The centering pieces may include two or more pairs of centers, to turn several cranks of similar or dissimilar radii upon the same shaft, and the relative distances once carefully set out, any number of pieces may be turned exactly alike, and in strict accordance with assigned measures. When necessary to prevent the work yielding, from the compression of the supporting centers, or from weakness due to its form, wooden or metal stays are placed and clamped between the parts, so as to complete the line temporarily used as the axis of rotation.

Forms such as those indicated by the diagram, figs. 223. 224, in which the parts are at one or more angles to each other, require projections to be left in the solid material, or to be temporarily attached to the work, for placing one or both centers obliquely. This is practised in turning the legs and backs of chairs, the curved portions of harps and other crooked objects. By working from many centers the piece will assume

a polygonal figure, and if the changes be small and frequently repeated, it may be turned so as very nearly to approach a curve. Such works however have so little stability, that it is

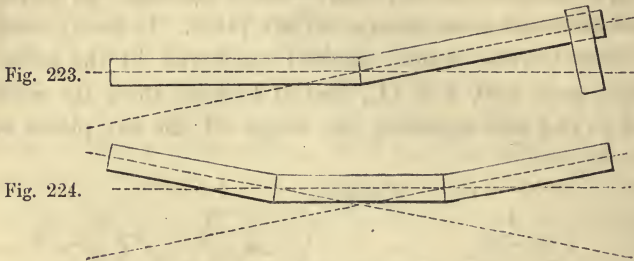

necessary to support them against the thrust of the tool, by one of the guides already mentioned. Similar forms in metal are generally turned while straight and bent subsequently.

The back upright of a chair fig. 228, and similar shapes are examples of this centering. The lower end of the upright is of rectangular section, and curves out of the axis. When cut out

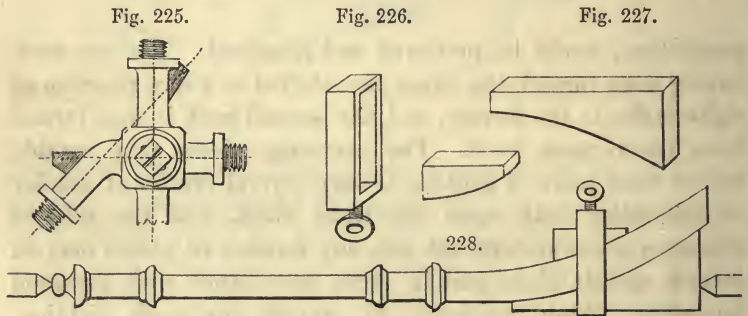

to shape with the saw, the work is mounted in the lathe to turn the straight portion, and is centered by means of flat wedge shaped pieces of wood placed upon either side, and retained in position by an iron screw clamp, fig. 226, which passes around the whole.

The four way tap fig. 225, is offered as an indication of the general method of turning from several centers. This particular object would be mounted successively upon the three axes shown by the dotted lines; the two shaded projections being cast upon the solid, to afford a place for the centers external

to the work, such pieces being usually removed by the saw, or chisel and file, after the completion of the turning. The lines for the centers would be traced with the scribe and surface plate, as already described, to place them all, either in one or in parallel planes as required.

SECTION II.—LONG OBJECTS SUPPORTED AT ONE END ONLY.

The chucks for carrying drills are constructed in a variety of forms; the most simple, fig. 229, has a square hole of much greater length and less angle, than the similar chuck employed for turning. The shank of the drill, fig. 476, Vol. II., is filed square and taper to exactly fit the hole, and both drill and chuck are marked, that they may always be replaced in the same relative positions. The aperture of fig. 229, is sometimes

Fig. 229.



Fig. 230.



Fig. 231.

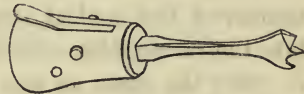

Fig. 232.

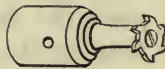

Fig. 233.

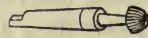

Fig. 234.

made of the same size as that of the pad or socket of the carpenter's brace, that it may carry the same set of bits for works in wood, and when the chuck is provided with a spring catch to retain them, fig. 231, it is called a *pad chuck*.

The stems of the ordinary brace bits are usually not very exact either in size or straightness; qualities that are not essential to their use in the brace, in which the guide for revolution is the point of the tool itself. In the lathe on the other hand, the bit acquires the exact revolution of the mandrel, imparted through its opposite extremity or butt end, and inaccuracy of fit in the chuck, or of truth in the stem, is at once felt at the point of the tool, which then cuts imperfectly because it describes a small circle instead of revolving truly upon itself. All the brace bits therefore, to obtain truth for their revolution in the lathe, require their stems to be "set"

with a hammer, after the manner already described. The bits have greatly increased stability and are preferable, when each is permanently fixed in a separate *Boring Bit chuck* fig. 232.

The *Round hole drill chuck* fig. 230, enlarged views of which are given by figs. 235 and 237, attains both truth and security, the fittings for both the chuck and the drill are made in the lathe. The hole made in the steel socket for the stem of the drill, fig. 235, is slightly conical, and a diametrical mortise of less width than the bottom of this hole, is pierced through the

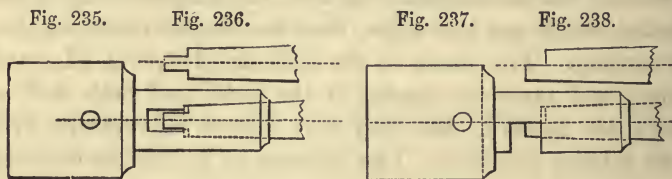

socket, just beyond it. Two flat sides are filed at the extremity of the conical stem of the drill, and allow it to pass into the rectangular mortise which gives the revolution; being in effect the same as two sides of the square hole chuck, but the exact agreement is no longer necessary, as the concentric turned portions place the drill in the true axial line. To ensure this, the flats on the drill should be of rather more than sufficient length, so as to slightly enter the conical hole as shown, that the corner or shoulder may not interfere with the round stem taking its true bearing. Figs. 237. 238, are a different form, in which a notch is filed down to the diametrical line in the drill socket, the end of the drill being shaped to correspond. A side screw is sometimes added to the socket, to prevent the drills being withdrawn from the chuck by becoming clogged and remaining fast in the work, a notch being filed in the drill to receive the point of the binding screw. The drills are released from the chucks by a lever or wedge, inserted in the mortise or notch beneath the end of the tool.

The *Arbor chuck for circular cutters*, figs. 233. 234, may be mentioned here, as being allied to the drill chucks; it carries small circular saws and cutters fitted and attached by a screw, to the extreme end of a solid steel arbor; this may be permanently fixed in the chuck, or several such arbors may be

fitted to either of the chucks figs. 235 or 237. The small saws are employed by the optician and others, for notching the heads of screws, making knuckle joints and for a variety of purposes, as described fig. 730, page 753, Vol. II. The circular cutters with edges of various sections, and generally of very small diameter, are used for some kinds of rough carving in wood and ivory; the heads of sticks and parasol handles are frequently ornamented in this manner, the work being held against the revolving tool by the hand alone, the better specimens being subsequently finished with carving tools.

A large proportion of works of moderate length, both in wood and metal turning, are supported at one end only; many of these are conveniently carried by chucks having movable parts, usually screws, or dies advanced by screws. The *Hollow chucks* with pinching screws, are strong and simple, and are

Fig. 239.

Fig. 240.

Fig. 241.

Fig. 243.

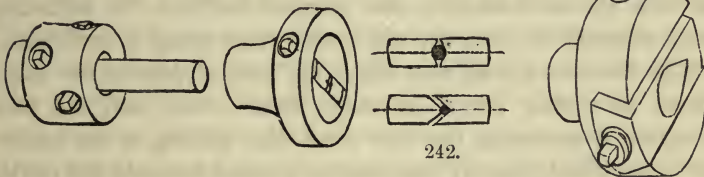

242.

employed both for large and small works. The *Die chucks*, which present great variety in construction, are more applicable to works of small dimensions; some, only to round pieces such as drills and small wires.

The *Hollow screw chuck*, fig. 239, is a strong ring of brass of about an inch internal diameter, having three radial screws in one plane, and in another plane about one inch behind, three other radial screws placed intermediately to the first. In adjusting the work to run true, it is first lightly held by the three front screws, the three back screws being unemployd, and allowed to remain just out of contact. The high side of the work, or that most distant from the center, having been observed by the eye or marked with a piece of chalk, while in revolution, the hand is placed around the work to hold it,

while the two screws upon the low side are slightly slackened and that on the high side equally advanced. The effect produced having been observed, the correction is repeated until the end of the work next to the chuck is found to run true. During this operation which may be rapidly effected, the opposite end of the work, that most distant from the chuck, may also be rendered fairly true, either by pressure of the fingers or by light taps with a hammer; it may then be more correctly adjusted by means of the second three screws, now brought into use and advanced or withdrawn after the same manner as the first. When the work is satisfactorily adjusted to truth, all six screws hitherto only in light contact, each receive a trifling further advance to strengthen the grasp. Larger screw chucks made in the shape of a cup or bell are employed by the engineer, frequently for works of considerable size, but generally of far less proportionate length than those considered in this section. The radial pinching screws of these larger chucks are sometimes placed all in one plane, and when in two planes, they are more usually eight in number; the six screws however, offer greater facilities for adjusting work of moderate size, for which also their grasp is sufficient.

The *Die chuck with two slides* fig. 240, employed for small pieces of metal, ivory or wood, from about half an inch diameter downwards, has two steel dies sliding in an undercut diametrical groove; the dies are pushed towards the center by two screws, working in a strong surrounding ring, solidly attached to the chuck. The one or the other die is advanced or withdrawn to adjust the work to center; the formation of the jaws or faces of the dies, preventing the piece chucked from escaping the central line of the slide in the other direction. Both dies are usually filed to an internal angle of about 120° , fig. 241, and serve to grasp round, square and other shaped pieces; sometimes as in fig. 242, the one has an internal and the other an external angle of 90° , the sharp corner of the latter being slightly removed, these dies are suitable for very small diameters.

Straight pieces are readily adjusted to centrality in fig. 240, while the independent action of the dies, permits a slightly eccentric chucking when required. By this very necessary and convenient property, work that is not quite straight, can

be adjusted sufficiently near to the axis of the lathe for turning, so that for short pieces the operation of setting can frequently be dispensed with. Thus, the square jaws fig. 241, may be used to grasp the tang of the brace bit, before alluded to, and will give a sufficient eccentricity to the butt end, to compensate the want of straightness in the stem and to cause the point to run truly. The bit or the work while in process of adjustment, is twisted round to different positions within the square, to find its greatest eccentricity, which should be placed in the direction of the slide.

The *Die chuck with one slide* fig. 243, has two binding screws, one of which secures the work in the angular opening of a diametrical slide, that is fixed in position by the other. The work is first fixed in the slide, which is set to move rather stiffly by its binding screw, the slide is then adjusted to exactly center the work, by a few light blows upon its ends, given with a mallet or the end of a tool handle, after which the binding screw of the slide is finally tightened.

Both the chucks figs. 240 and 243, when once adjusted, may be employed for turning a succession of pieces of *one* diameter; the first, by releasing only one of the dies and the second, by leaving the side screw undisturbed. Fig. 243, with or without the popit head according to the length and size of the work, is very serviceable in turning moderate sized pieces having more than one axis, such as the crank fig. 219; the slide moves the work the distance between the different centers, and as the work is not released during the change of center given by the slide, the parallelism of the turned parts is ensured.

The *Die chuck* figs. 244. 245, contrived by Mr. Isaac Bennett, has but one screw, both to fix its diametrical slide and to grasp the work. The latter is carried in an angular opening of 90° , and may be of any size from rather more than an inch in diameter downwards; the chuck has great power and sufficient range for most small works, and applies with equal facility to other sections besides the round. The slide moves freely in double chamfers formed in the two sides of the chuck, which are strengthened and secured to each other by a strong steel ring attached in front. The angular portion of the opening to carry the work is lined with hardened steel, the opposite end of the slide is bored with a hole exactly

through its center line, tapped to receive a short and strong steel screw, and the entire slide is also divided longitudinally through the same line into halves. The screw is without a head, so that except by encountering the work, it could be

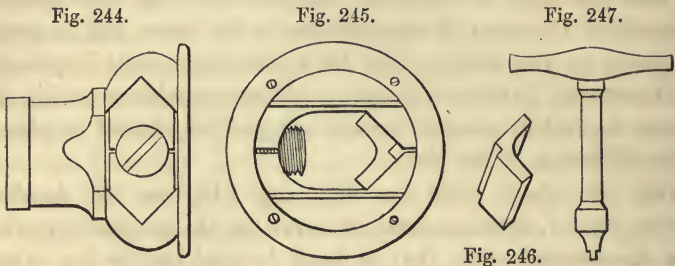

screwed completely through into the angular opening; it presses the work towards the apex of the angle, where the work, bearing equally against the two angular sides of the slide, forces them equally outwards, fixing them against the sides of the chuck at the same moment that it is itself fixed in the angle by the screw.

For works of smaller diameters, the size of the opening is contracted by a rectangular hardened steel filling piece, shown in the chuck and also detached fig. 246. The limbs and ends of this are filed exactly to 90° , so that it can be inserted in the slide with either its wider or smaller opening facing the screw, to diminish the opening according to the diameter of the work; the pressure being then conveyed through the work and the filling piece, to the two halves of the slide as before. Besides extending the range, the filling piece causes the slide to remain always so nearly central, that the chuck is always virtually in equilibrium upon whatever diameter of work it may be employed; it is retained in the slide, and the slide in the chuck, by steel springs to prevent accidental displacement.

For adjustment to center, the work is first lightly held by the screw, while the slide is brought into position by the hand, or by light taps with the end of the handle of the turning tool, delivered upon the end opposite the screw; a half turn is then given to the screw with the key fig. 247 which fixes the work and the slide. If the work has not been "set," when the

slide has been first roughly adjusted, the screw is slackened, and the work is twisted round by the fingers, to find the position in which it runs most nearly true; a more careful adjustment being then given to the slide before the screw is finally tightened.

Many Die chucks have the power of *self-adjustment* for center; one of the earliest and best for light works, was contrived by Mr. S. Mordan, for accurately and rapidly mounting in the lathe the parts of his ever-pointed pencil cases. Mordan's *Self centering wire chuck* figs. 248 and 249, consists of two hardened steel dies, sliding in an undercut diametrical groove; the internal upright faces are each filed with an angular notch to hold the work, and the opposite external edges are accurately turned to a cone, of which each die forms exactly one half the diameter. A wide ring with a steel plate having a turned conical hole, screws upon the chuck, and by pressing upon the conical edges of the jaws

Fig. 248.

249.

Fig. 250.

251.

Fig. 252.



forces them equally to the center. The grasp of the hand is quite sufficient for securing the pieces to be turned, which vary from one sixteenth to one quarter of an inch in diameter, a second chuck being required to extend the range of work to half an inch.

Numerous self centering wire and die chucks with three slides, appear to have been derived from Mordan's, or from Hick's expanding mandrel, fig. 278, or are combinations of the two. Perhaps the best construction is that known as the Beach chuck, figs. 253 to 255; formed of three main pieces and three dies, and carried upon a conical plug which screws upon the mandrel.

The conical plug screwing upon the mandrel, fig. 253, carries the entire chuck upon a plain fitting turned in the first piece A., shown in section fig. 254. The central portion of the chuck B., is bored out behind to fit upon A., and is cut with a screw, while in front it is hollowed and turned

externally to a cone. The shell of the cone upon B., is completely severed along its entire length by three equi-distant parallel slits, for the insertion of the hardened steel dies, drawn also separately in two views, fig. 255. The three dies are precisely alike in all respects, their outer edges are filed to the angle of the cone B., and are formed with narrow fillets or enlargements, that are received in corresponding recesses at the sides of the slits, to prevent them dropping through the

Fig. 253.

Fig. 254.

Fig. 255.

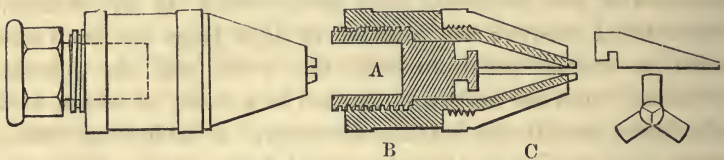

cone. The straight inner faces which grasp the work, are filed to a central angle of 120° , and at the base they have a transverse notch, fig. 255, loosely fitting the flat, button shaped front end of the piece A. The third piece of the chuck C., is a hollow cone permanently screwing to the front of B., to cover and retain the dies in position.

The dies being attached by their notches to the flat extremity of the piece A., traversing the front portions of the chuck further on to the screw of the latter, causes them to slide down the cone and to approach each other until they meet, when they also project beyond the front of the chuck; screwing the chuck in the reverse direction, causes them to retire up the cone, separating them to enlarge the grasp. Fig. 253 has but a limited range in diameter, while its many parts and the distance from the mandrel at which it supports the work, confines its use to wires, drills and small objects of round section, from a quarter of an inch in diameter downwards; a second chuck is required for objects ranging from one quarter, to five eighths of an inch in diameter. The grasp of the hand in turning either chuck, suffices to fix the work.

Self centering chucks with three slides, are confined to round work, and are obviously inapplicable to square and other regular or irregular sections. The round work also can no

longer be made to assume any eccentricity, necessary to counteract its own irregularities, to prevent undue waste of material or for other purposes, all easily accomplished in chucks that have *two slides*, self acting or otherwise; the round object therefore, also requires to be prepared more nearly true or straight, and usually takes the form of drawn wire, to which fig. 253 is particularly suitable.

The *Wire chuck with split dies* figs. 250. 251, has a limited power of adjustment and is convenient and simple in construction. A cylindrical recess in the front, is filled by several dies or plugs, bored with holes of definite sizes, varying not more than about one sixteenth of an inch in diameter; the plugs are sawn through for almost their entire length, and are closed upon the work by a binding screw, pressing upon a flat filed upon their sides. This chuck is employed for turning screws, pins and small objects, made from pieces of metal or wire which nearly fit the holes in the dies, and the gradations of size being small, very little material need be turned to waste. Similar chucks are employed to carry pieces of wood or metal of peculiar form, parts of which may require turning, as in fig. 252, in which the pivot to be turned or drilled, is also supposed to be inclined to the general axis of a piece of rectangular section. A plug or socket is made to the chuck, with the ordinary cylindrical hole replaced by an aperture, corresponding in form and angle with the particular piece to be turned, of which any number can then be exactly repeated.

SECTION III.—CHUCKS FOR SHORT OBJECTS, GRASPED BY THEIR EDGES. CHUCKS WITHOUT LOOSE PARTS.

These comprise various conical chucks, into and upon which the work is driven by light blows or by pressure. The *Plain*, *Cup*, or *Driving* chucks, fig. 256, the simplest of this group, are also those most widely used for the general purposes of turning. They consist of short, strong metal cylinders, bored or turned with plain apertures, very slightly taper, not exceeding 2° measured at the face; the internal diameters vary, from about one quarter of an inch to about six inches, the more intermediate sizes being most required.

The end of the piece of wood or ivory to be chucked, may be roughly rounded with the paring knife, hatchet or rasp, or with greater care by turning; the work is then slightly driven into the chuck and tested with a piece of chalk while in revolution, in the manner described for the prong chuck; it is then adjusted to truth by light blows delivered on the *end*, near to the edge and *opposite* to the chalk mark. The blows may be given with a hammer or mallet, with the end of a tool handle, poised horizontally in the fingers, or by the hand alone; and the hold thus obtained by the work in the chuck, suffices for many purposes of turning. Large or weighty work requires greater security, and for these cases, after the work has been adjusted for truth, the chuck is *removed* from the mandrel and stood upon some flat wooden surface, while one or more heavier blows are carefully delivered, centrally,

Fig. 256.

Fig. 257.

Fig. 258.

Fig. 259.

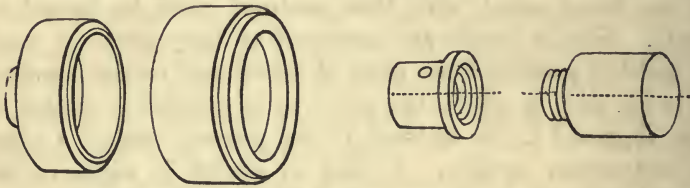

upon the end of the work. These, drive it further into the chuck without materially disturbing its truth, but, care is requisite to avoid bruising the face of the chuck, page 95, an accident highly detrimental to the truth of the latter.

The entrance of the work into the chuck may be much assisted, if after its first adjustment to center, the chisel be employed to turn true a narrow portion contiguous to the front of the chuck, to the size of its aperture and slightly taper, before driving it in; or else if in the first instance, the work be mounted between centers, and the end turned to the size and taper of the plain chuck, by which it is to be carried. The hold that is afforded by an eighth of an inch of true contact, is generally found to suffice for work of any ordinary diameter. Exact fitting between the two becomes still more important, when there is a probability that the work may have to remain for some days in progress, as a precaution against possible

loss of truth from the wood shrinking and loosening in the chuck ; an effect that will sometimes occur, even with dry and seasoned material. This may be provided against if the taper fittings on the work and the chuck, be made slightly longer than is at first necessary, when if requisite, the one may be subsequently advanced within or upon the other ; the pressure or the light blows employed, being delivered around the margin of the surface, and impartially on opposite sides, when with gentle management the work may be refixed with its previous truth restored.

With respect to the subject of chucking it cannot be too strongly affirmed, that all blows struck upon the work, when that is in a chuck *upon* the mandrel, should be given with very moderate force ; and this, not only to avoid damage occurring to the work, but also, which is of far greater importance, that no undue violence may be conveyed to the mandrel. It is soon appreciated in practice, that the advantage derived from the blows, depends more upon the precision of their direction than upon their force. Heavy, violent blows should always be entirely avoided, as they damage the work and defeat their purpose, by carrying it beyond the required position ; the attempted correction, then only transfers the want of truth from one point in the work to another. It is also possible to bend or otherwise damage the chuck, and even the nose of the mandrel, by a too forcible use of the hammer. Quick, sharp, rebounding blows, are also quite useless in chucking, the reaction from the latent elasticity of the work, chuck and mandrel rendering them ineffective. The most effective, which in contradistinction may be called *slow* blows, allow the hammer to remain upon the spot struck without rebound, and blows of this character are not only much easier to direct with precision, but are much less liable to produce damage.

Many works can be completely finished and then cut off leaving a piece remaining in the plain chuck, but more frequently the work requires separation when only partially completed, or it may have to be withdrawn, that the portion held within the chuck may then be turned and included as a part of the whole. In either case the finished form cannot be driven into a metal plain chuck without injury, while the work must also be rechucked in such a manner, that the portions

still to be turned, may be true or concentric with those previously executed. The driving chuck then takes the form of a plain cylinder of wood, usually boxwood, from about 2 to 6 inches diameter, fig. 257, screwing on the mandrel, and hollowed or turned away into interior or exterior rebates as occasion arises, to fit the particular diameter of the piece of work to be fixed in or upon it. Wood chucks of small diameter, which would be too weak if screwed upon the mandrel, are formed with an external screw by which they are carried in a brass receptacle chuck, figs. 258, 259.

The larger wood chucks are commonly made of beech wood the plank way of the grain; their truth is much improved, and

Fig. 260.

Fig. 261.

Fig. 262.

Fig. 263.

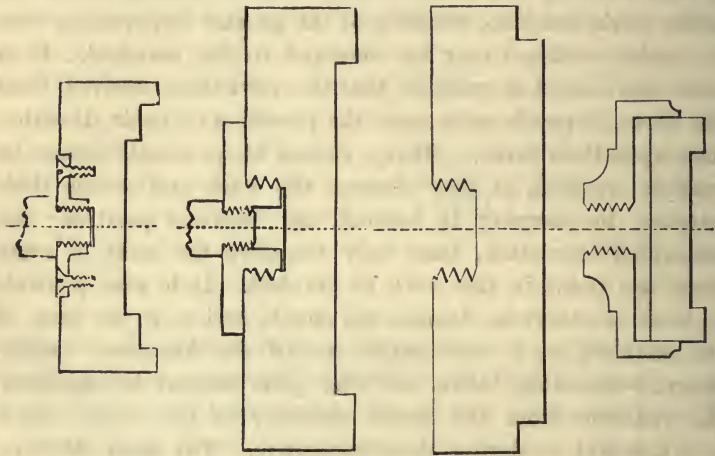

their attachment to the mandrel made more permanent, when they are provided with a brass flange fig. 260, the two parts being connected by short and strong joiner's screws. For the largest of these chucks, the flange fig. 261, is superior. This is of greater diameter and strength, and is provided with a short coarse thread about half the diameter of the flange, which fits corresponding internal screws cut in the wood chucks; several of which of different dimensions, are usually applied to the same flange. The face of the flange fig. 261, affords a support to the wood equivalent to that of an enlarged face to the mandrel; and in addition to the screw, this form of flange is sometimes also secured by the joiner's screws.

The several foregoing plain, wood chucks, are principally used for carrying partly finished works, already possessing a circular margin; and they acquire so little vibration under the turning tool, that they are particularly suitable for turning smooth surfaces and for finishing work. The elasticity of the wood affords a firm hold without indenting or damaging the surfaces, and the wood chucks are readily adapted by the turning tool to the particular diameter; but to prevent turning them to waste, a variety of sizes is necessary, that a chuck may always be selected that previous turnings have reduced nearly to the required size. The general convenience of the wood and metal driving chucks leads to their very extensive use, and in the following particulars of their management, many points may be observed that also necessarily apply to other chucks and to turning generally.

In rechucking the work, which may have been previously mounted in a metal chuck, between centers or otherwise, while the one end has been turned true and to the required form, it is necessary in order to ensure the entire piece possessing one uniform axis, that this true end when rechucked in the wood chuck, should again run exactly true or revolve upon the same axis as before. It cannot however do this, *unless* the chuck itself be exactly concentric with the axis of the mandrel; and this is attained in the most simple manner, by turning the chuck away to the size required by the work, when the true adjustment of the latter in the true chuck, perfectly maintains the one uniform axis throughout the work.

The quasi-cylindrical aperture, as also the external fitting for the reception of the work, is turned carefully true and very slightly, or about 2° taper; the edge upon the surface of the chuck, being also turned true. Internally, the aperture in the wood chuck usually terminates in a flat surface, upon which, and especially towards its edge more or less care is bestowed as may be required for the particular work in hand. The external fitting, figs. 257. 262, meets a narrow vertical margin or surface, called a "shoulder," and this is generally required to be turned accurately flat, under the guidance of a square.

The more usual application of the plain wood chuck is temporary and to individual works, and the mere alteration required to fit the work, at the same time renders the chuck

true. But, when a wood chuck is used continuously for any special purpose, especially such as require accuracy, its comparative want of permanence of form due to atmospheric influence, requires correction from day to day; but a shaving removed from its different surfaces with a tool held very steadily, at once restores its perfect truth. The work is very frequently pressed into the wood chuck by the fingers and adjusted to truth by them alone; but when greater hold is required it is obtained by light blows, given by the tool handle or hammer upon the end of the work, as with the metal plain chuck; still less force being used, to avoid risk of splitting the chuck or of damage to the work.

Any error in the truth of adjustment in the chuck of long pieces, is sufficiently obvious, a piece of chalk, or a turning tool applied towards the extreme end, detecting the high point for correction. With many works of moderate length, the finished portion contiguous to the chuck is observed while in revolution, and the mouldings or other projections turned upon it, are compared with the true edge of the chuck, and the one adjusted to the other by pressure or taps with the tool handle. When the work is short or thin, the error is less easy of detection; the adjustment can then sometimes be materially assisted, by turning a portion at *both* ends perfectly true, when the work is between centers or in its other first chucking; these two parts are necessarily parallel and possess one axis, consequently at the second chucking, it is only necessary to test and adjust to truth the accessible part previously turned, to ensure the agreement and truth of the part concealed within the chuck.

The truth of the work is also frequently attained by its being placed in contact with the true surface of the recess, or the shoulder of the rebate; but in this case the work is *pushed* into the chuck by the fingers, the ball of the thumb, or the end of a tool handle, and not driven; for should blows be employed, the work may strike the bottom and rebound from the elasticity of the materials, the more so the greater the force employed. The truth of adjustment of bright works in metal is easily tested by the reflection of any fixed object; which should appear perfectly at rest, when seen in their rounded edges, or other curved surfaces, that have been previously turned true.

For work that is fragile and can bear but little compression, the chuck is turned away to permit its comparatively easy introduction; the edges of the rebate being then rubbed as they revolve with a piece of chalk, to assist the hold upon the work. When by accident the work has been misfitted, and the chuck does not permit of further turning, one or two thicknesses of paper may be placed between them as a remedy; the paper is sometimes placed over the chuck in a single piece like the head of a drum, or it may be used as narrow strips or ribbons placed radially. In unchucking from either the wood or metal driving chucks, if the work be long, a few light blows of the hand, the end of a tool handle or a mallet, given upon the *side* of the work towards the end, and continually at different parts of its circumference suffice to release it. For very short pieces, the chuck may be unscrewed from the mandrel and held in the hand with the work uppermost, when a sharp blow from a hammer struck upon the margin of the chuck, will cause it to fall out from the reaction. Occasionally a piece of hardwood is inserted through the screw of the chuck and struck against the end of the work. At other times the edge of a turning tool placed against or beneath, any projecting edge upon it, is used as a lever to prize it out of the chuck. Should any of these methods appear likely to damage the work, or when that is too firmly fixed for easy removal, the wood chuck should be turned away with a parting or flat tool, until the portion holding the work is reduced to a thin shell, when it can be readily removed with the fingers.

The elasticity of the material, which affords so valuable a hold upon the work, slightly interferes however with the trustworthiness of the screw attaching the wood chuck to the mandrel; the compressibility of the wood causing the position of the chuck to slightly vary, according to the degree of force used to screw it up to the face of the mandrel. This is quite unimportant for the larger number of works, a true concentric fitting being always turned, when the chuck is screwed up to its place. Inconvenience only arises when the chuck has to be frequently removed and replaced, as for continual examination of work in progress, or, as in turning a series of exactly duplicate pieces in separate wood chucks, in order that each piece may successively come under the operation of fixed tools

in the slide rest, themselves also frequently changed ; entailing continual removal and replacement of the chucks. In such cases, the want of truth caused by the wood chucks screwing a little more or less round or *home* upon the mandrel, becomes a serious evil, and it is naturally more felt, when the chucks have been some time in use and their screws have become worn.

For accurate purposes, the ordinary metal plain chuck is filled with a wood plug, to be turned away to fit the work ; thus combining the elasticity of the wood for the hold, with the more constant position of the metal screw upon the mandrel. The waste ends of wood left from work that has been driven into the plain metal chucks, are usually allowed to remain to serve this purpose, care being taken to observe whether they have at all shrunk or loosened in the chuck before using them ; but for important work, the wooden plug or stopper is made of greater length, and is very carefully turned to exactly agree with the taper of the chuck, fig. 263, before it is driven in. Light metal works, are frequently turned in plain wood chucks and in those stopped with wood ; but when much material has to be turned away, the heat evolved causes the wood to shrink and sometimes to release the work from the chuck prior to completion. The plain metal chuck is more efficient for metal turning when filled with lead, to be turned to fit the work the same as the wood ; the lead holds the work with great tenacity, its softness affording the utmost surface contact, while from being almost inelastic it is nearly insensible to the jars and shocks from the tool, felt and returned by the wood and metal chucks. The chuck is made hot before pouring in the melted lead, and the screw for the mandrel is covered, either by a piece of sheet metal or by a conical plug ; the latter, casting the lead hollow and so far prepared for use. Sometimes the lead sufficiently contracts in cooling to become loose in the chuck, in which case it is spread by the blows of a hammer, *before* the chuck is placed on the mandrel. When the aperture is slightly too large for the work, the lead may be spread internally in like manner, after which the work is fitted with the turning tool. Fresh lead may also be cast upon the old portion, to fill up the aperture ; the surfaces should then be turned clean and also be a little undercut

or jagged, and the new metal poured rather hotter than usual, when it melts the old and adheres to it.

Although the foregoing plain chucks are also called driving chucks, it should be remarked, that the work is never fixed therein by *hard driving* with the hammer, which is alike injurious to the lathe and its products. The work is retained principally by the correctness of its contact with the taper sides of the aperture, the hammer being only used to adjust the position of the work, and then to place it in intimate contact with the chuck; in both of which, the precision of the direction and not the force of the blows is the essential. The slightly conical or taper holding surfaces of the plain chucks may be compared with the wedge, their grasp upon the work being precisely the same as the splitting power of the wedge, viz., the greater, as it is of a longer or more gradual taper. The most retentive hold is obtained, when the sides, either internal or external, are turned to the angle shown by the lines, fig. 264, which differ about half an inch in each foot, forming an acute and powerful wedge of about 2° . But the purpose of this wedge being that of fixing, and not splitting

Fig. 264.

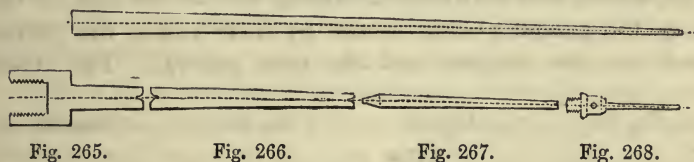

Fig. 265.

Fig. 266.

Fig. 267.

Fig. 268.

either the chuck or the work, sufficiently explains the necessity for *moderate force* in the blows given with the hammer, as also the preference for still less force by any other means, whenever the hammer can be dispensed with.

The *Arbors and arbor chucks*, figs. 265 to 268, are used to chuck metal washers, rings, tubes and other objects of all materials, having central holes. The surface of the arbor is an extension in length of the outside fittings turned upon the driving chuck, the taper being the same as fig. 264. The arbor chuck fig. 265, screws upon the mandrel; fig. 266, has a hollow center at each end for use with the center chucks; the arbor fig. 267, is for less exact purposes, one end being

square to adapt it to the square hole chuck; and fig. 268, is one of a series of small interchangeable arbors, screwing into a small double screw receptacle chuck similar to fig. 258.

The arbors for metal works are generally made of iron, sometimes of steel, and occasionally for other materials, of brass or wood, with or without steel centers. The work to be fixed is laid across the chops of the vice, when opened to a little more than the diameter of the arbor, which is then slightly driven into the piece after the manner of a nail; a piece of brass or wood being first placed on the arbor to receive the blow, and prevent its center being bruised. More delicate works are placed on the arbor when on the mandrel, and are fixed by pressure upon their sides given with a tool handle, and many works in ivory and wood are pressed on by the fingers alone. For tubes or long collars, the arbor requires to be nearly cylindrical, except at one end; the wooden arbor fig. 196, is quite cylindrical except at the chuck end, where it tapers to engage in the end of the tube carried upon it.

CHUCKS WITH LOOSE PARTS.

Of the various chucks with movable parts having the power of expansion and contraction, forming the second half of the group for grasping short works by their edges, the spring chucks are the simplest and the most general. The *Wood*

Fig. 269.

Fig. 270.

Fig. 271.

Fig. 272.

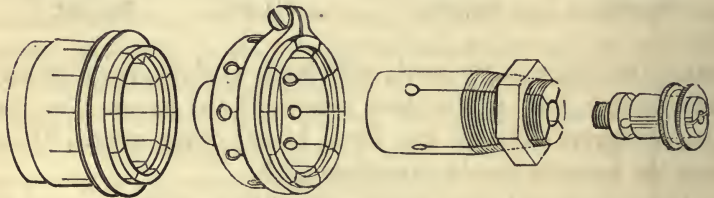

Spring chuck fig. 269, hollow, and slightly taper externally, is rendered elastic by two or several, diametrical saw-kerfs, cut down nearly to the back of the chuck, which latter is strengthened and prevented from splitting by a metal ferrule, fitted around the solid end. Fig. 269, is turned out to fit the work in the same manner as the plain wood chuck, the sections are then compressed upon it, by forcing a metal ring

or hoop up the conical exterior. The most elastic of the spring chucks are made of boxwood, and vary in diameter of aperture from about a quarter of an inch to about six inches, the most useful being for works from about two to four inches in diameter; still larger sizes are occasionally made of other woods. Previously to fitting the work, the ring is pressed on to support the staves, so as to place the chuck under about the same restraint, as when it carries the work; the recess, which is often but a narrow and shallow fillet, is then carefully turned true and flat at the bottom, and the ring having been loosened, the work is pressed down to the bottom of the recess, and fixed, by moderately driving on the ring. Spring chucks are employed for partly finished works, and are particularly convenient for re-chucking work from which no material can be wasted, or, that does not permit of being placed in the plain wood chucks. Among the latter are objects of a fragile character, and others having projections upon their surfaces. The recess being turned of sufficient size to permit the easy introduction of the first, the ring may be pressed on by the hand alone, or by gentle taps at different points of its circumference, given with the tool handle, or by pressing the latter against the face of the ring whilst in revolution; just sufficient compression can thus be given, without risk of breaking the most delicate work.

With work of the second characteristic, when the projections on the surface are small and at regular intervals, the recess is turned of sufficient size to grasp the work by them, and they then indent or slightly cut into the sides of the wood chuck when the pressure is given by the ring. Portions of the chuck are cut away to receive large projections, or for those irregularly placed upon the work, so as to permit the main piece of the latter to be held by the recess. Squares and polygonal figures are carried in a similar manner, the corners of their bases resting on the bottom of the recess, the staves grasping them by their angles; and wood spring chucks are largely used for many purposes in plain and ornamental turning, of which examples will be given.

Metal spring chucks, are made in various proportions in brass and in iron, their application is usually reversed, the end of the work being turned to the size of the rebates or apertures

made in the chucks, which are not interfered with; a fair variety of sizes is requisite, that a chuck may always be selected that nearly agrees with the diameter of the work. The more general closely resemble thin, ordinary brass plain chucks, turned with a true internal rebate, cut into staves and closed by an external ring. The entire chuck being of metal, it maintains a more constant position on the mandrel and is therefore more trustworthy for turning duplicate pieces with the slide rest, or when the chuck has to be frequently removed and replaced on the mandrel. They are also of advantage when partially finished work has to be laid aside for a period, the work will then sometimes become loose from shrinkage when in an ordinary plain chuck, a great inconvenience, especially in ornamental turning, but entirely obviated by the metal spring chucks. The plain steel ring is generally used to compress the staves, but this is sometimes exchanged for a divided clip ring having a side screw, fig. 270, closing both the ring and the chuck. The ring also sometimes takes the form of a nut on a taper screw, as in fig. 271; this chuck is divided by two long diametrical saw cuts, giving it a small power of contraction, it is strong, and very suitable for holding wires and round objects not exceeding half an inch in diameter. The smaller wire chuck fig. 272, externally a plain taper, is closed by a taper steel ring driven on; various sizes of this chuck screwing into one receptacle chuck.

The metal spring chucks require to be sufficiently rigid to withstand the resistance of the tool upon the work without vibration, their elasticity is consequently slight, which limits their application to works turned to very nearly the same diameter as themselves; and this circumstance has led to some attempts at modification in their construction. The advantages of the metal back and screw for the mandrel, and the more elastic hold of the wood for the work, are sometimes combined, fig. 273; while by one ingenious arrangement fig. 274, the elastic portion of the chuck is separate from that which affords solidity.

In the former variety, a brass flange the back of which screws on the mandrel, is also screwed by its edge into the wooden portion of the chuck, this is turned as a rather thin tube, and cut across by the saw in the usual manner; the

back end of the wood tube is strengthened and compressed upon the flange by an external metal band or ferrule, and the staves are closed upon the work as in an ordinary spring chuck; which latter however, the combined form, fig. 273, does not nearly approach in strength. In the second arrangement above alluded to, the chuck is formed of a strong hollow metal cylinder, very similar to the plain chuck fig. 256; but cut externally as a screw, upon which there is a screw ring, having a conical aperture at its front end. Fitting within this chuck, is a thin split brass tube, fig. 274, the front of which is formed as a strong conical flange also split, and of about the same diameter and angle as the aperture in the screw ring. The

Fig. 273.

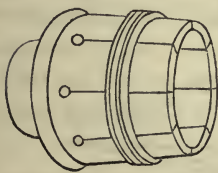

Fig. 274.

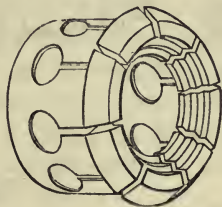
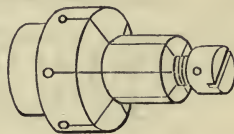

Fig. 275.



flange is turned with one or two internal rebates for the reception of the work, and the tube is rendered very elastic by several wide saw cuts which terminate in large holes; screwing the ring on to the chuck, causes a diametrical contraction of the flange upon the work, while the necessary rigidity is supplied by the intimate contact of the chuck, the ring and the flange. The split tubes may be made as a series, when one chuck provided with two or three tubes fitting one within the other, serves for an increased variety of diameter.

The spring chuck fig. 275, is a plain brass socket screwing on the mandrel, divided by two or more diametrical saw cuts, it possesses a very small power of expansion outwards, the reverse direction to all the preceding; the sections are expanded by means of a short conical screw in the center of the chuck, which is tapped to receive it. Fig. 275, as nearly allied to the expanding arbors as to the spring chucks, is a very convenient workshop tool used for finishing and polishing light works held by their central holes; when these apertures

do not pass through the work, the chuck may be expanded from behind, the screw being then inserted through the aperture by which the chuck is attached to the mandrel.

The solid arbors or mandrels figs. 265—268, are necessarily limited in their application to the extremes of their own diameters. Several useful contrivances, the converse of the spring chucks, in which the arbor or mandrel expands within the work, are employed to increase the range of diameter, and these are especially useful in manufactories to reduce the number of solid arbors otherwise necessary; they also afford

Fig. 276.

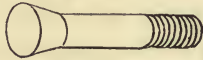

Fig. 277.

Fig. 278.

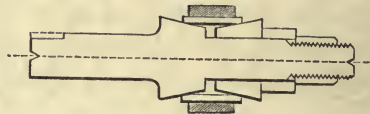
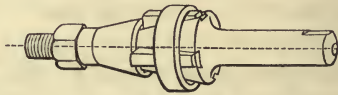

Fig. 279.

facilities for fixing and unfixing the work without risk of damage, which may sometimes occur in driving finished work on or off the common arbor.

The expanding arbor, figs. 276, 277, is employed in Brunel's block machinery at Portsmouth, to fix the wooden sheaves for the completion of their sides and edges in the surface turning lathe, after the metal centers or coggings have been inlaid, riveted and broached by their respective engines. The sheave is fixed by a cylindrical bolt having a conical head, fitted with a corresponding ring turned cylindrical externally and to the size of the hole in the sheave. The ring is divided into three pieces, expanding when the bolt is drawn in, by a nut at the back of the mandrel; the whole sinking below the level of the surface, leaving that and the edge of the sheave entirely free for the turning tool. A groove is turned in the edges of the segments to receive a spring hoop, which surrounds and retains them in position while the work is being changed; different divided rings being employed for various sized holes.

The *Expanding Mandrel*, fig. 278, was contrived by Mr. John Hick for use with the center chuck. This, has a cone in the solid having four undercut diametrical grooves upon its surface, for the reception of four steel wedges or slides, turned cylindrical upon their outer edges. The wedges are equally advanced by the nut and washer at the screwed end of the arbor, until as shown, they fill out and fix the ring or collar to be turned. Mr. Hick's mandrels are made of several sizes, to adapt them to works in which the apertures range from about one, to about twelve inches in diameter; the extent of expansion being from about half an inch in diameter in the smallest, to about two inches in the largest sizes.

In Mr. Yuile's expanding mandrel, shown in section fig. 280; the cone directly extends the wedges. A solid mandrel turned to a long cone about the center of its length, is contained by a cylindrical tube, within which it is traversed by a screw, cut upon one end. The tube is pierced by three radial slots, fitted with steel wedges, the same angle inside as the cone, their outer edges turned cylindrical and level with the surface of the

Fig. 280.

Fig. 281.

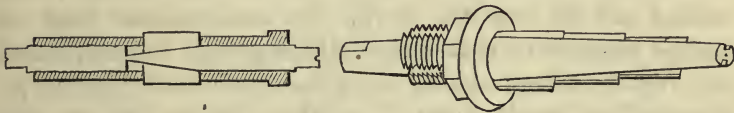

tube. The ends of the solid mandrel are filed square and centered; one end of its casing is formed as a hexagon to receive a key, to turn the one within the other, when as the cone advances it equally projects the three wedges and fixes the work. Mr. Le Count's expanding mandrel fig. 281, appears to be derived from fig. 278; it is a gradual taper for about two thirds of its length, from which point it becomes cylindrical and is cut as a screw. Three radial grooves with vertical sides, agreeing with its taper, are planed along its entire length, and carry three long thin wedges, with their outer edges turned cylindrical and in steps. The wedges are connected by a portion at their butt ends, similar to a narrow fourth step, working in a plain cylindrical groove turned within

the collar, which traversed upon the screw by the nut, carries the wedges up and down the cone to agree with the diameter of the work. Fig 281, is constructed for small works ranging from half an inch to four inches internal diameter; one or two are required, the extent of the expansion of each mandrel, viz., half an inch in the smaller and one inch in the larger sizes, being about the same as in that of Mr. Hick. With all the foregoing mandrels, the wedges are first sufficiently screwed up to hold the work during its adjustment to truth edgewise; after which, the nut is further screwed up by hand or by a key.

The *Double Cone expanding mandrel*, shown in section fig. 279, is a contrivance that may be entirely made in the lathe. The shaft is cylindrical, except at the center where it is enlarged by a cone, and a similar but reversed cone, accurately bored to fit upon the shaft, is advanced to the first by a screw and nut at the end; the work is held between the two cones by the edges of the hole, which may be either taper or cylindrical. To increase the surface contact, fig. 279, is sometimes completed by a series of rings, slightly increasing in external diameter with their inner edges turned conically; the rings are afterwards cut through at one place, either parallel with, or inclined to their axis, when on advancing the cone, they expand and fill out the work. To accommodate work of various diameters a nest of thin split rings may be used, placed one over the other; thicker rings made sufficiently yielding by a second cut nearly through on the opposite side are also sometimes employed, as also thick rings, entirely divided, with or without a clip spring, as in Sir I. Brunel's original contrivance. Expanding rings have advantages for carrying thin works, which, liable to distortion when supported at three or four points only, do not suffer when subjected to pressure from within their entire circumference; while, should the turning tool be accidentally advanced too far, in place of three or four separate ridges, it encounters a uniform circular surface by which it is not so liable to be damaged.

The self-centering action of the expanding arbors, noticed also in some of the die chucks, is employed for larger works in various forms of *Universal chucks*; in which, two, three or four jaws, simultaneously advance to or from the center, to

which they adjust the work, held either by its external or internal edges.

One of the earlier Universal chucks, constructed in 1811 and for many subsequent years by Holtzapffel and Deyerlein, is shown by figs. 282. 283. This chuck is formed of two plates fitting one upon the other, the front fig. 282, has three radial grooves, and the back three semi-circular grooves; the screw by which the chuck attaches to the mandrel being removed from the back in the woodcut fig. 283. The two portions of the chuck receive a semi-revolution one upon the other, by a tangent screw attached to the front plate, which works in a portion of a worm wheel cut or fixed upon the edge of the back plate; the changes of position thus produced in the respective intersections of the radial by the circular grooves, are exactly alike in all three, and determine the distance of the jaws from the center.

To accommodate the sliding clamps for holding the work, to the varying intersections, they are each made in two parts;

Fig. 282.

Fig. 283.

Fig. 284.

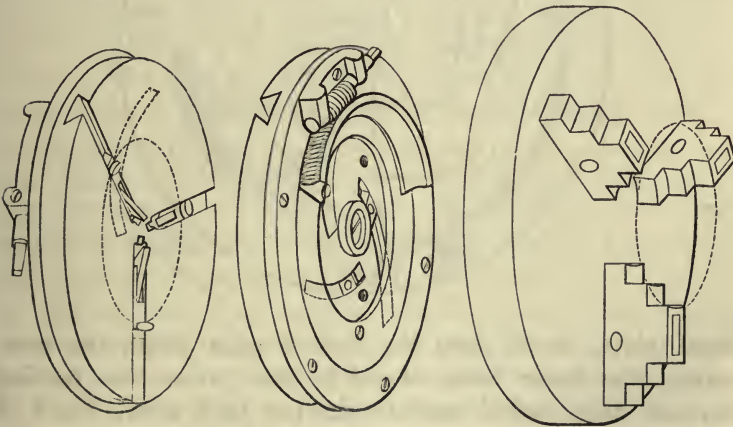

the one straight to fit the radial grooves, and the other curved to fit the circular grooves, the two halves being joined to swivel together by a central pin or axis. The work is held either from within or without by projecting portions of the clamps, filed as studs, or as steps, or as in fig. 282, in which the jaws are also provided with small balanced clamps, which

when out of use, lie level with their surface, but when tilted up, contract the grasp of the chuck to works of the smallest diameter.

This method of giving equal motion to the jaws, appears to have been independently pursued by many persons. The Universal chuck fig. 285, is described in the second edition of the *Manuel du Tourneur*. 1818. The wood cut which represents the front plate as broken away to show the mechanism, is copied from that work. The chuck has three straight arms moving upon centers near its circumference, carrying the clamps to grasp the work, pivotted at their inner extremities. The pivots of the clamps pass through circular mortises in the

Fig. 285.

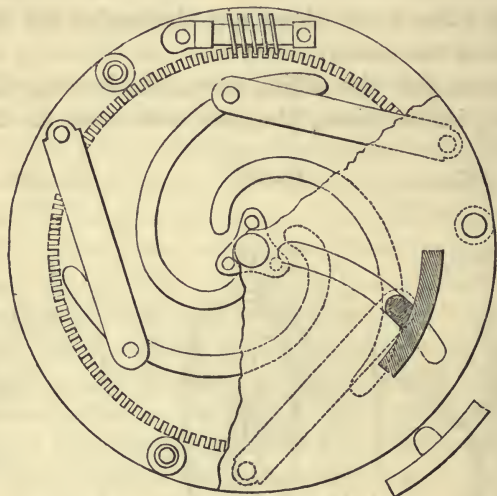

front plate, struck from the centers upon which the arms swing; the latter being closed by the pivots also passing through three spiral mortises in the back plate, which is twisted round by a tangent screw as in the last example. The equal intersections of the circular by the spiral grooves, forcing the clamps to travel to or from the center.

Mr. Thomas Hack received an award from the Society of Arts in 1819 for a variety of fig. 285, having four jaws. The arms are jointed to the circumference of the *back* or moving plate, and are closed by the pivots of their jaws working in

straight mortises filed in the front plate, cut at an angle of about 12° with the radius. Mr. Alexander Bell about the same time contrived a chuck with three jaws, the arms for which were jointed near the center of the back plate, instead of at its circumference, the slits in the front plate, being at about twice the previous angle, but in other respects the chucks are almost the same. The tangent screw or spiral plate are not employed in either of these chucks, which close their jaws, upon turning the back plate about one third round, by a key or plain lever; the strength of the grip depending principally upon the friction of the parts, which is also to some extent the case, in figs 282 and 285.

The Universal chuck, now sometimes called the *Scroll Chuck*, fig. 284, consists of a less number of parts, and was contrived and first introduced in 1842, by Mr. James Dundas of Queensferry, N.B. The front plate has three radial grooves, hidden by the steel dies, which latter, have their external and internal edges turned in steps. For the equal advance of these dies, the *face* of the back plate is cut into one single continuous spiral, extending from the center to the circumference, and the reverse portions of the dies, below the front plate, are cut into teeth nearly agreeing with the spiral in which they engage; to cause the dies to grasp the work, the front of the chuck is twisted round upon the back, by hand or by a plain lever.

In this and analogous chucks, the grooves or teeth cut in the under sides of the dies, can only accurately correspond each with its respective portion of the single spiral; but, as no two parts of this curve are alike, it follows, that if the dies be cut to fit absolutely, the teeth must be more curved than the spiral, as they recede from the center and the reverse, as they approach it. The curved teeth of the dies therefore require to fit the spiral groove easily, or to have a sufficient play to permit them a radial traverse of about one inch; this suffices to accommodate the difference of diameters between the steps forming the jaws, so as to hold work of any diameter between the extremes for which the chuck is constructed, but, it also reduces the security of the grip. The teeth have been sometimes formed as one or more round pins, the width of the spiral in diameter, but the contact being then less, the hold is

still less secure. Self-centering chucks with *three jaws*, are only employed for objects that are already circular or very nearly so; their construction entirely preventing any lateral shifting of the work, required to accommodate other than round pieces; or even its slight eccentric adjustment, already explained as so constantly necessary, when the axis of the piece does not happen to be quite central with the base by which it is held, restrictions which considerably reduce the convenience of the chucks.

The grasp upon the work, principally sustained by the friction of the parts in the foregoing universal chucks, is also liable to interference from elasticity or unequal wear; this in some degree interferes with the centrality of the chuck, and from the same cause, the work while under operation sometimes escapes or is thrown out of the chuck with more or less

Fig. 286.

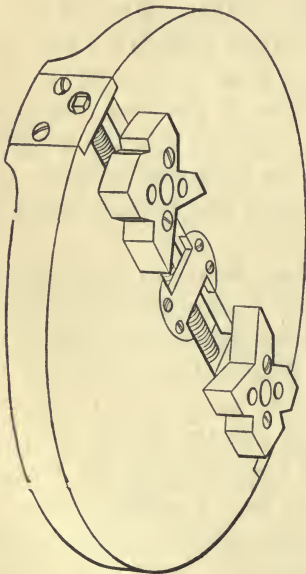
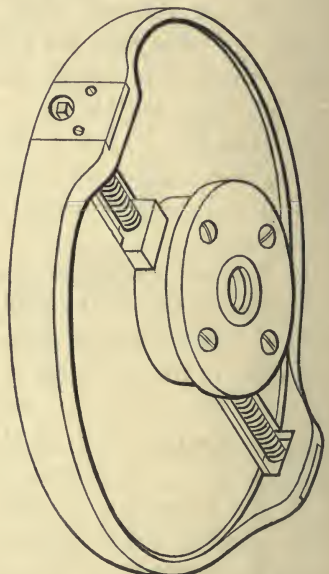

Fig. 287.



violence. These various objections led to the gradual disuse of the three jaws and to the adoption of simpler, yet more comprehensive forms, one of which is shown by figs. 286, 287. On the other hand, the constructions described have of late years been almost exactly reproduced in some variety of shapes;

these however do not appear to call for particular notice, except that many among them have additional disadvantages, from being carried upon arbors or plugs fitting either within or upon the mandrel.

The Universal chuck figs. 286. 287, has one diametrical groove carrying two steel jaws, moved simultaneously to and from the center by a single screw, the two halves of which are right and left handed in thread ; both ends of the screw, which should be just below the periphery of the chuck, terminate in squares for the key, by which it is moved to traverse the jaws, which latter exercise a powerful and direct vice-like grip upon the work. Several pairs of jaws are sometimes employed, or more conveniently, the four sides of the jaws are filed in pairs, any of which can be placed towards the center as in fig. 286. Their angular form retains the work in the diametrical line in the one direction, while their simultaneous advance also places it central in the other ; and the *two* jaws, do not interfere with the selection of the best position, for work that requires slight eccentricity in its adjustment. Upon the five inch center lathe, fig. 286, can be arranged to carry round pieces from half an inch to five inches in diameter ; and when the jaws are moved outwards, rings and hollow works with apertures ranging from three and a half, to five inches internal diameter. Smaller sized chucks upon this model, are also convenient for lighter work. Work of square, oblong, oval or irregular section may be securely held, either by the notches or by the flat sides of the jaws ; and the facility afforded for chucking large or rough pieces of material, causes fig. 286, to be largely employed for the preparation of works that are to be subsequently held in the plain and other chucks. For this purpose it is more rapid and convenient than the prong and center chucks : it is employed to carry the piece while the one surface, its inner, or its outer edges are turned to fit other portions of the work, or in, or upon the plain chuck, when the side previously held by the jaws, may then be turned concentric with that already finished.

Universal chucks similar in form, many of them of very large size, but with two or four independent screws and jaws, are also used by the engineer ; sometimes also two jaws are moved simultaneously and two others independently. Equal

bevil pinions have also been attached to the outer or inner ends of the four separate screws, with the addition of a back plate having a crown wheel cut upon its face, taking into the whole moving them simultaneously; this arrangement however does not compare favorably with the more direct action of the right and left handed screw, the first application of which to the Universal chuck is attributed to the late Mr. Maudslay. All the universal chucks can be easily made to exert considerable force upon the work, even to its injury, or to that of the screws of the chuck itself; no greater force therefore than is necessary should be employed, while to give increased steadiness to the hold, the base of the work whether that be light or heavy, should rest upon the plate of the chuck. Flat, thin, or hollow works, are more or less liable to be distorted and bent out of shape by too great pressure from the jaws, and the flat surface or circular form produced upon them, when unduly compressed, is disturbed by the material returning to its natural tension when released from the chuck. Thin hollow objects are temporarily filled by a wooden or other plug, to enable them to better withstand the thrust of the jaws.

The *Surface chuck with Dogs* for holding works by their edges, fig. 288, consists of a flat plate of metal screwing on the mandrel, pierced with numerous plain holes for the dogs, one of which is shown separately fig. 291. The heads of the dogs are no thicker than is requisite, to carry the flat ended pinching screws, and they are fixed by nuts and washers behind the plate.

Concentric work is fixed by the dogs placed at equal distances from the center, with their screws pointing radially, the dogs being either within or without the work and sometimes in both positions, as may prove most convenient. Irregular forms, such as the arm represented as mounted on the chuck, may be thus held, so that the entire surface as also the projecting collar, can be turned or bored without the dogs interfering with the action of the tool; which latter from the intermittent cutting, is advanced to the work in the slide rest. Fig. 288, also conveniently ensures parallelism in the two sides of castings or forgings, of the character of figs. 289 to 293, it being only necessary when the first side has been turned, that it should be placed in exact

contact with the surface of the chuck, when the work is refixed to turn the second side.

Thin, flat works, are sometimes raised upon a parallel piece of wood interposed between them and the chuck, to place their surfaces just above the heads of the dogs. Parallel lifting pieces are also used beneath surfaces carrying projections, when the opposite surface is turned, to cause that to lie level with the surface of the chuck; washers are then placed beneath the heads of the dogs, to raise and adapt them to the increased height. The numerous holes allow every variety of position for fixing different shaped works, and as the dogs cannot slip away from the work, surface chucks with holes are very gene-

Fig. 288.

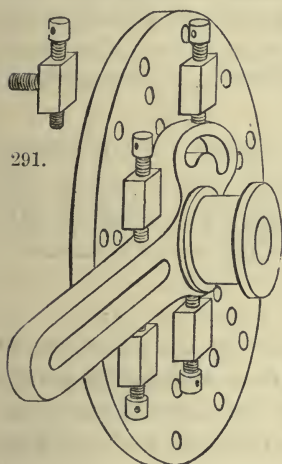

Fig. 289.

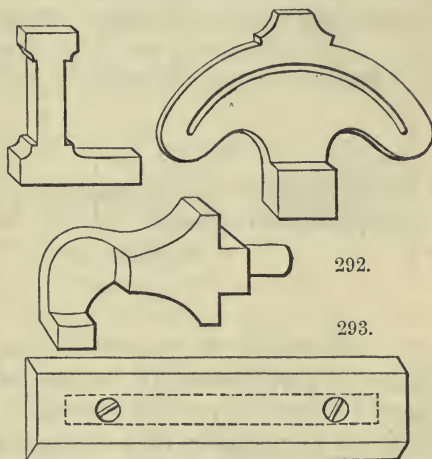

Fig. 290.

rally preferred for metal turning. When the work will permit of tapped holes being made for the purpose, in parts which would be afterwards cut away, it may be secured by bolts screwed through from behind the chuck; bolts or screws may also be passed through from the front, the holes in the work are then countersunk, to allow their heads to lie below the level of the surface being turned, as in the slide, fig. 293, for which this method is convenient from its edges not being rectangular. When employed for wood turning, the chuck is frequently made with radial slots, fig. 305, and the pinching screws are generally pointed.

SECTION IV.—CHUCKS FOR SHORT OBJECTS FIXED AGAINST ONE OF THEIR SURFACES.

The *Screw worm* chuck, fig. 295, the most common of the chucks with central screws, consists of a flat brass or iron flange, from about two to four inches diameter with a taper steel screw of a coarse, thin thread; one or two of these chucks having screws of different dimensions are convenient, so that as large a screw may be used as the nature of the work will permit.

The screw worm chuck is principally employed for pieces of wood, cut the plankway of the grain. With the softer woods, a small hole is bored in the work with a gimlet, or drilled in the lathe, and the screw worm then forces its way in and obtains a secure hold, its threads interlacing among the longitudinal fibres of the material. With the harder and therefore

Fig. 294.



Fig. 295.



Fig. 296.

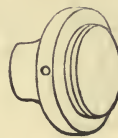
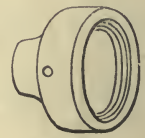

Fig. 297.



less compressible woods, the hole to receive the screw has to be made proportionately larger, and it is still better that it should be made taper and somewhat to the shape of the worm. When it is necessary that the surface of the work should be left intact, a thin parallel piece of waste plank wood is first screwed on to the chuck, to occupy a portion of the screw, which is thus prevented from passing completely through the work. The chuck is occasionally employed for short blocks the end way of the grain, but in such case the hold is rather imperfect, as the screw, fig. 294, then cuts across the fibres of the wood, dividing them into short lengths, easily broken away. A better method for carrying pieces the end way of the grain, is afforded by gluing a piece of plank wood on the end of the block to receive the screw, and in either case when possible, the opposite end is supported by the popit head.

The work is screwed upon the chuck when that is on the

mandrel, in order that the lathe may be set in gentle motion once or twice during the process, to observe that the face of the work is kept parallel with the face of the flange. When the one bears fairly on the surface of the other, the hold is secure, and the work may be unscrewed and replaced as often as required; but, if the work be screwed on obliquely, so as to touch only on one side of the flange, it is liable to be screwed further round by any sudden jerk or catch of the tool in the progress of the turning, when the fresh position thus given to the work throws the previously turned portion out of truth. The leverage exerted by the work in such case, may sometimes also either bend or break the screw.

The *Double Screw chucks* afford a somewhat similar, and a very ready means of holding numerous pieces in hardwood, ivory and metal, the screws of which thus serve first for the chucking, and then for the attachment to each other of the various parts of the finished works; the entire circumference

Fig. 298.

Fig. 299.

Fig. 300.

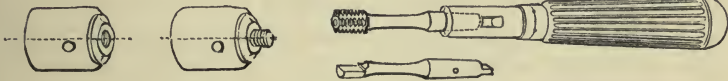

Fig. 301.

of every piece, the one surface and a part of the other, being all accessible to the turning tool when mounted upon the chuck. The chucks are made in pairs, from the size of the smallest screws used in mechanism, figs. 298, 299, to those of three or four inches in diameter, figs. 296, 297, cut upon the solid chuck; the external and internal screws of the smaller sizes are usually inserted and made of steel. The convenience of the smaller double screw chucks is largely increased, when they are each provided with appropriate taps, to cut the internal screw in the work. The taps may be distinct, or several sizes may be carried in one handle, figs. 300, 301; they are used in the manner and with the same precautions, described for tapping and cutting the internal screws by which the wood and metal chucks fit on the mandrel. The external screws upon the work, may be cut with the screw tool by the hand

alone, with the traversing mandrel or by a diestock; the smaller double screw chucks, offering additional facilities, when their screws are made to the sizes of the threads cut by different diestocks.

The *Screw Arbor* chucks, which bear some analogy to the expanding mandrels, are used for works having central holes. Fig. 302 has a flange and long arbor, to extend through hollow work of varying thickness; it requires a variety of washers of different diameters and lengths, to fill the remainder of the

Fig. 302.

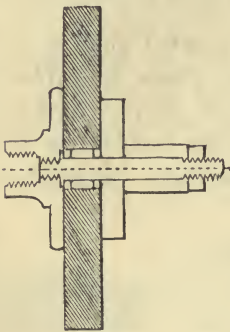

Fig. 303.

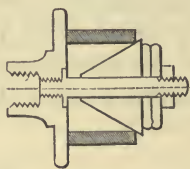
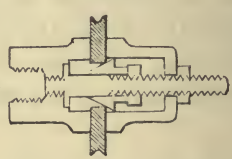

Fig. 304.



central arbor not occupied by the work, the whole being clamped together by a nut and screw at the end. When the aperture in the work is of larger diameter than the arbor, it is brought central by small collars of wood or metal, bored to fit the arbor, and turned externally to the diameter in the work, fig. 302; and these collars being only required to give the position, may be of any thickness less than the work, a washer or ring of sheet metal being often sufficient for the purpose.

The *Arbor chuck* fig. 303, in addition to the nut and washers, has a cone accurately fitted upon the central stem, serving both to adjust and hold the work. The cone is hardly sufficient for the latter purpose, unless a broad chamfer be turned upon the work to increase the surface contact, while thin works run some risk of being split or expanded. The *Disc chuck* fig. 304 contrived by the late Professor Willis, very neatly combines the effective portions of the two previous chucks. The cone and its nut are only employed to place the work true by its central hole, the work is then securely grasped between the

broad edge of the chuck and that of a hollow washer, brought up by a second nut and enclosing the position cone.

Screw arbor chucks are used for works already partially completed such as discs and wheels, which may be fixed in this manner whilst their edges are turned or cut into teeth; in such cases the stability of the arbor chuck may be sometimes advisedly increased by the support of the popit head. Many similar contrivances are made to run between centers, or in the square hole chuck, these are usually for some definite purpose, such as the spindles for saws, circular cutters and similar tools.

Surface chucks for fixing works in contact with their faces vary in material and dimensions, but all present a plain flat surface, to which the work is fixed by different methods; they are used both for wood and metal turning, and are essential to a large proportion of the latter works. The *Cement chuck* used for wood and ivory, is usually a plain boxwood chuck from about one to four inches in diameter; the face of this is turned to a surface, and subsequently, for the better adhesion of the cement, the surface is slightly roughened or else scratched full of rings, turned upon it with a point tool or an outside screw tool. A stick of turner's cement, prepared as described, page 160, Vol. I., is pressed hard against the chuck while in rapid revolution, until a uniform coating of about one sixteenth of an inch thick, is melted upon it by the friction. The work held in the fingers is then in turn pressed against the chuck, still in rapid revolution, the friction from which again softens and renders the cement adhesive; with the friction still continued, the speed of the lathe is next very considerably reduced, to enable the position of the work to be quickly examined, both edgewise and for centrality. If untrue in either direction the work is at once adjusted before the cement cools, and in a minute or so after the hand is withdrawn or the lathe brought to rest, the cement becomes entirely set and holds the work sufficiently fast for turning. The adjustment for center may be obtained more exactly when required, by means of a fine wire placed in the center of the chuck, entering a hole made in the axis of the work, it is then

only necessary to examine the truth of the work edgewise. The turner's cement effectually sustains the ordinary resistance to the turning tool, but it cannot withstand a sudden blow or jerk, a little care not to take too heavy a cut therefore is alone necessary; the work is readily removed by a slight blow on its side, or by the edge of a tool thrust between it and the chuck.

Work in both wood and ivory, is constantly fixed upon the *Wood surface chuck* by ordinary joiner's glue, and this method is in every respect preferable, except that it requires time, not being instantly available like the cement; but when several pieces are required, they may be generally mounted upon as many chucks at one gluing. The contact between the two is intimate and consequently truer, the position can be more deliberately adjusted, and the hold is so secure that the work is often with difficulty removed from the chuck. Their separation is assisted by a piece of thin paper placed between the two surfaces when glued together; the insertion of a thin tool or the blade of a knife then splits the paper and detaches the work without risk of accident.

Gluing the work upon the wooden surface chuck, is constantly resorted to for slabs of wood and ivory, both in plain and ornamental turning; for the latter, in which flat pieces are frequently pierced or cut into various figured outlines by revolving drills or cutters, this practice is adopted both for the solid support obtained, and also that the point of the tool may cut through the work into the surface of the wood chuck, without itself receiving damage or splintering the under surface of the work. The piece of paper is sometimes interposed, but it is not usually employed with the more delicate of these works in ivory, which are detached by standing the work and chuck in a shallow vessel of cold water until the glue dissolves.

Wood, ivory and some light metal works, are also fixed to the wood surface chucks by ordinary joiner's screws, passing through holes made in portions of the work that will be subsequently hidden or removed; if the work have permanent apertures the screws may be passed through them, small metal washers of different widths being placed beneath their heads to bear upon the work. When the entire surface of the work has to be turned, the screws may sometimes be placed in

from behind the chuck and allowed only to partially penetrate the work. In addition, all the various methods of fixing metal work, central or eccentric, described for the metal surface chuck, may be copied for wood turning upon the wooden surface chuck; only, the apparatus required is less strong, and is otherwise modified by the difference of material in both chuck and work. Instances of the further employment of the wood surface chuck, for the production of eccentric and other turned forms used for ornament, will also be found among the examples of combined plain turning.

Thin metal works are frequently cemented upon metal surface chucks. The cement used is made of a mixture of rosin and beeswax, usually without other ingredients and in the proportion by weight, of three of the former to one of the latter, melted together. The chuck having being first warmed, a thin layer of the cement is poured on the face and spread level, the work is then adjusted in position, and both it and the chuck equally heated to remelt the cement. Plates and pieces

Fig. 305.

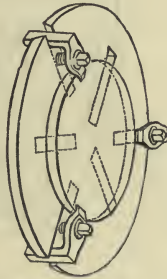
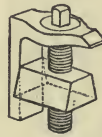

Fig. 306.



of metal of less size than the surface chuck, may often be sufficiently firmly cemented to it and with more accuracy, by applying the surface of the work directly to that of the chuck, and then pouring the hot cement in the angle around the margin of the work; or, the cement may be melted into the angle by a tinman's soldering iron. Metal works of moderate size that are thicker, or require a more secure hold than that afforded by cement, are generally attached to the metal surface chuck by soft solder, introduced between the two *cleaned*

surfaces. The whole has then to be heated to the melting point of the solder.

The *Surface chuck with clamps*, fig. 305, is employed for wood and metal; it has two sets of three radial mortises, in which the clamps are placed at any required distance from the circumference to the center. The clamps fig. 306, are formed of a nut filling the mortise, carrying a binding screw and rectangular clamp, which latter is retained, in both the vertical and horizontal positions, by the sides of the mortise and end of the nut. Fig. 305, serves for all diameters below

Fig. 307.

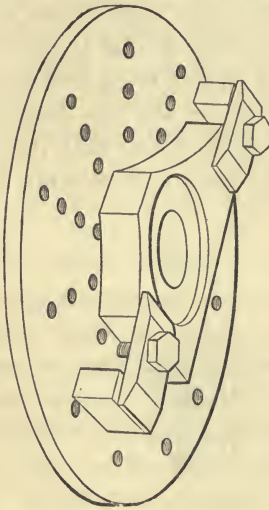
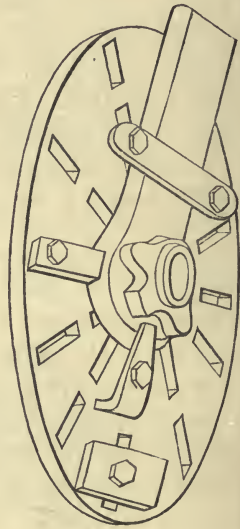

Fig. 308.



the largest the chuck will admit, and for all thicknesses not exceeding about one and a half inches; the work may be of circular or irregular shape, and as in all the surface chucks, it can be placed centrally or out of the axis of the lathe.

Surface chucks for metal turning are usually of cast metal, and increase in size with the strength of the lathe and the magnitude of the works for which they are employed; their clamps and fixing screws assume a great variety of shapes and dimensions, and these also frequently have to be expressly made to fix work of exceptional form. Works of moderate

size, are generally fixed against a plain surface chuck of brass, gun-metal or iron fig. 307 ; tapped full of holes to receive the screws. The clamps usually bear upon the work by one end, the opposite end being raised upon small blocks of metal or sometimes wood the end way of the grain, varied in number, fig. 311, to suit the thickness of the work. Sometimes the clamps are bent down or cranked, as in figs. 309, 310, which are convenient for turning several pieces of one thickness and dispense with the blocks. Clamps are also made for two bolts, either as straight bars, or with central apertures, figs. 308. 312, for works that have projections or require boring. The holes in all the clamps are elongated, to compensate the difference in radius in the position of the holes in the chuck ; should that be one-inch, the hole in the clamp is lengthened to give it one inch of play upon the bolt ; the clamps can then be placed at every distance from the center between one hole and another, that in holding the work they may only cover or block up from the turning tool the smallest portion that will suffice for the grasp.

The larger face chucks for the engineer are usually of iron,

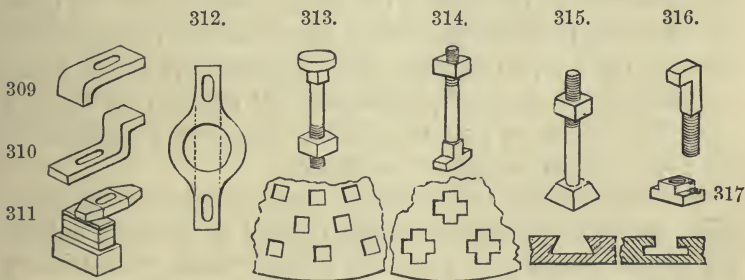

either with radial slots fig. 308, or else cast full of square holes, fig. 313 ; the bolts being forged square beneath their heads to fill the apertures and prevent them turning round when fastened. Similar bolts are used with large face chucks, fig. 308, the mortises upon which are also arranged in groups of four or six, for attaching wheels by their spokes. Surface chucks are occasionally cast with holes in the form of a cross, fig. 314, the oblong head of the bolt drops through the arms of the cross and when screwed up, catches against the angles between them. They are also made with undercut grooves

cast in the surface, as in fig. 315, or planed as in fig. 317, the grooves serving either for the heads or the nuts of the fixing bolts. Should the work contain suitable apertures, it is sometimes convenient to dispense with the clamps, fixing by the bolts alone passed through these openings, and holes are sometimes bored in the work for this purpose. Hook bolts fig. 316, with square shanks, are sometimes used within apertures and upon the arms of wheels, and for light purposes conveniently combine the clamp and the screw.

Attachment to the surface chuck by bolts and nuts, is generally ample for all works executed in the foot lathe, and also for many of the larger and heavier works that require more powerful apparatus. In more massive turning, from the great strain exerted this method of fixing is frequently insufficient; in such cases in addition to the clamps it is usual to employ solid stops, placed against arms or other suitable parts of the work. Plugs are driven into the square holes for this purpose, or blocks are fastened on the surface by screw bolts and nuts from the front or the back of the chuck, as in fig. 308; if these do not actually touch the work, small wedges are driven in between the two, so that the whole resistance to the tool may be sustained by the stops, the screws and clamps only holding the work in contact with the chuck. Screw stops similar to fig. 291, are also sometimes employed.

Works in which two or more surfaces, recesses or other parts, are required either exactly parallel or at right angles, are executed with ease upon the surface chuck, provided the latter be true, and the work be fixed upon it in actual or relative contact. For example, in boring or turning holes at right angles to the surface referred to the chuck, as in the pedestal of the slide rest fig. 308; or in turning shafts or studs, as in the radial arm, fig. 288, the several relations of these parts, whether they be central or eccentric to the general axis of the work, are at once assured without any doubt as to accuracy.

The variety of work to which the surface chuck applies, occasions some difference or choice of manner in which it may be fixed; and in addition to the methods already referred to,

the following expedients may be employed. The surface and the two edges of a ring, cannot all be turned at one time when fixed by clamps, which block up a portion of the work from the tool. The ring may be first fixed from the outside, while the inner edge and a portion of the surface are being turned; a second series of clamps bearing upon the finished surface is then fixed from the inside, *after which* the outer clamps are removed, the outer edge and the remainder of the surface can then be turned exactly concentric with the portion previously finished. All the three surfaces can be turned at one operation, when it is possible to drill and tap three or four holes in the ring, to attach it by screw bolts too short to project through it; the work being reversed to turn the other face. Chucks with radial mortises, fig. 308, are convenient for this purpose, and should the ordinary bolts be too long, they may be temporarily shortened by placing washers beneath their heads at the back of the chuck.

The correct central adjustment of the work may sometimes be attained, by a thin piece of wood fixed upon the surface chuck by screws or otherwise; this is turned away to the exact diameter to fit within the work, which is then fixed by the clamps. This method, which is employed only for accuracy upon the strong metal surface chuck, copies the constant practice in wood and ivory turning; the piece for the central adjustment is frequently fixed upon the wood surface chuck, while in the smaller examples the plain wood chucks, the chuck itself is turned away to leave the central projection to adjust, and in their case, to hold the work also. Temporary wooden beds of greater thickness, are used to chuck the irregularly formed pieces met with in machinery. Many of these can only be fixed by cutting out recesses in the bed to admit projecting parts, that some level or comparatively level plane in the work, may be placed in contact with the wooden bed and in that manner referred to the face of the chuck.

The holes and bearings in the sides of frames or parallel plates, to receive pieces for their connection, or for the support of axes and spindles, are conveniently bored upon the wood or metal surface chuck. The sides of the frames are sometimes marked and chucked separately, or they are pinned together, and drilled as one thickness, or else for pivots, the two sides

are sometimes attached as in their permanent shape, and the whole frame chucked as if it were a solid block; the pairs of holes being then bored out with a long drill that will extend through the two. When the interval between the two plates is too wide so that the guidance of the drill becomes uncertain, the sides of the frame have to be pierced at two separate chuckings. A pin is fixed in the center of the chuck and turned exactly to fit the hole already made on the one side; the frame being reversed, the pin enters this hole which is thus exactly central, causing the hole then bored in the opposite side of the frame to be in the same axis. Should the pillars or connections terminate as screws or otherwise projecting beyond the sides of the frame, a parallel piece of wood or metal formed with corresponding recesses is interposed, that the side of the frame may lie solidly and exactly parallel with the face of the chuck.

A series of eccentric apertures at a common distance from a center, as in the collar plate fig. 128, is turned by means of a pin or stud fixed in the surface chuck, at the same distance from its center as the radius of the eccentricity required. The stud fits a central recess in the work, which is turned round and clamped to bring the position for every hole successively opposite the axis of the lathe. Eccentric pins are also temporarily fixed in the surface chuck to assist in turning studs, holes or recesses in exactly similar positions, in several duplicate pieces. Rectilinear adjustment of the work, may be greatly assisted by fixing it in contact with a slip of wood or metal, also fixed upon the face of the chuck, while sometimes a slip is used on either side of the work to form a groove; the slips are employed with or without the pins, for turning a series of apertures in a straight line, the rounded ends of slots, and many parts of models and machinery. In turning portions eccentric to the general axis of the work, the eccentricity of the latter places the chuck out of balance, and its equilibrium then frequently requires restoring, by means of a block of lead or some sufficiently heavy body fixed to its face, necessary to attain smooth and equal turning, and shown by the examples figs. 308 and 324; the driving band is generally removed when the counterpoise is fixed in position, in order that its exact effect may be ascertained.

Work which does not present a plain true, surface from projections, irregularity of shape, from the casting being in winding or from other cause ; is propped or packed, by thin pieces of metal or hardwood, until it lies level on the surface chuck. So far as possible, the packing is placed beneath or close to the screws and clamps, and even then the process requires considerable care, that the fixing may not bend the work. Should that occur, the subsequent removal of the pressure allows the material to return to its natural tension, which deteriorates the truth of the surfaces that have been turned upon it. Should the surface chuck be weaker than the object to be turned, it may itself bend instead of the work, or the effect may partly result in each of them. The risk of error in fixing such work, is materially reduced when the casting is provided with projecting portions, also cast in the solid, in addition to those intended to be permanent ; these are subsequently cut off from the finished work, but for the time serve as feet, that the work may stand upon the surface chuck without the necessity of packing. Previously to clamping, the extremities of all the projections or feet are corrected to truth, to bear equally upon a planometer, or in its absence upon the surface chuck itself.

A further and inherent source of error in large or thin castings, arises from the alteration in form these are found to pass through, while under the operation of the tool. Owing to its more rapid cooling, the exterior of the casting to a slight depth is both harder and in a condition of greater tension than the interior of the mass, and when this outer skin is removed by the tool, some change of form is almost certain. Thin works are especially liable to alter, and none can be said to be entirely exempt ; but the more rigid the castings, the more uniformly they have been cooled, and the less the extent of surface to be removed, the smaller will be the risk of error from their elasticity. The difficulty can only be successfully overcome, by cutting away the outside from all the parts intended to be worked ; after which but little further alteration in the material need be expected. This may be done with the chipping chisel and file or in the lathe ; if in the latter, the work is afterwards rechucked with additional care in the pack-

ing and the surfaces turned a second time, when a much truer result will be attained.

UPRIGHT CHUCKS.

Rectangular and other pieces, the edges at angles to the principal planes of the work, and projections or recesses upon these edges, are turned with the work fixed against upright chucks; generally species of surface chucks, in which the face or the piece holding the work is no longer at right angles to the axis of the mandrel, but either parallel with it, or at the appropriate angle required. The *Upright* chucks used for turning small rectangular and other objects in wood and ivory, and sometimes for light works in metal, are very generally made from the plain boxwood chucks; the material of which

Fig. 318.

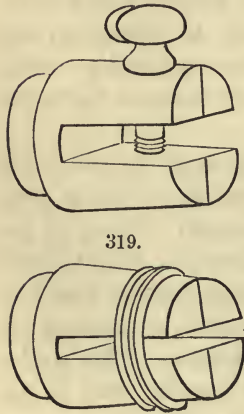
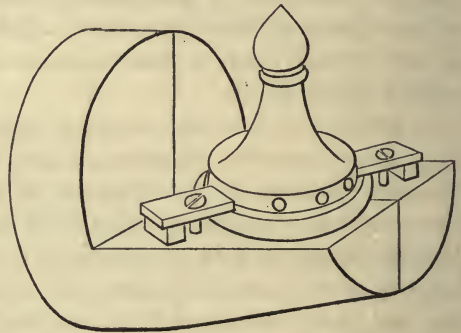

Fig. 320.



has sufficient elasticity and does not indent nor damage the work. Fig. 318, has a long diametrical gap closed by a thumb screw, and is an enlarged copy of one of the small screw head chucks used by the watchmaker; the surface is marked with a diametrical line at right angles to the gap and the work is adjusted in position by the fingers; the width of the opening may be contracted, by inserting loose plates of wood or even cardboard when one chuck serves for many thicknesses of work.

The chuck is rendered more elastic, when the lower end of the gap is enlarged, as in fig. 769 ; but this sacrifices a portion of its solidity, nevertheless such chucks are very suitable to some light works. Fig. 319, is more convenient from being closed by a ring, as in the ordinary spring chucks, which thus avoids the obstruction caused by the screw and allows greater variety in the form of the work. From the absence of the screw this chuck would be selected to turn or bore the two end surfaces of the half of a ring, the one end of which would project through the side of the chuck, when the other is adjusted to the center for turning. Shorter arcs, such as those in which one end surface is radial for attachment, and the other end surface at right angles to it, that a pair may form the gothic arch, or others, in which both end surfaces of each piece of the arc are turned or bored at an angle, to combine in a polygonal instead of a circular form, cubes, squares and flat pieces, are among the objects also held by this chuck.

Upright wood chucks have the advantage of being easily made to meet the requirements of particular works as they arise. The sides of the notch are formed by two saw cuts, made through lines marked parallel with diametrical lines, struck on the surface and sides of the chuck, they are afterwards finished flat and to the width with a file ; the relative and individual truth of the side and bottom surfaces of the gap are more readily attained, if during their formation the chuck be mounted on a *square* stem, provided with a copy of the mandrel nose, which stem may be held in the vice. The ring upon fig. 319, may also be provided with a screw, as in fig. 270, or replaced by the clamp, fig. 756, and the permanency of all these chucks is much increased by the addition of a brass flange, as in fig. 260.

If the one jaw of fig. 318, be entirely removed, the remaining surface and the central screw, will represent the wood upright chuck, shown by fig. 320 ; this chuck is used for turning portions of the edges of pieces that either cannot be readily admitted, or that are too large for the gap of the former. The work is received and moved round upon a central pivot or screw, placed exactly upon the axial line marked on the chuck ; and it is fixed to the surface after each successive change of position, by screws and clamps placed around a part of its

margin, or passing through some part of the work into the surface of the chuck. The arrangement is equivalent to an ordinary wood surface chuck revolving upon its edge; its surface parallel with the axis of the lathe, but sufficiently removed from it, to allow for different thicknesses in the work. Thin parallel pieces are placed between the surface of the chuck and the work, to raise the center or any other line upon the edge of the latter, exactly to the axis of the mandrel; as for turning the flat face of a square or polygon, or for sinking and screwing recesses for the attachment of arms or ornaments, as in some of the more elaborate examples of plain turning. Another variety of chuck used for these purposes, figs. 753—755, together with its application, is described in the last chapter.

When the recess or part to be turned, stands at an angle to the face or edge of the work, the surface of the chuck has to be inclined to the axis of the mandrel at the appropriate

Fig. 321.

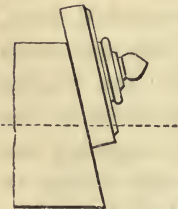

Fig. 322.

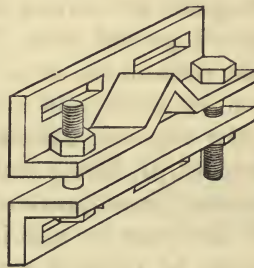
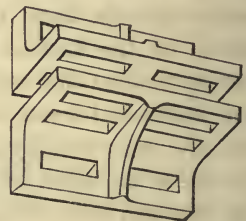

Fig. 323.



angle; the work being fixed to the surface in the same manner as before. Packing to raise the work is not then always necessary. The entire surface of the chuck, indicated by the diagram fig. 321, stands at an angle to the axis of the wooden cylinder from which it is formed, and the work may therefore be fixed higher or lower upon the sloping face, so as to place any point upon either its edge or surface, axial. The exact position is readily found after the work has been lightly clamped in about its neighbourhood, by then shifting the work upon the surface of the chuck, until the center of the portion to be turned is adjusted to the point of the popit head. The

position of the central pivot or screw upon the sloping face of the chuck, necessary for turning a series of apertures at an angle around one common center, is determined after the work has been adjusted in the manner just described; a mark is then made through the main axis of the work on the face of the chuck, this determines the position of the hole for the pivot in the one direction, the other direction, being the diametrical line of the chuck. The upright chuck with sloping face may be made at all angles from 90° downwards; but in some cases when the required inclination is small, the chuck may be dispensed with, by using inclined packing upon the ordinary surface chuck.

Similar forms in metal are turned by means of analogous appliances, which are usually of cast iron, temporarily bolted down to the surface chuck. The *Rectangular vice*, fig. 322, is employed to carry small pieces of various thicknesses, placed either parallel with, or perpendicular to the face of the surface chuck. The angle in the upright side serves for prisms and other solids, and both sides may thus receive any formation required to enable them to hold particular shapes; sometimes one half only is used, its vertical face is then pierced with holes or slots for the bolts and clamps to fix the work. The upright face is inclined, as in fig. 323, to carry work at an angle. The work may occupy any position upon the upright block, and this may be bolted down towards the center or the margin of the chuck according to circumstances, and by these methods many flat, rectangular, and other works in metal may be turned upon their sides and edges with considerable facility. The rectangular fixing blocks or tables used by the engineer for turning large work, are cast of all dimensions with both faces full of square holes, tapped holes, or slots; these also are employed either singly or in pairs and are fixed with the bolts and nuts in common use with the surface chuck; a counterpoise is very generally required with all the above chucks.

Compound forms that contain portions turned from two or more faces, may be mounted and turned upon the surface chuck by a fixing piece A. fig. 324; frequently, with greater convenience and accuracy than by chucking the work upon its different axes between centers, upon double screw chucks

or otherwise; the comparative truth and facility of the different methods, largely determining the particular mode of chucking selected.

The square fixing block A. has a central screw, a copy of the nose of the mandrel, to carry the work, and provided this screw be exactly parallel with the sides of the block, it carries any of the chucks at right angles to their ordinary position. The work may thus be commenced upon the mandrel, and all the turned portions upon the axis 1.—1. completed in the ordinary manner; the chuck being then placed upon the fixing

Fig. 324.

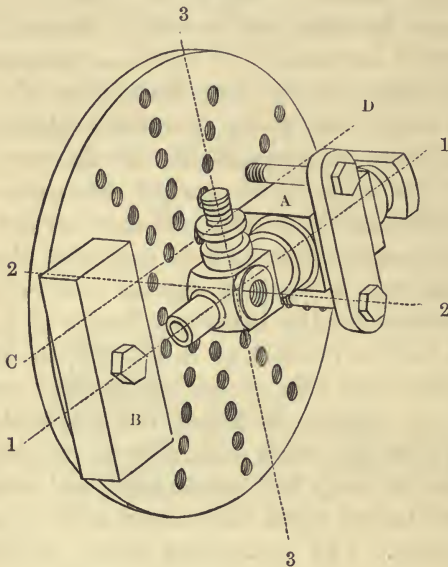

block and the latter clamped on the surface plate, plain surfaces, cavities, screws and projections may be turned upon the sides. The relative angles of the work, agreeing with those of the guide block, the three axes 1—1. 2—2. 3—3. will necessarily be at right angles to each other if the block be cubical; this shape, or any other arrangement can be given to the plain sides of the block with comparative facility and thence transferred to the work; which latter, would be far more difficult to shape had the measures to be derived from its own small irregular or curvilinear surfaces. Similar square, hexagonal

and other blocks, may be employed on the surface chuck in wood and ivory turning, for the production of corresponding pieces used for plinths and other purposes; and the fixing piece A., in common with some other methods of chucking previously referred to, also serves for the exact repetition of several copies. The precise replacement of the chucking piece when used with the latter object, may be ensured by stops, while one or more slips, also fixed to the surface chuck on the line C. D. or in other positions, will ensure its rectilinear adjustment.

The work will possess the same degree of perfection as the guide, provided the depth to which the tool is allowed to cut, be alike upon every face of the solid. This may be readily ascertained by the turning square fig. 427, or by a template or gage cut from a piece of sheet metal, measuring the distance from the face of the work being turned to that of the surface chuck. The flatness of each surface turned as also the unbroken sharpness of its angles, is rather more difficult of attainment, for a great portion of the cutting being intermittent the corners are liable to splinter unless the tool be both exactly presented and rigidly held, which somewhat interferes with freedom of manipulation. Very many such forms in wood and metal however, may be successfully accomplished by hand turning; the surfaces that are across the grain in the former, being turned prior to those with the grain, but these and others presenting greater difficulties, or of large size, are all turned with ease and precision, when the tool is placed under the mechanical guidance of the slide rest.

CHAPTER VII.

THE ELEMENTARY PRACTICE OF SOFTWOOD TURNING.

SECTION I.—INTRODUCTION. POSITION FOR STANDING.
TREADING THE LATHE. VELOCITY GIVEN TO THE WORK.

THE art of turning in softwood produces numerous useful and elegant results for domestic, personal and manufacturing purposes; it requires comparatively few and simple tools, but affords considerable scope for ingenuity and skill, in suitable design and in its application to the material, and in the use of the tools. The devotion of a little time and care to acquire a moderate proficiency in this branch of the art is very advisable. The acquisition of a sufficient mastery in the management of the gouge and chisel being especially advocated, as it not only greatly simplifies the use of the other softwood tools, but, the confidence and facility thus attained, remove many difficulties in the ordinary practice of hardwood and metal plain turning.

For elementary practice with the softwood tools, the production of the simple planes and solids, viz., the cylinder, surface and cone, the internal cylinder, surface and cone, and subsequently, the sphere and internal hemisphere, are offered as sufficient types of procedure. The manipulation acquired in turning these forms, may be readily applied to any others, more complex in shape or detailed ornament; for such forms, however elaborate, may always be resolved into combinations of the simple primary figures named. Examples of the production of combined forms, shown by some objects in ordinary use, together with some more elaborate works in the soft woods, will be found in later pages.

It should be premised, that in all the branches of the art of turning, as in all other handicrafts, there exist many variations of practice; to suit the convenience of the operator, the conditions of the material and the tools available, or, arising from peculiarities of local habit. These variations are not generally

of sufficient importance for detailed notice, and the observations in this and following chapters, are intended rather to meet the ordinary requirements of the amateur turner, than to supply an exhaustive description of all the various methods that may be available in hand turning.

The position in which the operator stands when working at the foot lathe, is very little influenced by the material, but varies with the form of the work upon which he is engaged. When the work is of the cylindrical character; he stands square, facing the lathe bearers, the body held fairly upright supported on either leg held rather rigid at the knee and ankle joint; the toes pointing outwards and an inch or so distant from the front rail of the treadle. The ball of the other foot rests on the front edge of the treadle, the toes also pointing outwards, so that the heel of the treadle foot and the hollow of the supporting foot are about opposite. The occupations of the two legs are exchanged from time to time, and in the majority of cases, it is quite unimportant upon which leg the body is supported. The tool however being held in the right hand, it becomes stiffened and as it were braced together with the entire right side, when the body stands on the right leg; and that position, is therefore naturally adopted for all cuts demanding especial care and exactness.

With work approaching the surface character the same general position is employed, but the body is slightly turned to be more in face of the work, and stands at an inclination of about 45° to the bearers. This is often insufficient for surfaces and internal work; the operator then stands on the right leg, facing the surface and at right angles to the bearers leaning against them by the right hip, the right foot parallel with the front rail of the treadle, the left leg crossing over the right shin in moving it.

To set the lathe in motion, the driving band is taken between the left finger and thumb and pulled downwards, the foot at the same time being placed lightly on the treadle, without exerting any active pressure. The consequent partial revolution of the fly wheel causes the bend of the crank to rise and lift the treadle, until, the crank having passed over the

vertical position, the treadle commences to descend, at which instant the pressure of the foot is first exerted upon it. The descent of the treadle enforced by the foot, continues the revolution of the fly wheel, causing the treadle to rise again to be again depressed by the foot and so on. In keeping the lathe in motion or in *treading* the lathe, the regular intermittent pressure given by the foot is always commenced gently, gradually made more forcible during the first part of the descent of the treadle, and as gradually reduced towards its termination: at which and during the upstroke, the pressure is entirely relieved, although the foot still remains in its place. The actions described are readily and almost instinctively acquired. The foot generally remains continuously on the treadle, but occasionally when the lathe has been set in sufficiently rapid motion, it may be removed from it, should the operator desire to stand for a few moments upon both feet, to be perfectly steady while making a cut requiring more than usual precision.

The pace at which the treadle is moved, in other words the velocity given to the fly wheel and conveyed to the mandrel, necessarily varies in all cases with the diameter of the work; for should the revolutions of the mandrel remain at one constant rate, the surface velocity of the work will increase in the ratio of its diameter at the point under the tool. Therefore to attain the uniform surface velocity most suitable to the material and the action of particular tools, works of small diameter require driving faster than those of large.

This necessity is equally felt when the form of the work combines portions greatly differing in diameter in one solid, or, upon the simple plane or surface, upon which the surface velocity gradually diminishes from the circumference to the center. In the latter case, the driving band being arranged for a speed suitable to the medium diameter of the surface being turned; the revolutions of the mandrel may be so varied, as to attain a sufficiently near approach to uniform surface velocity in the work, by treading the lathe a little faster or slower, as the tool approaches its center or circumference.

The same variation generally suffices for cylindrical work of varying diameter; although it may be sometimes convenient,

to shift the driving band to different speeds, suitable to the different diameters of the work, as these are successively turned. Large diameters of all materials force the operator to tread the lathe at a relatively very reduced speed, necessary in turning iron, among other reasons, for the preservation and correct action of the tools, but, principally requisite in softwood turning, the other extreme, to avoid too great bodily exertion.

Softwood, in comparison with hardwood or metal turning, requires the highest rate of speed, and it may be said, in respect of the lathes described in this volume, that when employed for works up to two or three inches diameter in softwood, it is hardly possible to employ too high a velocity. The driving band should then run from one of the larger grooves on the fly wheel, to one of the smaller on the mandrel pulley. It may occupy a pair of grooves of medium size, for work from three to six inches diameter; while for larger, a still less speed is desirable, in order that the work may not become inconveniently laborious.

SECTION II.—EXTERNAL TOOLS. LEVERAGE. POSITION OF THE
GOUGE AND CHISEL ON THE CYLINDER. CALLIPERS.

The general principles guiding the forms, the shapes and angles, and the action of the cutting edges of all turning tools, together with illustrations of those most generally in use, are given in Chapter XXIV. of the second volume of this work; that should be perused, but various points there mentioned will be adverted to, so far as may appear necessary, in this and succeeding chapters. It is not proposed however to enter a second time upon the processes and manipulation, by which the grinding and setting of all the different turning tools are accomplished, these subjects having been treated at length in the third volume, to which the reader is also referred; but it will be convenient to note, that the cutting edges of all the softwood tools are ground to an angle of from 25° to 30° .

The *gouge* and *chisel*, shown on the face and in profile figs. 325 to 330, are the tools principally used for external softwood turning, they vary in size, according to that of the work upon which they are employed, and range from about one eighth, to about two inches in width of blade, and are of proportionate thickness. These and the other softwood tools, are

handled in great measure according to their size, the smaller in short and the larger in long handles ; the complete tools so handled, measuring about 8 to 13 inches and 15 to 24 inches respectively, in total length. The medium and most useful size of the gouge, is from half to threequarters of an inch wide, and that of the chisel, from threequarters to one inch wide ; which tools in long handles, measure from 14 to 20 inches in total length.

The turner's gouge is ground on the convex face only, and obliquely to its sides or edges, to give it an elliptically formed cutting edge, and to obliterate the sharp corners that would be formed, were the tool ground square across the end in the

Fig. 325. 326. 327. 328. 329. 330. 331. 332. 333. 334.

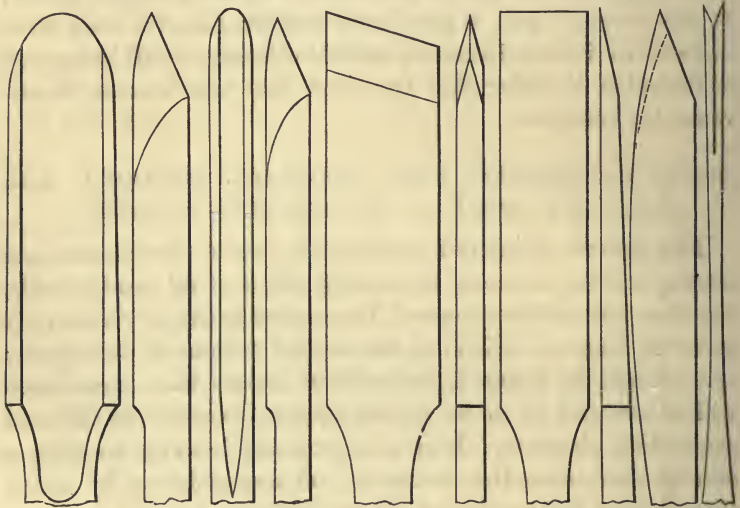

manner of the carpenter's gouge. The elliptical cutting edge is necessary, to prevent the corners catching the work, and to permit the gouge to occupy and be moved in less space, in turning small curves and mouldings ; for which latter reason, the shape is perhaps carried to a rather greater extent with the smaller sized tools.

The cutting edge of the *chisel*, for the sake of greater convenience in holding the tool to the work, stands obliquely, forming angles of about 70° and 110° with the parallel sides of its shaft, fig. 329 ; and it is ground with a bevel on both faces,

fig. 330, to form the cutting edge in the center of its thickness. Occasionally it is ground square across, but the oblique edge is far more general and convenient. A tool of the same section, is sometimes ground square across, but with a single bevil on the one face only, figs. 331. 332, like the carpenter's chisel; it is then called a flat tool and has appropriate uses.

The *parting tool for softwood*, figs. 333, 334, is generally about one eighth of an inch or less in width at the cutting edge, the widest portion of the blade, which, to obtain clearance in the work, tapers gradually thinner towards the thicker stem; it is comparatively of considerable depth or thickness. The cutting edge is divided into two points by an angular groove upon the face, and is ground with a plain bevil upon the under side.

All the hand turning tools may be considered to contain the principle of the lever; their cutting edges are at their shorter ends, the rest on which they are supported is the fulcrum, and their handles or shafts are the longer ends. The command obtained over the tool, in other words the power by which it is controlled and made to penetrate the work, greatly depends as in all similar levers, upon the relative lengths of the two ends. This, can be varied at will with the turning tool, by the position given to the fulcrum, the movable rest, and that of the hand on the shaft of the tool. So that it follows, that the more closely the rest is placed to the work, and the more nearly the hand approaches the extremity of the handle, the greater will be the power obtained, and the less the exercise of strength required for the direction of the tool.

The long handle is necessary to the larger softwood and other tools; among which many have to considerably overhang the rest by their cutting ends; on the other hand it asserts so great leverage, as to require using with caution. Otherwise the edge of the tool may be easily forced into the work, both deeper and faster than it can possibly cut fairly, when it will tear or destroy the work, or perhaps wrench it out of the chuck. The undue force thus exercised by the tool upon the work, is also disagreeably felt by a corresponding wrench to the wrists and arms of the operator.

POSITION OF THE GOUGE ON THE CYLINDER.

In turning the softwoods, the gouge is usually held grasped firmly by the left hand, which is wrapped around the blade a short distance from the cutting edge, the knuckles uppermost and the fingers beneath; the end of the handle is held in the right hand, which is kept pressed close to the side of the body. The convex back of the tool is pressed on the rest by the left hand, the tee being placed sufficiently high for the shaft of the gouge to lie at about the angle shown by the dotted line fig. 335; when its *bevil* or cutting edge, lies nearly as a tangent to the circle of the cylinder under formation.

When the cutting bevil is exactly a tangent to the circle, there is no cutting action, its position then being really that at which the tool has ceased to cut; but if, while the bevil is thus in contact with the work, the handle of the gouge be slightly raised the leverage causes the tool to penetrate, because the edge then assumes the position of a tangent to a circle slightly less in diameter than that of the work. If the tool be then held perfectly still at this slightly differing inclination, so soon as the work has made one revolution, it will be reduced to this new circle, when the edge of the gouge will again become exactly a tangent and cease cutting; to be again made to cut by another slight rise of the handle and so on; the elevation given to the handle, regulating the thickness of the shaving. The gouge therefore materially assists in finding its cutting position, its bevil is always laid to the work just out of cut, and is then brought into work by slightly raising the handle. The two movements should be considered and practised as distinct, but the intuitive feeling that the gouge is correctly placed to the cut is rapidly acquired, after which, they are made almost involuntarily and as it were simultaneously.

Figs. 335 to 337, represent in three views, a cylinder carried by the prong chuck, the position of the rest and the positions assumed by the gouge, in the course of the reduction of the work from the rough block to the cylinder. The latter left roughly rounded from the paring knife, it is presumed, has been adjusted to run fairly true when supported between the prong chuck and the point of the popit head, by one of the methods already described.

In roughing or first turning the work true or concentric, the gouge has to be held and pressed on the rest with considerable firmness, with the handle held tightly and closely against the side; in order that every cut now taken, so far as its separate width and depth extends, may at once reduce the work to circular truth. If on the contrary, the gouge be insufficiently held, it will oscillate with every revolution of the irregular surface of the cylinder, tending to perpetuate instead of reducing its errors. The first cuts upon the irregular cylinder are taken with the gouge held in the manner already described, but also twisted by both hands, until the blade lies on the rest on its right side near the edge, fig. 337; the shaft, held at about the vertical inclination, fig. 335, is also inclined to the right horizontally, fig. 336. The first cut is made about half an inch from the end of the cylinder, and so soon as the gouge has cut a complete circle, it is gently and steadily pushed to the end of the work by the left hand, at once reducing this small portion to truth. A second cut is now

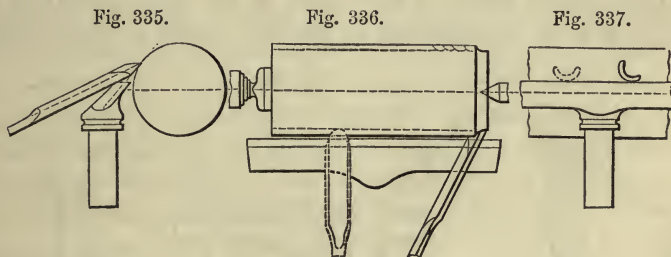

made at a little distance from the first, into which it is merged by the same means, and so on for the whole length of the cylinder; which, by the repetition of cuts taken in immediate succession, is reduced to an irregular but concentric figure. Should the work be very irregular, it may not be rendered concentric by one such series of cuts, and two or three would be taken, dividing the work to be done; the first series cropping down and partially reducing the irregularities, which would then completely disappear under the second or third.

The various circles formed by these roughing out cuts, are then made uniform in depth, and into the straight line required by the cylinder. The gouge is held after the same manner,

but at right angles to the work, and lying on the rest on the center of its back or convex side, shown by the dotted positions figs. 336. 337.; it is slowly traversed backwards and forwards from end to end of the rest, and produces a moderately even, but rather fibrous surface on the work. The tool is made to travel at an equal pace, that it may cut an equal amount all along the cylinder, and in a straight line upon the rest parallel with the axis of the work, to prevent that becoming taper, hollow, or rounding in respect of its length. The first few traverses of the tool, are sufficiently guided by the eye, after which the work may be tested with the callipers, to find those parts which require further reduction, previously to using the chisel. The diameter of the work, having been reduced by the shavings removed by the gouge, the rest has now to be placed a little closer, to reduce the increased interval between its edge and the work.

POSITION OF THE CHISEL ON THE CYLINDER.

The cutting action of the chisel is the same as that of the gouge and its management is similar, except in some details

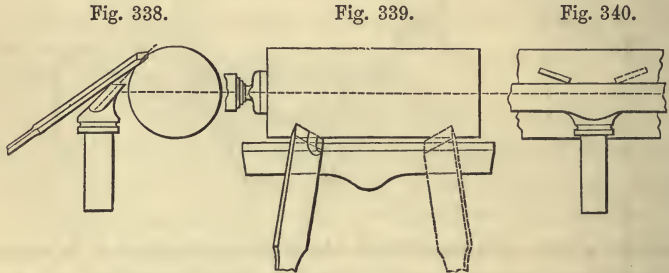

due to the difference in form of the two tools. The positions on the cylinder, are given by figs. 338—340. The chisel is held with the left hand folded round the blade, not far from the cutting bevil, the fingers beneath and the knuckles above; it is presented to the work with the shaft of the tool at a small horizontal angle fig. 339, and instead of lying flat on the rest, is tilted on the under corner of one side. It is made to traverse the cylinder, first from left to right and is turned over and tilted in the other direction, to proceed from right to left; the obtuse angle of the cutting edge invariably leading.

The chisel cuts with avidity, and if the entire width of its keen edge be presented to the cylinder, or any object longer than itself, the tool buries its edge in the work and is unmanageable; while the corners roughly ploughing up the fibres of the wood, entirely prevent any attempt to traverse it. For this reason the tool is tilted upon one corner of its side, which, with the oblique form to which it is ground, together with the horizontal angle at which the shaft is held on the rest, causes the cutting edge to lie as an oblique tangent on the work. The tool is in contact only at one point, situated about a third up the cutting edge from the obtuse angle, with both its corners entirely free and disengaged from the work. Although the cutting edge is ground obliquely, the chisel does not attain a sufficient angle, unless the tool be presented to the work with the shaft at an horizontal angle, fig. 339, and an equal cut, or thickness in the shaving removed, depends upon the horizontal angle and the vertical angle or tilt, being both equally maintained during the entire traverse of the tool along the cylinder.

The form of the chisel very considerably assists in finding its correct cutting position. In first applying the tool to the work, a portion of the flat side of the blade beyond the grinding, is first laid upon it, and the tool is then gently drawn towards the operator, during which time, it is made to assume both the horizontal and vertical angles. The right hand at the end of the handle, previously free of the body, arrives at its place against the side, at the same moment that the chisel has been drawn sufficiently towards the operator for it to rest on the work by its cutting bevil. No cutting takes place, until the handle is gently raised; when the edge assumes the position of an oblique tangent to a circle of slightly less diameter than that of the work; the shaving resulting, being of a thickness equal to the difference of radii between the two circles. The motions separately described, as required to place the tool in the cutting position, are quite the reverse of those employed for most turning tools. In practice, they follow each other rapidly and are nearly simultaneous, when, as the chisel is laid upon the work and drawn towards the operator, the bevil appears slightly to stroke the work, before it cuts the shaving.

The first traverses of the chisel remove the marks left on

the cylinder by the gouge, the tool is then made to travel from end to end of the work, at an even pace and pressure, that it may remove an equal quantity all along it. The equality or otherwise in the thickness and width of the shavings produced, serves as a guide to show whether the rate of traverse and the angular position of the tool, have been correctly maintained throughout. To a beginner, it is at first somewhat difficult to maintain the shaving uninterruptedly, but this, and a sufficient equality, are readily arrived at by a little practice. The cylinder when turned smooth is tested for parallelism; the callipers are used with more care, than when applied to the cylinder left from the gouge, and should be provided with a set screw fig. 341, to prevent their accidental displacement.

That portion of the cylinder having the smallest diameter, being ascertained, the callipers are fixed to that size and the whole cylinder reduced to it. The portions in excess are reduced by shavings commenced at the larger diameter, and made to gradually die away to nothing in the course of the traverse to the smaller; effected by gradually lowering the handle, to vary the tangential position of the tool, until it entirely ceases to cut. The callipers being frequently tried from time to time, to find when the reductions have been carried sufficiently far to leave the cylinder true or everywhere equal in diameter.

To obtain a delicate equal shaving, the entire length of a cylinder or cone, or for a fine shaving that must begin and end in nothing, employed to correct the work when that is moderately small in diameter, and not far from its true or finished line, the chisel may be held in a different manner with advantage. The left hand, the back uppermost, has the whole of the fingers placed from above lightly around the work, which revolves within them; the left thumb is firmly pressed on the flat of the chisel, upon or just beyond the grinding, so that the under bevil of the blade is pressed on the work and forced to assume the most accurate tangential position. The right hand is shifted from the handle up to the blade, which it holds lightly on the rest, having only to assist in maintaining the tilt and to prevent the tool falling away from the cut by any lowering of the handle. The right forefinger is then sometimes stretched out along the side of the chisel; the traverse

of the tool being much assisted by the left thumb, which aids by pushing the chisel along the cylinder, at the same time that it keeps it in accurate contact.

So soon as the gouge and chisel can be managed with tolerable facility, elementary practice may be continued by turning cylinders of lengths and diameters previously determined; the end surfaces being also turned flat, measured with the callipers and square. This requires more care, and may be taken as the first step in copying, the materials also not being wasted, but turned to account in being prepared to the cylindrical form for future use.

CALLIPERS.

The *Single Callipers* fig. 341, referred to as used for external measurement, are made of two thin plates of sheet steel jointed together at a center, the bows tapering to delicate points the

Fig. 341.

Fig. 342.

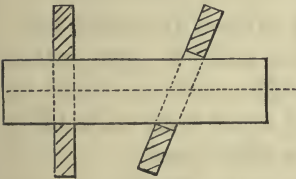
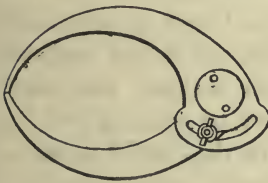

Fig. 343.

Fig. 344.



extreme ends of which are slightly rounded; when opened to the required measure, they are fixed by a screw and nut working in a circular mortise.

It is absolutely essential to correct measurement, that all callipers should be applied to the work held exactly square at right angles to its axis, that the entire thickness of their blades may bear upon the object measured. It is evident that if held otherwise than square, the blades can only touch the work by their opposite external corners fig. 343, when the

measure varies and is quite untrustworthy. The necessary elasticity of the callipers, if they be unskilfully used, may also be a source of error, as they are capable of being *forced* over a diameter slightly larger than that at which they have been set and are intended to measure. In testing the cylinder or in copying any object, the callipers are closed upon the work by the hand, so that the points may pass over the diameter measured without difficulty, but with a sensible touch; they are then fixed by the binding screw, and are afterwards retried at the same place, to see that fixing the screw has not shifted the points. They are used held rather lightly in the hand by the joint; the work in the lathe being brought to rest before they are applied to it. Although set so as to pass over just easily, the hand sensibly feels the contact between their points and the objects measured; the comparison of the one diameter with the other depending entirely upon the sense of touch, which unerringly detects whether the contact agrees or differs. As the diameters nearly approach each other in size in course of reduction, the nice appreciation of the touch is materially assisted by constantly referring the callipers to the original object, to again feel the degree of their contact, and then immediately transferring them to the work or copy, to feel for the same degree of contact also there. In the careful measuring required upon small and delicate works, more especially upon those of metal, the binding screw is often dispensed with, as inconvenient; the callipers are then made to open rather stiffly upon the joint, and for minute differences are closed by one bow being gently struck or tapped upon some unyielding surface, like the jaws of the vice or the lathe bearers.

The *Double Callipers* fig. 342, called by the French "maître de danse," have the bows made in one piece with straight legs on the opposite side of the center; both ends give the same measure, but externally and internally, so that when the bows are employed to take the measure of a solid object, the legs will just enter and gage the aperture to receive it. The *Double side callipers* fig. 344, give the same external measure at either end. They are used to measure the thickness of tubular works of a diameter too small to admit the ordinary form of callipers, and also to test the thickness of hollow cylindrical and other work, when from external projections, it is not possible

to separate the callipers from the work without opening them and so losing the measure. The one end free of the work, shows the measure taken by the other retained within it.

SECTION III.—POSITION OF THE GOUGE AND CHISEL ON THE SURFACE, BACK SURFACE, THE PLANKWAYS SURFACE, AND ON THE CONE.

The cutting bevils of the gouge and chisel, at the moment of cutting in producing the surface, exactly coincide with the planes they form, analogous to the manner in which they become tangents to the circle upon the cylinder; their cutting action is obtained, by presenting the bevil to the surface at an angle slightly greater than that of coincidence. Independently of this angular position, the bevil of the tool travels radially from the circumference to the center, exactly at right angles to the axis of the work. The blade of the gouge is held as before, but the right hand is placed higher up the body with

Fig. 345.

Fig. 346.

Fig. 347.

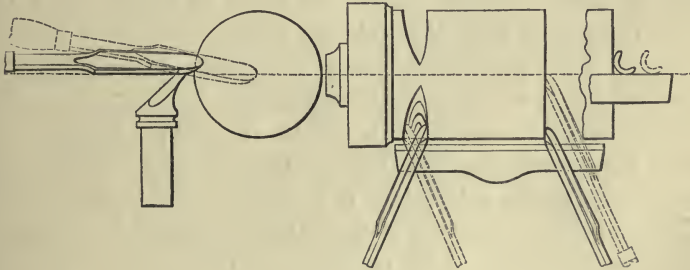

the knuckles against the side, the arm bent at the elbow; the gouge rests on its side fig. 347, with the cutting bevil nearly corresponding with the proposed surface. The tee of the hand rest is in the same position as for turning the cylinder.

The rough end of the cylinder not being at right angles to its axis, forms acute and obtuse angles with its sides; the first surface cut with the gouge therefore, has to be made at a sufficient distance from the end to be just within the obtuse angle, at once to form a continuous arris, to avoid intermittent action against the tool. It should also be remarked that the first cut with the gouge upon the surface, here referred to, is

generally made to a small depth, at the time of rough turning the cylinder, in order that the extreme end of the latter may be true and not interfere with the traverse of the tools upon it. The gouge held firmly with both hands and nearly horizontally, fig. 345, is thrust straight forward, and travels from the circumference to the center by the weight of the body pressed upon it; the handle being at the same time continuously raised against the side by the right hand, which gradually directs the point of the tool to the center, where, at the termination of the cut, it assumes the position shown by the dotted figure. The body also slightly sways to the right, as the cutting bevil following the surface to the center, causes the shaft of the tool to travel a short distance in that direction on the rest.

The accurate direction of the edge of the gouge may be much assisted upon surfaces of small diameter, and also as it approaches the center of those of large, if the tool be held in a slightly different manner. The gouge is still firmly grasped within the left hand as before, but the side of the hand is firmly pressed against the front of the tee, and the gouge is made to slide through the closed hand, as if through a tube. The left hand clasps the blade with either the knuckles or the finger nails uppermost, the latter position being sometimes convenient. Held in either manner, the gouge thus traversing the surface the end way of the grain, always lies on its side, when it cuts only by the center of its elliptically formed cutting edge. Should the tool become misplaced in the course of its progress, so that it lies on the rest less on its side and more nearly on its convex back, it becomes very difficult to hold; the side of the cutting edge being then almost certain to catch in the surface, to their mutual damage. It is not essential that the tool should travel from the circumference to the center at one stroke; its progress may be arrested and recommenced as often as may be convenient; indeed unless the surface be small, it is rarely possible to direct the gouge in an actually true straight line. At first the surface produced will be irregular, and with practice it is usually somewhat concave or convex; the tool has then to be reapplied, under the guidance of the straight edge or square, to reduce the portions they show to be in excess. The gouge

cuts square across the fibres of the wood and can easily be made to produce a surface that is sufficiently good for many small works, or for the hidden faces of larger, so as sometimes not to require the subsequent application of the chisel.

In turning the surface, the blade of the chisel is held as described for the cylinder, but, it is supported upright upon one edge, the shaft standing on the rest at a small lateral angle, fig. 349, placing the cutting bevil vertical and at right angles to the axis of the work. The chisel is presented to the circumference of the surface, held quite close to the end of the cylinder, sloping slightly upwards, as in fig. 348, or horizontal, or even downwards, as the acute or obtuse angle may be uppermost; the cut being commenced by a portion of the cutting edge, about one third distant from the lower angle. The tool is pushed forward and simultaneously brought nearly horizontal, the cut being terminated at the centre by the actual point of the lower angle. The acute or the obtuse angle of

Fig. 348.

Fig. 349.

Fig. 350.

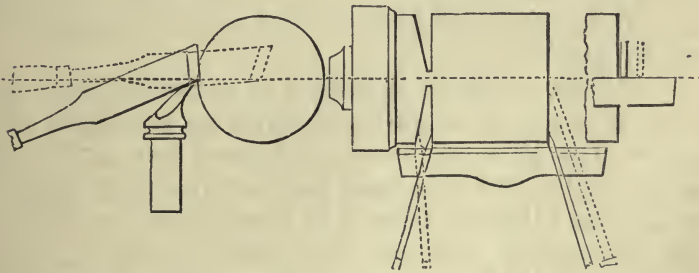

the chisel may be used uppermost, almost indifferently, as may happen to agree with the material, convenience, or individual habit. Surfaces upon the harder softwoods, such as beech and mahogany, especially when the wood is dry and well seasoned, are more readily turned with the acute angle below, but freshly cut and the softer woods, when it is above, as in the figure. The shaving takes the form of a thin disc, complete and bent up, or dished like a saucer, from the advance of the tool forcing it to creep up the outer bevil of the cutting edge. If however, it be attempted to remove a shaving of too great a

thickness, the disc is unable to bend out of the way, and it then completely arrests the advance of the tool.

Should the blade of the chisel be inclined towards the work by its upper edge, instead of being held precisely upright, the bevil wanders from coincidence with, and encroaches upon the plane of the surface it is cutting. The cutting edge, is then almost certain to catch against the arris formed by the surface and cylinder, which entanglement causes the tool to be irresistibly carried along towards the center, its upper angle, scoring the surface with a deep irregular screw line. The chisel is most liable to this accident at the commencement of the surface cut, when, it may be avoided, by holding the shaft of the tool firmly, exactly upright and at a small horizontal angle; making the first incision as if for an obtuse cone, the blade held in the direction of the chisel when turning the back surface, fig. 349, but much less as to angle. Immediately after which, continuing the cut and without removing the tool, the blade, still held exactly upright, is brought into and directed to the center, with the bevil in the proper line for the surface. During its subsequent advance, the contact between the flat bevil of the tool, and the flat surface formed upon the work, constantly increases, and greatly aids in maintaining the chisel correctly upright.

As with the gouge, it is difficult to so exactly direct the chisel, as to produce a surface requiring no subsequent correction. The places in excess are detected first by the eye, and then as the surface becomes more nearly correct, with the straight edge; they are reduced by shavings varying in thickness, commencing with and dying away to nothing, taking effect upon the high parts only. The variation of the thickness of the shaving, is readily produced by moving the handle, to vary the horizontal position of the tool, which places the cutting bevil more or less out of coincidence with the surface; but the movement required is so slight, that although sensible to the touch it is hardly so to sight. The surface when true from correction, greatly assists the traverse of the chisel for the finishing cuts, which should consist of thin shavings, extending when possible, uninterruptedly from the circumference to the center of the work.

THE BACK SURFACE.

The surface may be turned at either end of a cylinder, when held between centers. That next the popit head is first finished, almost, but not quite, to the center; leaving a small central projection for the support of the point, which is treated as in turning a cone, standing the same way as the point of the popit head. The two are then carried on simultaneously, the surface being finished to the center and the little cone to its apex, which separates them one from the other. The point of the popit head is then advanced to make a fresh center in the finished surface, to afford support to the work while turning the surface at the chuck end. A small portion of the wood against the prong chuck is sacrificed, turned to a cone in the same manner and separated from the back surface, at the moment the latter is completed to its center, when the work falls free from the chuck. This method is constantly followed, either for surfaces or other forms, and presents no difficulty, except that the work may become disengaged from the cone which carries it at either end, before the surface is sufficiently finished.

When the work is mounted in a plain driving chuck, figs. 346, and 349, undivided attention can be devoted to the management of the tools, the work is secure, with or without the support of the popit head, and in the latter case, the front surface neither requires the supporting cone, nor shows the center mark left by the point of the popit head. The surface at the chuck end of the cylinder is turned with still greater ease and convenience, when the work permits of being reversed and re-chucked, in a plain wood chuck or in a spring chuck, when it occupies the previous position of the front surface.

The back surface when turned as such, is commenced by a division in the material fig. 346, which may be made by a series of cuts with the gouge, held on its side and turned over between every cut, as shown by the dotted lines. The surface end of the gap is made nearly perpendicular, the bevil of the tool being directed in agreement with that plane; the gouge is followed by the chisel, to finish the surface, and separate it from the portion next the chuck. The division may be made entirely with the chisel, fig. 349, when thus made, it is

narrower and wastes less wood, the tool does not require turning over, but only that its angular direction be changed, when withdrawn from the work between every cut. In other respects the tools are held and managed as upon the front surface, except that the work being now left-handed, the angular positions are reversed.

The back surface is finished with the chisel down to the bottom of the division, until found correct or flat as tested by the straight-edge, when it serves as a guide for the chisel while turning away the neck, to finish its center. The cutting bevil of the chisel, is then made to traverse the completed portion of the back surface without cutting, that is, in exact agreement, until the lower angle reaches the neck, into which it is made to enter a short distance, by pressure, with the coincidence of the bevil and the finished surface undisturbed. The edge of the chisel therefore, without touching the finished portion of the surface, takes it up exactly at its termination and prolongs it towards the axis, the depth it has entered the neck. The tool is withdrawn from this surface cut and presented again, just clear of the surface, the under side of its lower angle exactly radial, with the top edge of the blade a little inclined towards the chuck. In this second position the tool acts upon the neck alone, reducing the part touched by the tool to a cone, to the depth of the preceding surface cut. The chisel is next returned to the surface, which it prolongs a little further towards the center, followed by a second cut upon the cone, and a succession of these alternate cuts carefully taken, finishes the surface to the center and at the same time separates it from the piece in the chuck. When the work is of moderate size, the left hand is usually removed from the tool at the last cut and placed around the work, to catch it as it falls from the chuck.

When the cylinder is in excess of its required length, *the softwood parting tool*, figs. 333. 334, may be used to divide it from the piece remaining in the chuck. The parting tool is mounted in either a long or short handle according to its size, and is presented to the work the blade resting exactly vertically upon its edge, the grooved side beneath, with the apex directed radially. The two sharp points at the angle, formed

by the grooved side with the plain ground bevil, divide the fibres, cutting square across them like the point of a knife; the material removed is ploughed out by the angular groove between the points, which when keen leave the sides of the work fairly smooth.

As the parting tool approaches the center of the work, it is slightly retarded, greater care being taken to prevent the tool deviating from and falling below the radial line; should it do so, the tool pushes forward and becomes wedged beneath the small neck formed in cutting off the work, to the probable damage of its delicate points. When so misplaced it cannot regain its radial position by being forced upwards, for the rest acting as a fulcrum, the points would be forced into the neck and broken; to free the tool, the point is still further lowered, the tool withdrawn from the work without stopping the lathe, and the cut recommenced.

THE SURFACE THE PLANKWAY OF THE GRAIN.

The cylinder and surface of the proportions of fig. 349, are about midway in a group, of which one extreme is a ruler, long and of small diameter, requiring truth only as a cylinder, the surfaces or ends subsidiary; and the other, a disc or plate, the diameter large compared with its thickness, in which, the surface is all important and the cylindrical edge much less so. Cylinders from the proportion of the ruler, to that of fig. 349, are made from wood the endway of the grain, that is, the fibre running in the direction of their length; from those of about the latter proportion to the other extreme, it is often convenient to turn the cylinder plankways, that is, with the fibre at right angles to the axis. The plate, is necessarily always cut from plank, whence the term plankways, and neither it, nor the ruler, could support the opposite conditions.

In turning the surface in softwood plankways, the tee of the rest is always placed parallel with it, close to the work and well below the center. Sufficiently so, to permit the cutting edges of the different tools as their shafts traverse the rest, to travel in a line that is horizontal and at the same time radial, to the surface under formation.

The piece of plankwood is cut roughly square and the center of the surface having been found from the corners, a

circle is struck with the compasses as a guide for sawing them off, to reduce it to a rough octagon. A hole is then made in the center with a gimlet or lathe drill, and the plankwood is screwed on to the *screw worm* chuck, fig. 295, with the precautions already described for truth, and for permitting the screw, either partially or entirely to penetrate the wood, as may be desirable. The work being set in revolution, a circle is struck with a pencil upon the face, to determine the external diameter of the plate; or, if the surface be rough and unfinished, the line is very generally scored with the *two* points of the compasses opened to the diameter required, and held and shifted laterally upon the rest until the two points both score one and the same circle. The parting tool is then applied, well outside of this line and parallel with the mandrel axis, to cut off the rough corners. The division is usually effected by two or more cuts, placed side by side on the surface, and running one into the other, to widen it and allow the parting tool sufficient

Fig. 351.

Fig. 352.

Fig. 353.

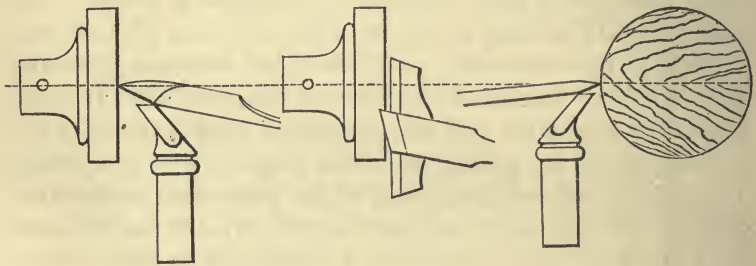

clearance; the width required, increasing also in some degree with the thickness of the plank. The corners come away all in one piece as a ring, at once giving the circular form to the edge of the work, and continuous action to the subsequent cut of the tool, when engaged upon the cylindrical edge.

In rough turning the plankways surface, the gouge is held after the same manner as on the cylinder fig. 335, lying on the center of its convex back, but with the shaft considerably less sloped, at about the inclination of fig. 351. The cutting bevil is very far from coincidence with the plane formed, and the tool is frequently mounted in a short handle, both to avoid

contact with the bearers and to give the blade a little additional slope, sometimes of advantage, in causing the tool to cut more freely. The surface is first reduced to truth by separate cuts, placed side by side, and then turned flat by traversing the tool, the right hand leaving the side, both hands moving with the gouge and maintaining its shaft always parallel with itself, during its traverse across the work. The fibrous surface left by the gouge, is turned smooth with the chisel, figs. 352. 353, which is held at a still less vertical inclination, with its side lying *flat* upon the tee. The chisel is traversed from the center, about two thirds of the distance towards the circumference; it may still lie upon the same side, but is usually turned over, to proceed from the circumference over the remaining distance, the separate cuts being made to overlap each other. The chisel requires to be keenly sharpened its edge straight and in good condition, and although its action is more nearly allied to scraping than cutting, it nevertheless removes a continuous shaving.

The entire width of the cutting edge appears to be in contact with the work, but in order to prevent the corners catching in and damaging the surface, the obtuse, nearly always the leading corner, is held just free of it, the shaving being cut by the remainder of the edge and the acute or following corner, which has the most penetration; exaggerated for illustration in fig. 352. In proceeding from the center as in the figure, the obtuse angle is free of the surface, and in travelling towards it, if the tool be not turned over, the acute is relieved; the following corner being again given the more penetration, by slightly varying the horizontal angle at which the shaft is held. The actual change required being so slight, as to be almost imperceptible except by its results. Neither angle of the chisel is permitted to pass beyond the center of the surface, the cut commencing or terminating at that point, always, by the extreme corner of the cutting edge. The flat tool obtains somewhat similar manipulation on the hardwood surface as noticed in the succeeding chapter.

The flat tool for softwood figs. 331. 332, may be used on the plankway surface in the same manner as the chisel. Occasionally also, its extreme corners are sharpened away on the oilstone in a gentle curve, so as to stand slightly behind the

general level of the cutting edge; the flat tool may then be traversed with its edge parallel with the surface. The chisel or flat tool, is held with hardly any vertical angle, or indeed quite horizontally for the finer finishing shavings, which are removed almost in the form of dust.

The plankways surface of a plate, when found to be true by the test of the straight-edge, serves as a guide for the parallelism of its cylindrical edge, which, from its large diameter and short length, is inconvenient to measure with callipers. The longer limb of a steel square is laid to the surface by its inner edge, and the shorter, excludes the light between its own edge and that of the cylinder, when the latter has been turned parallel. The position of the gouge and chisel and their manipulation upon the cylindrical edge of work turned plankways, fig. 353, is virtually the same as upon the surface. Concave curves are turned with the gouge, rounded edges and convex curves in mouldings, are first shaped with the gouge and then finished with the chisel. For this purpose, the latter tool is sometimes very conveniently applied to the work held in the horizontal manner as for hardwood, all the fingers of the left hand around the pedestal of the hand rest, with the thumb brought over on to the surface of the blade, pressing the tool firmly down, as it lies flat on the tee. The edge is then traversed around the work with a light cut, by the right hand at the end of the handle, swinging beneath the left thumb as on a center, the shaft of the chisel radial to the curve. Curves running from convex to concave, have the former portion finished with the chisel, and the line taken up and completed, as to the latter, with the gouge. Fig. 353, is also intended to indicate the manner in which the fibres of the plankways surface and cylinder as they meet the tool, perpetually vary from across, to with the grain; the reason for the wide differences in the positions of the tools, upon work the lengthway and the plankway of the grain.

CONES AND CONICAL SURFACES.

The two extremes of the cone merge respectively into the cylinder and surface; for cones approaching the one, the tool is employed in the manner described for the cylinder, and in that for the surface, for those approaching the other. The

group of cones fig. 354, makes it apparent that on the left, the chisel has hardly departed from its position for the cylinder, the tool lying on its side, the cutting edge an oblique tangent to the work ; while on the right, the tool rests on its edge, the cutting bevil in coincidence with the plane produced, as on a surface.

Upon cones between these extremes, the tool follows a path that partakes of and combines, the distinct movements required for the cylinder and surface. The motion of the tool is

Fig. 354.

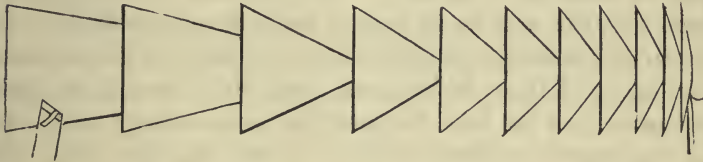

no longer simply lateral or radial, but as the tool travels laterally along the rest, it is simultaneously depressed from the circumference to the center, the cutting edge being always coincident with the plane of the surface of the cone under formation.

The gouge is first used to rough down the material to the requisite angle and measure, preferably under the guidance of a bevil, the correct angle so given materially assisting the subsequent guidance of the chisel. The chisel is supported on the rest on the under corner of its side the obtuse angle leading, the bevil lying on the cone, the opposite and following edge more and more raised, as the proportions of the cone become more obtuse, until for the most so the chisel rests exactly on its edge. The shaving is invariably cut with the tool travelling from the base towards the apex. The position of the rest may be parallel with the sides of cones midway in the group, for both gouge and chisel ; but for most, and especially for cones approaching the extremes, it is parallel with the axis of the lathe, as required by their analogy to the cylinder and surface.

In marking off the height of the cone, a sufficient margin is allowed for a small piece to be turned away to waste, used for the time, to receive the support of the popit head. This additional working length is first reduced together with the

general bulk of the cone, and then turned as a small reversed cone, both being finished at the same moment, after the manner described for separating the back surface of the cylinder. Double cones, starting from the same base, require this piece or reversed cone at each end.

SECTION IV.—THE INTERNAL CYLINDER. BORING. INTERNAL
SOFTWOOD TOOLS, HOLLOWING WITH THE GOUGE, HOOK
AND SIDE TOOLS. THE INTERNAL SURFACE.

The smaller examples of the softwood internal cylinder, are the apertures for the "plain fittings," by which one part of the work is attached to another. This method of attachment is both stronger and more readily made in softwood than the screw, and is usually employed when the latter is not essential. The lesser of these holes, from about one sixteenth, to about one quarter of an inch diameter, are conveniently made with the carpenter's ordinary shell or nose bit, figs. 452, 454, Vol. II., and the larger, up to about half an inch diameter with the spoon bit, fig. 453. Fittings larger than half an inch diameter, after being commenced with the bit, are enlarged by a small hook or side tool, used in the manner described for larger works.

The smaller bored apertures, are generally made of sufficient depth to be left from the pointed bit, as in fig. 355. The security of the joint, depending on the pin or counterpart being turned parallel, of a diameter to fit the aperture, and the external faces shown by the dotted lines, true surfaces; these latter then also fairly meet, and the joint shows no external gap or interval. In some cases it is more convenient and may give additional strength to the joint, to bore apertures in both the pieces, figs. 355, 356; these are then connected by the insertion of a separate parallel turned pin, which may thus be made from a tougher or harder wood.

A center for the first entry of the bit or tool, is struck in the work with the acute angle of the chisel. The rest is placed rather high, that the blade of the tool, lying nearly flat supported on one corner of its edge, may slope slightly downwards; the shaft of the tool being also at a small horizontal angle. The center produced, the small internal cone, fig. 357, is almost invariably used in all materials for the guidance of

all internal turning tools. Turned true or concentric, the center of the cone is identical with the axis of the mandrel, and directs central all pointed tools and drills, such as the spoon bit for softwood. The true sides of the cone arrest in their angle and bring to center all tools with blunt extremities, like the cylinder bit or nose bit; and the turning tool, when placed against the side of the cone, is also true. In striking

Fig. 355.

Fig. 356.

Fig. 357.

Fig. 358.

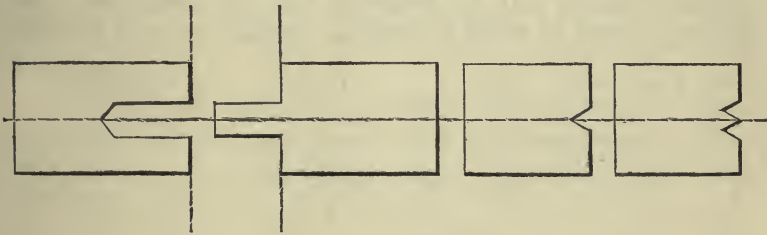

a true center it is however necessary, that the acute angle of the chisel, or the point of the tool used upon harder materials, should be directed exactly to the center of the work; which point is readily detected by the eye, at the moment of presenting the point of the tool when the work is in rapid revolution. Should the tool miss the exact center, it forms both an internal and external cone, fig. 358; the latter has to be turned away by the point of the chisel, directed to its apex, and obliterated in the internal cone, which thus becomes unnecessarily large.

The nose or spoon bit, used in a short handle having a rounded end, is pressed into the wood by the palm of the hand, the forefinger and thumb stretched out along the tool, the handle held by the remaining fingers. The bit is advanced in the line of the mandrel, its shaft and handle serving as a guide to show that it is not inclined sideways and neither above nor below the mandrel axis. More care is given to the direction at the commencement of the cut, when the smaller and more delicate bits from their tendency to bend, have their cutting extremities supported by the two first fingers and thumb of the left hand. As the small hole acquires depth, it becomes both a guide and support for the boring tool as that advances, whence it is the more necessary that its first com-

mencement should be made carefully true. The bits require to be frequently withdrawn from the holes to clear them from the shavings, which collect as a hard core in the hollow of the tools and interfere with their cut by setting up heat and friction; both of which may be reduced, by from time to time greasing the blade of the bit with tallow.

Internal cylinders or apertures of sufficient diameter, but of moderate depth, may be hollowed from the solid with the ordinary gouge, in which process the cutting action of the tool

Fig. 359. 360. 361.

Fig. 362.

Fig. 363.

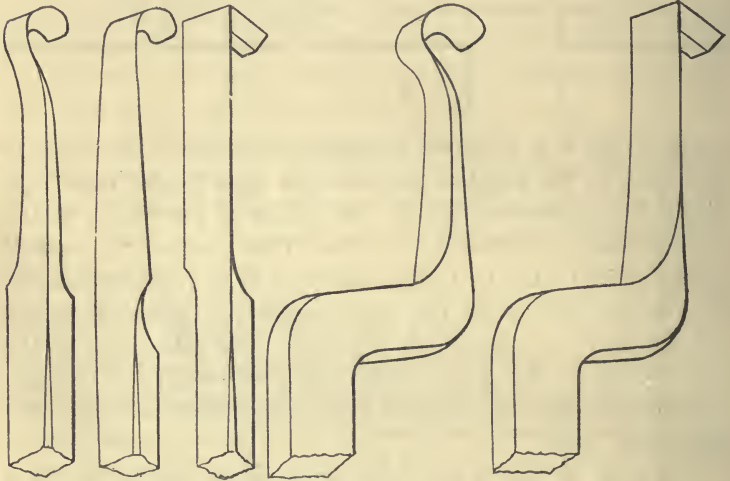

is precisely the same as upon external work. Deeper cylinders and other internal forms, are hollowed with the internal tools for softwood, figs. 359 to 363, those most generally in use; together with some others, shown on pages 514 to 516. Vol. II.

The cutting edges of the various hook tools or internal gouges, and those of the side tools and broads, or internal chisels, may all be viewed as those of simple gouges and chisels, and their different shaped stems and shanks, only as the means by which they are applied to the work and brought as nearly as circumstances will permit, into the theoretical

positions of coincidence with planes and of tangents to circles.

The outer sides of the cutting portions of all the five tools, figs. 359 to 363, represented with their cutting edges uppermost, are nearly upright or square to the face of their stems; they are ground and sharpened with one bevil, upon their inner sides only, the cutting edges being keen like that of the chisel. The *hook* tools, figs. 359 and 362, are sharpened to cut only around the hook portion, the terminal angles being usually rounded off; fig. 360, is sharpened around the hook and also along the entire straight edge, combining the hook and side tool.

The end and the long side cutting edges of the *side* tools, figs. 361 and 363, are ground after the same manner; they meet at rather *less* than a right angle, the internal angle being very keenly sharpened. The length of the side cutting portions varies from about one and a half to three inches. The stems of all the foregoing are strong, usually of rectangular section with the corners removed, some are round, and the internal tools are in most cases used in long handles; figs. 362 and 363, are perhaps somewhat more easily held and directed, the cranked formed stem affording increased surface contact on the rest.

HOLLOWING WITH THE GOUGE, HOOK AND SIDE TOOLS.

The long handled gouge used for hollowing, varies from three eighths to about threequarters of an inch in width, according to the size of the aperture to be made. The end of the work is first turned true and moderately flat, the gouge is then traversed from the circumference to the center, cutting upon the surface in the usual manner, lying on its side, the bevil in coincidence. Instead of being withdrawn when it arrives at the center, while still cutting, it is thrust further forward in the same line a little beyond it; and at the same time, is urged into the face of the work, by the cutting bevil being made to assume a greater angle than when surfacing. The increased inclination being effected by a slight pull upon the shaft of the tool with the left hand, accompanied by a slight sway of the body to the right.

The cutting edge thus thrown out of coincidence, buries

itself in the face of the work, whereupon, while still cutting it is raised by gradually depressing the handle, until the gouge arrives at the dotted position fig. 364. As the cutting edge travels upwards, the shaft of the gouge is also made to rotate a quarter turn upon itself, by slowly turning the right wrist; the two motions are simultaneous and terminate as the tool arrives at the end of its ascent, when its convex side is uppermost, and its cutting edge at a tangent to the internal circle. The path of the gouge in hollowing therefore, carries the bevil of the tool from the position of coincidence with the surface, to that of a rather oblique tangent to the internal circle, and is the effect of a quadruple motion; the tool is advanced considerably beyond the center, is raised in the curve of the

Fig. 364.

Fig. 365.

Fig. 366.

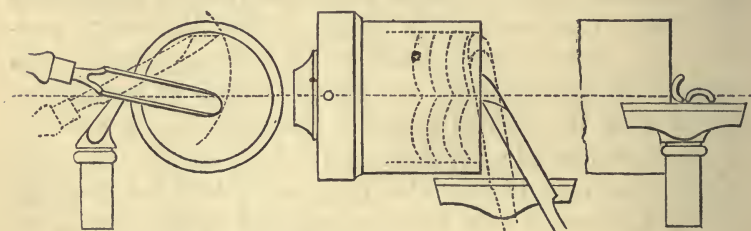

dotted line, is turned one quarter round, and travels laterally upon the rest, fig. 366, a distance equal to the depth hollowed in the work. The cut commenced on the surface, is carried on without cessation into the hollowing, when the whole of the cutting takes place with the edge of the tool pushed beyond the center and reversed; the lathe having continuously revolved towards the operator.

It is however by no means necessary that the tool should proceed along its entire path, to make the cut at one sweep, but it may be arrested and the cut recommenced, as often as may be found convenient. The gouge cuts with avidity and requires to be held with considerable firmness, and this is the more necessary as the aperture becomes deeper by every succeeding cut. The first, sinks a hollow or dishes the surface, leaving an opening rather high at the center, with a round corner at the circumference. The succession of cuts, fig. 365, leaving the work an irregular internal cylinder, the sides and

base of which are subsequently turned square. The reversed position of the tool beyond the center is unique and confined to the gouge, with which it is rapid, very efficient and not difficult to acquire. Hollowing with the gouge however, cannot usually be carried to a greater depth than that of about the radius of the aperture ; at increased depths the tool is difficult to direct, and is exchanged for the hook tool, fig. 359 or 362.

In hollowing the internal cylinder with the hook tool, the rest is placed above the center, sometimes parallel with the surface and at others rather obliquely to it. The left hand grasped around the shaft of the hook tool, and the right at the extremity of the handle, are both well above its cutting edge which overhangs the rest, fig. 368 ; when the tool is said to be held "underhand," in distinction to its overhand position, as on the cylinder fig. 335.

In holding the tool under hand, the left hand is grasped around its shaft, knuckles uppermost. The right hand may

Fig. 367.

Fig. 368.

Fig. 369.

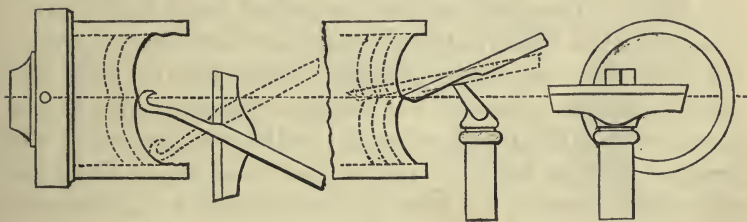

either grasp the handle as before, the thumb uppermost, the arm at right angles bent by the elbow, or, which is generally more convenient, with the knuckles uppermost, the wrist underneath the handle ; the whole arm close to the body almost in the same plane with the tool, and the right hand against the right side of the chest. The end of the handle is sometimes placed on the right shoulder, the hand is then shifted down the handle, so as to be midway between the shoulder and the rest ; this position is more required for metal than for wood turning. The height of the rest, fig. 368, places the stem of the hook or side tool, at about the vertical

angle required for the cutting edge to assume its correct cutting position. In the other direction, the hook is presented to the center of the work, with the stem at a horizontal angle fig. 367; and while cutting the tool is made to swing upon the rest as on a center, describing the curve indicated by the dotted lines, producing a very similar shape in the hollow, to that produced by the gouge. The hook tool sometimes also acquires a slight tilt upon the left under corner of its stem.

The cut is obtained principally by pressure, and sometimes but in a less degree, by slight leverage or lowering the handle to obtain a trifling alteration in the vertical angle. In turning large work the weight of the body is moderately thrown upon the tool, which then obtains the cut without great muscular exertion. A succession of cuts from the center to the circumference is continued to the required depth, but as this increases, in order to avoid the internal edge of the cylinder, the vertical angle of the shaft necessarily becomes less; sometimes, the rest has to be lowered and the tool held more nearly horizontal, which is much less favourable to its action. The sides of the internal cylinder, left irregular by the gouge or hook tool, may be turned fairly smooth and parallel with the latter. The tool is now supported quite horizontally, grasped by the hands in the manner described for the gouge, fig. 335, the rest being lowered sufficiently to place the cutting edge at, or near to the height of center. The tool is traversed to and fro, with its shaft parallel with the line of the mandrel, slightly tilted on its left under corner, to place the edge in the position for cutting; the shaving being obtained by simple pressure or by slightly twisting the handle to reduce the angle or tilt. The cylinder is frequently tested with the callipers to ensure that it is not turned taper in either direction, and is finished by a series of light cuts taken from the bottom outwards, which leave the sides in fair condition for smoothness, but of necessity with a round corner at the junction of the cylinder with the surface. The rough internal surface, is more or less concave and in rings, but for many purposes this also may be sufficiently corrected with the hook tool.

The side tools figs. 361. 363, are used after the hook tool,

for turning more exact internal cylinders and surfaces, figs. 370. to 372. ; they are held and used in much the same manner as the hook tool, just described, slightly tilted on the left under corner of the shaft. The long straight cutting edge of the side tool, would take too great a hold upon the work if permitted to cut by its entire length. The shaft of the tool therefore, is first held parallel with the cylinder, and then by an almost imperceptible inclination given in the pressure, the cut is made to fall principally on a portion of the edge, nearest the end or corner formed by the side and cutting edges. This very slight horizontal inclination gives the extreme end of the side edge the most penetration, causing the cut to gradually cease a short way up the edge ; while, as the shaving is removed from the bottom outwards, the action of the side tool nearly approaches that of attacking and removing the fibres endways, the advantages of which have been previously explained. The side tool, fig. 374. Vol. II. is used in a similar manner for large works.

The thickness of shaving that the hook and side tools are intended to cut cannot easily be definitely stated, it varies

Fig. 370.

Fig. 371.

Fig. 372.

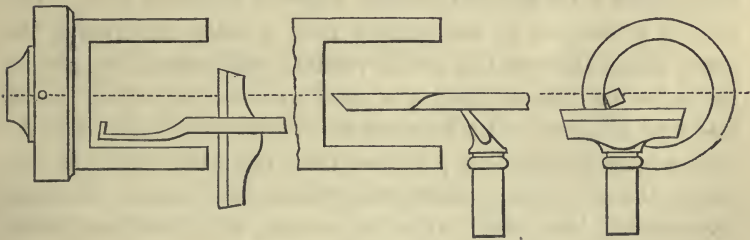

both with the variety of the material, and with its condition as to dryness ; the tools cut very freely in the softer woods, pear to pine, but much less so in beech and mahogany. The variable quantity is pointed out by the behaviour of the tool itself, and is also felt by the strain thrown upon the hands and arms when the tool is too much urged. The tool then rends off and does not cut the material, which results in the surface of the work acquiring a ragged, fibrous condition, and if this be allowed to continue, deep splintered cavities. A

smooth surface can only be restored by a series of light cuts carefully taken, sometimes difficult, as the roughened surface once established, jars on the tool and has a tendency to increase rather than diminish. The best result is more rapidly attained, by so increasing the number of separate cuts, that the amount removed by each may be well within the full capacity of the tool and material.

The internal cylinder the lengthways of the grain, roughed out with the gouge or hook tool, may also be finished smooth and true with the chisel, which tool also, is always used to finish that turned plankways. The chisel is presented lying flat and horizontally on the rest, which is placed across the mouth of the aperture, and the tool is thrust straight forward towards the bottom of the cylinder, cutting only by the extreme acute corner. The guide afforded by the straight edge of the side tool being absent, the truth of the line followed depends entirely upon the dexterity of the operator; moderate recesses, present no difficulty, but in deep cylinders, some little practice is required to produce an equal diameter from end to end; the tool is always held with firmness, and but a small amount is removed by every cut.

The internal surface at the base of the cylinder, fig. 370, is turned flat with the end cutting edge of the side tool. The tool is presented to the surface held a little underhand, the stem being allowed but small vertical inclination; it may lie quite flat on the rest, but it is sometimes slightly tilted on its left under corner. In turning the surface, the side tool requires considerably less pressure than the hook tool; it may also be made to cut by depressing the handle, placing the stem more nearly horizontal, when the cutting edge becomes nearly in coincidence with the plane of the work.

The internal surface is commenced from the center, by separate cuts each the width of the tool, which is shifted between every cut to place them side by side, just merging one into the other; the last cut reaches the circumference and obliterates the round corner left by the gouge or the hook tool. The irregularities and the round corner of the surface having been reduced into tolerable agreement under the guidance of a steel square, the marks left upon it by the separate cuts are removed in the finishing; effected by light continuous shavings,

principally taken from the center outwards, but sometimes in the opposite direction. As the end cutting edge of the side tool is traversed in either direction, the following corner, is made to penetrate the surface slightly more than the rest of the edge that *precedes* it; the other or leading corner, being held just free of the work, analogous to the action of the side cutting edge of the tool upon the cylinder. In these finishing cuts and in those on the internal cylinder, the tool is held lightly, so that the hands may feel whether it always retains the same amount of cut or hold upon the work from the commencement to the end of each traverse; but at the same time, the tool is held with sufficient firmness to maintain the cutting edge in the same angular position throughout. The sharp corner formed by the end and side cutting edges of the side tool being less than a right angle, when the end is cutting on the surface, the corner may be carried quite to the circumference, without the cutting side touching the internal cylinder. In like manner, the side edge may cut to the extreme end of the internal cylinder, without the cutting end of the tool taking any effect upon the surface. Both surface and cylinder may thus be separately worked upon without damage to either, and their corner finished accurately square to the right angle, joining the true internal surface and cylinder.

The internal surface fig. 370, is perhaps one of the most difficult from the depth and proportions of its accompanying cylinder, which cause the edge of the tool to be at some distance from the point of support; with decreasing depth, the application of the end of the side tool is proportionately easier. Internal surfaces at slight depths are conveniently turned with the broad fig. 372. Vol. II., held underhand, the stem at a vertical angle of from 40° to 50° . The cutting edge of this tool is ground to slope equally both ways, like a gable, it can therefore be traversed either to or from the center of the work, with the back lying flat on the rest and does not require tilting. The stem of the tool is also presented at a small yet sufficient horizontal angle, to cause the leading corner of that side of the cutting edge that is at work, to travel just free of the surface. This tool is also made with straight and round cutting edges, the former for corners, and

the latter for rough facing the surface, used instead of the gouge.

The internal cone when turned in softwood, is nearly always truncated; it is first hollowed out with the gouge or hook tool under the guidance of the bevil, the sides are then turned smooth with the side tool, and the surface, with that or the broad, as may be more convenient. The application of the tools is virtually the same as to the internal cylinder and surface.

SECTION V.—THE SPHERE AND INTERNAL HEMISPHERE.

The sphere in softwood is little required for other than ornamental purposes, and for these it can readily be turned with the gouge and chisel; while the material is hardly suitable for spheres of greater accuracy, such as may be made in hardwood or ivory, by the method described in later pages. This figure has been considered last in the series of elementary planes and solids, because facility of hand acquired on the cylinder, surface and cone, is necessary to correct and easy guidance of the chisel on the sphere; the path of the tool being a combination of the motions separately used for all three.

The sphere has been variously defined, but the path necessarily followed by the chisel in its production may perhaps be allowed to give a practical or turner's definition, viz., that the contour of the sphere is formed by a series of minute portions of cones, extending each way equally from its circumference or diameter to its axis; the examination of which definition may afford some assistance in the manipulation of the tool, during the successive stages of the development of the softwood sphere from the cylinder.

In the sphere fig. 373, revolving upon a. b. the axis of the lathe mandrel, it will be seen that there is one plane c. d., where the chisel can only cut when it lies on its face, as in turning the cylinder; this place in the traverse of the tool may therefore be considered as a minute portion of a cylinder. There is another plane a. b., where at the point b., the chisel can only cut when supported on its edge, as in turning the surface, this is therefore as a minute portion of a surface. In traversing the successive portions of the curve d. b. the cutting

position of the edge of the chisel is gradually transferred from that for the cylinder at d., to that for the surface at b. During which progress the edge passes through a series of positions, in every respect equivalent to those required for a series of cones, each of minute length; while from the continuous motion of the tool these minute portions of cones are continuously produced and glide one into the other, forming the curve. The chisel travels round the sphere by a triple impulse or change; it slides laterally along the rest, the distance from

Fig. 373.

Fig. 374.

Fig. 375.

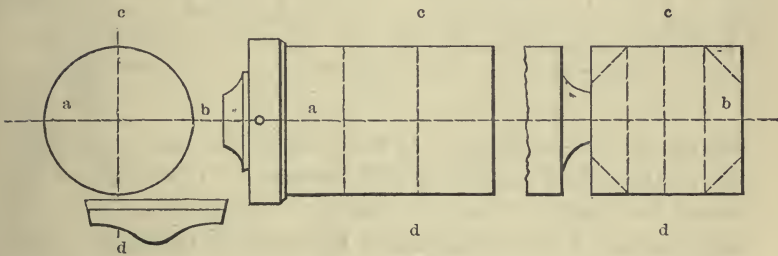

d. to b.; it rotates one quarter turn, in the course of its traverse between these two points, for the blade which lies flat at d., is on its edge at b.; and thirdly, the cutting edge is continuously depressed from d., when it cuts by a portion of the edge as on a cylinder, until it arrives at b., where the cut is terminated at the center by the extreme point or angle, as on the surface. The rest stands parallel with the axis of the mandrel, necessary to the commencement, progress, and termination of the cut; and the tool having traversed the curve d. b. is turned over to proceed from d. to a.

The chisel travels in either direction around the curve, with the obtuse angle leading, but it is absolutely essential to successful cutting on the soft wood sphere, that its straight cutting edge be always maintained fairly parallel with the mandrel axis a. b. The stem of the chisel, stands therefore nearly at right angles to a. b.; while should it at any time wander from this position, so as to acquire more horizontal angle, the cutting edge ceasing to be parallel to a. b., immediately catches in and damages the surface of the sphere.

Small spheres not requiring particular accuracy, may be

turned at once by the gouge and chisel; first taking the precaution to turn the cylinder true, and to mark off upon it as a guide, its diameter, and the central line c. d., fig. 374, the base of the two hemispheres. As the sphere then depends

Fig. 376.

Fig. 377.

Fig. 378.

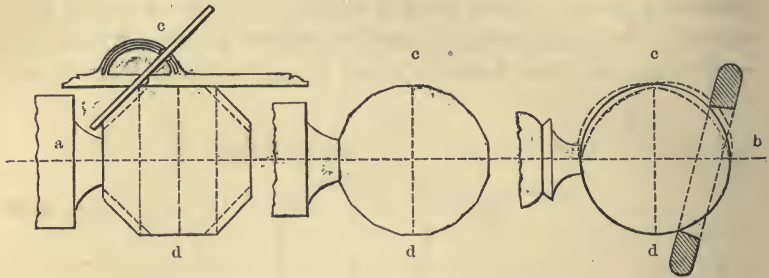

entirely on the path given to the tools, their use, especially that of the chisel, requires a little practice. If the chisel be twisted too rapidly, it will produce two rounded cones base to base, instead of two hemispheres, as shown by the dotted lines fig. 378; but if not sufficiently so, it will leave the material in excess, the lesser evil, as admitting correction.

A guide for the path of the tool for larger or more perfect spheres, may be obtained by the polygonal system, figs. 374 to 378. The material is first turned to a true cylinder, a little larger than the diameter of the intended sphere, and the end surface turned true. The exact diameter is then taken with a pair of callipers, and marked off upon the cylinder, measured exactly from the end or surface fig. 374; a line to mark it being slightly cut into the cylinder by the edge of the chisel, presented vertically. The diameter thus marked as the length of the cylinder is then divided by a pair of spring dividers, and a second or center line c. d., the base on which the two hemispheres are to be turned, is marked in the same manner. The portion of the cylinder next the chuck beyond the first line, is then reduced somewhat to the shape required to fix the sphere to further portions of the work; the back surface is turned true, without encroaching upon the length of the block left for the sphere, and the distances a.—c. and c.—b., bisected and marked with the lines, fig. 375.

The corners formed by the cylinder and its surfaces, which

seen in section are right angles, are turned away so far as the lines last marked, to an exact angle of 45° , indicated by the dotted lines fig. 375, under the guidance of a bevil, applied on the cylinder or surface. When, provided that in the first instance, the length of the block exactly equalled its diameter, the length of the cylindrical portion and the diameter of the surface remaining, will be equal. These two bevils or cones turned upon the cylinder are then still further reduced with the chisel, and still strictly maintained at the angle of 45° . As they are turned, they become wider and gradually encroach upon the portions of the cylinder and surface; until as tested by measurement, the cylindrical portion, the cones, and the diameter of the surface, are all of equal width or length, fig. 376. Carrying this a step further with the same means, the eight angles of 135° thus formed, are reduced or divided to sixteen planes, and angles of $157\frac{1}{2}^\circ$, fig. 377, and if the sphere be large enough to require it, then to thirty-two; thus actually in practice continually reducing the cylinder to the series of short cones, which were said theoretically to compose the path of the tool. The series of rings or facets reduces the block almost to the circular line, and forms an efficient guide for the traverse of the tool, around the contour of the sphere. The final process, is to make the chisel traverse this path from d. to b. and from d. to a., its stem *always* at about right angles to the axis a.—b., aiming to remove an equal thickness of shaving throughout, and cutting no more than is sufficient to obliterate the angles and surfaces of the short pieces of cones to melt them into one circular line. When the sphere has to be separated from the neck, the principal work is done and the sphere completed up to the neck while that is still strong; the small portion remaining, is then finished simultaneously with the reduction of the neck to separation, as already described for the back surface.

Too much material left, or too deep a cut of the chisel at any portion of the spherical line, shows either as a swell, or as a flat or groove around the sphere. These errors have to be corrected by further traverses of the tool, either to remove a partial excess, or to reduce the whole sphere uniformly, to the depth to which the tool at any part may have accidentally entered upon it. A ring turned perfectly true, with its internal

diameter somewhat less than that of the sphere, is employed as a gage to detect such errors. It is applied at different angles all over the sphere, fig. 378, which when true, exactly fills or agrees with the true circle of the ring; any excess or depressions are readily appreciated, and their situation marked with a pencil for subsequent correction.

INTERNAL HEMISPHERE.

The internal hemisphere of large or small diameter figs. 379. 380, is roughly hollowed to shape with the gouge, used as described for the internal cylinder; it may then be entirely completed with the gouge held and used as on the plankways surface, or, sometimes more conveniently with the hook tool. The hook tool is held well underhand, and is swept around the curve with a moderate cut but free action, so far as the two positions fig. 379, usually commencing to cut from the center. The tool is moved by the action of the body and hands, both

Fig. 379.

Fig. 380.

Fig. 381.

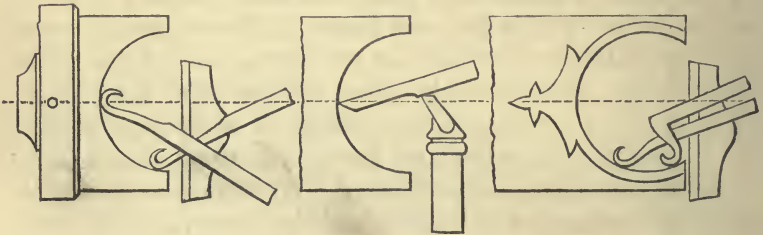

always exerted upon it, but in varying degree. Towards the center, it is held firmly to the side and is moved more by the sway of the body; as it travels away from the center towards the circumference, it is controlled more by the pull of the left hand, the right hand and the handle of the tool frequently having to leave the side. The orifice or lip of the curve, may also be turned with the stem of the hook tool nearly parallel with the axis of the work, the tool is then again held against the side, and is withdrawn cutting outwards by the backward poise of the body.

The cutting action and management of the hook tool in the internal hemisphere, combines those necessary to this tool on

the internal cylinder and surface ; while, for about two thirds of its traverse around the curve, *from* the center, the hook tool divides the fibres across the grain, and for the remaining distance, removes them with the grain. It leaves the work clean and sharply cut and does not require to be followed by any other.

A thin ring or plate, accurately turned to the required diameter, fig. 437, may be applied from time to time within the internal hemisphere or cup, as a gage, to test the truth of the sweep and equal cutting action of the tool around the curve. The portions in excess of the true line prevent its entry, these, are noted and reduced until the two are in agreement ; when the last thin and equal shavings, are taken continuously from one end of the curve to the other, from the center outwards. The orifice of curves greater than the internal hemisphere, such as fig. 381, the hollow form employed for humming tops, more or less impedes the traverse of the straight stemmed hook tool. Internal forms of this character are worked with it, so far as they will permit, and a hook tool, differing only in its having the stem bent at right angles, is then employed to turn the end of the curve towards the opening.

CHAPTER VIII.

THE ELEMENTARY PRACTICE OF HARDWOOD AND
IVORY TURNING.SECTION I.—HARDWOOD AND IVORY TURNING TOOLS, POSITION
AND CUTTING ACTION.

THE turning tools used for both hardwood and ivory are almost invariably held radially, with their shafts nearly horizontally. They act more as scraping than as cutting tools, and are therefore no longer so nearly restricted to a rectilinear cutting edge, but, they may be shaped straight, hollow, or round; the figures of their edges being directly imparted to, or modified upon the work as required. The tool when cutting in either material, lies always in one plane upon the rest, either held stationary, when applied to the work to copy itself, or else traversed along a cylinder or surface, or swept around a curve, to produce these forms; the manipulation being simple and requiring none of the angular changes of position necessary upon softwood.

The hardwoods may be turned with the softwood tools, used as upon softwood, but the delicate edges of most of the tools are so soon blunted or damaged, that they are not generally so employed. The gouge and chisel are exceptions; the gouge is generally used for roughing out the form in hardwood and ivory, held in exactly the same angular positions and sometimes after precisely the same manner, as in turning softwood. The chisel is less used, and is sometimes held quite differently, but both tools, in common with other softwood tools when used, are ground to the less acute angle of 50° to 80° , to preserve their edges from too rapid deterioration.

The forms of the hardwood and ivory turning tools most in use, figs. 382 to 407, reproduced from Vol. II. for convenient reference, divide into two groups, having rectilinear and curved cutting-edges respectively. The former are used for surface and cylindrical works, spheres and convex forms; the latter, some to turn their own counterparts, figs. 395 to 401, others for this, and for producing concave curves larger than themselves. The

tools are represented with their faces uppermost, the cutting bevil being indicated by the dotted lines.

As scraping tools, the hardwood and especially the ivory tools, are thin in proportion to their width; they vary with the size of the tool, from about one eighth to one quarter of an inch, some large tools occasionally reaching three eighths of an inch in thickness. All, are ground with a single bevil, or on the one face only, with a cutting angle of from 40° to 60° , and are handled principally in short handles, with which they measure from about eight to twelve inches long. Some of the larger of the tools, figs. 382 to 395 are required in long handles.

The *right side* tool fig. 382, so named from its cutting on the right hand end of the work, from the right towards the left, is used for surfaces and within cylinders; it is sharpened on the side and end, the cutting edges meeting at less than a right angle. The side edge varies from about one and a

Fig 382. 383. 384. 385. 386. 387. 388. 389. 390. 391.

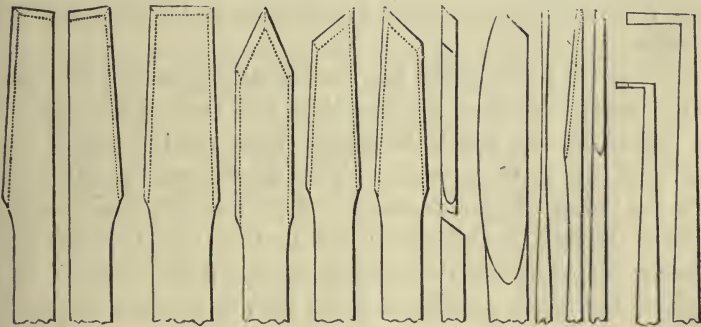

half to three inches in length. The right side tool is also required in smaller sizes fig. 390, the side edge from one to one and a half inches long; these tools being very narrow in the blade to enter small apertures, are made of a greater proportionate thickness to give them stability. The *left side* tool fig. 383, is the reverse, cutting from left to right, and is principally used for external work.

The *flat* tool fig. 384, varies from about one inch and a quarter the largest, to a very narrow width in the smallest sizes, it is ground on both edges and the end. The end

cutting edge is sometimes exactly square with the side which cuts from the right ; more usually, it is ground at slightly less than a right angle to this side, as in fig. 419, when the flat tool, like the side tools, applies in rectangular corners with either the side or end edge of the tool, alone cutting the work.

The *point* tool fig. 385, is ground with equal angles ; the *bevil* tools, figs. 386. 387, with one angle only, all three tools are also sharpened along the sides of their stems, which is convenient, although the end is more used. Other varieties of point tools are formed with dissimilar angles, or by one straight and one curved side, to be used for grooves of particular shapes requiring repetition, as in chessmen and similar objects. *Thick point* tools, seen edgewise, fig. 388, from half to three quarters of an inch wide, and three eighths to half an inch thick, the sides of the stems not sharpened, are used both as ordinary point tools of greater strength, and also for turning beads and mouldings. For the latter purpose, they may cut with the edge formed by the meeting of the two bevils, when the tool resembles a very thick chisel of inconsiderable width ; its management being very similar to that of the chisel on softwood.

The *parting* tool fig. 389 has considerably greater depth than width, the smaller sizes are very thin, and the cutting edge of the larger, at the point the widest part, rarely exceeds one eighth of an inch in width. The sides taper in thickness from the point, to give clearance and prevent the tool binding or sticking fast in the work ; the parting tool in cutting is directed radially from the circumference to the center. The blade of the *inside parting* tool, fig. 391, is at right angles to its stem, it varies from about one sixteenth, to one eighth of an inch in width, and from a quarter, to about an inch in length. The two sides of the blade are ground away taper, to leave the end the cutting edge, the widest part, and nearly meet beneath the face in an angular section, to allow freedom for the cut, and to prevent the tool setting fast in the work.

The *round* tool fig. 392, the most useful of the curvilinear edged tools, varies from about one sixteenth, to about one and a half inches in width, the gradations in size below half an

inch being very numerous. The smaller tools are used to turn ornaments and mouldings, the larger, for mouldings and all concaves. Small strong round tools also take the place of the gouge, more especially in ivory turning, in roughing out those parts of the work for which the latter is too large.

The *quarter round* tools, right, fig. 393, and left, fig. 394, are used of all sizes from about one eighth, to one inch wide; they serve to turn their exact counterparts in mouldings, for larger curves, and for those that abut against a square shoulder. The *quarter hollow* tools, right, fig. 397, and left, fig. 398, produce their counterparts; they are usually rather less in range of size than the quarter rounds. These three varieties, are named from the forms of the tools, and not from the shapes they produce on the work.

The *bead* tool, fig. 395, is used for beads as members of mouldings, and for the small spheres for bracelets, necklaces and ornament. It ranges from about one sixteenth, to one

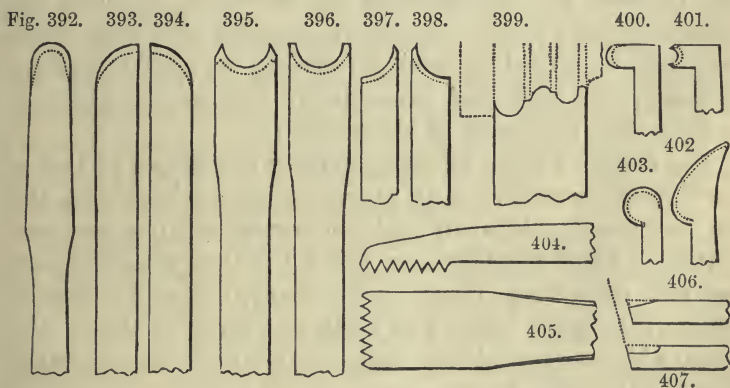

inch in width, the sizes varying very slightly in the smaller tools; the curve is rather less than the half circle. The ornament of the bead, may be turned with the point and other tools, first the one side of the curve and then the other, precisely alike, but this is sometimes difficult to accomplish especially if the bead be small; there is also the liability of damage to the bead or the neighbouring surface, from faulty management of the point tool. The form can be readily and more correctly given to the tool, when its counterpart and duplicate beads can be turned with uniformity.

The larger bead tools on the other hand, are not directly applied to the work, as the points would sustain too much friction, their entry being retarded by the quantity of material lying between them. They, and the work, would heat; besides which, from the length of the cutting edge, the tools would *chatter*, the vibrations, together with the friction producing a roughened surface. The semi-circular edge of a three quarter inch bead tool, for example, would be nearly one and a quarter inches long if a straight line, which is a greater length of cutting edge than can be effectively employed with any rectilinear tool. Bead tools more than about half an inch in width, are used first as gages, to which the work is roughly turned with the point and other tools, afterwards, when they have but little material to remove, the bead tool is used to finish the surface, correcting the rough form to its own shape.

The *astragal* fig. 396, produces a bead and fillets, free from the chamfers of the plain bead tool. They are employed in sets of small and varying sizes for mouldings, in which the astragal forms a frequent member. Isolated and large astragals may be turned by leaving sufficient material to use the ordinary bead tool, and subsequently forming the fillets by turning away the excess on either side.

The *moulding* tools, fig. 399, combine the shapes of two or more of the preceding with others in one cutting edge, and are very serviceable when made to correct architectural proportions. Small mouldings are difficult to turn with exactness, and still more so to repeat in fac-simile, except by forming their profile in the tool. The width and depth of the moulding to which these tools are quite suitable however, are rather limited; the width hardly exceeding half an inch. Thus, the curved edge of fig. 399, as a straight line, would be nearly double the width of the tool; parts of the edge also cut across the grain and others with the grain, while the tool necessarily cuts at different surface velocities, according to the depth of the moulding. All these circumstances combine to produce a roughened surface upon some of its members, should the moulding be either too deep or too wide. The size of the completed moulding may be increased, if the tool be confined to the figure of its central portion, adding the fillet, plinth or cavetto, by separate appropriate tools, as shown by the dotted

lines ; or, the moulding may be made in two or three separate tools. The roughness, arising from the friction and heat set up by the more prominent parts of the tool, may also be avoided if the tool be first used as a gage, to which the material is first roughly turned with separate tools, as explained with the bead tool. Larger mouldings are turned each member separately, with the curved tools, figs. 392 to 398, the flat and point tools being used for the fillets and quirks, connecting them one to the other.

POSITION AND CUTTING ACTION.

All the hardwood and ivory turning tools handled in short handles, are presented to the work radially and about horizontally, fig. 408, their under surface lying either nearly, or else quite flat upon the rest. To place the face of the tool both precisely radial and horizontal, the rest would necessarily require raising or lowering to accommodate the thickness of every individual tool. Practically, this is not done ; the rest is adjusted to a suitable height for a tool of average thickness, when that for the moment in use, fig. 408, sufficiently approaches the cutting position, if the handle be held slightly more or less above the horizontal line. For convenience of explanation however, the hardwood and ivory tools, may be said to be held in the *horizontal* position.

The handle of the tool is grasped in the right hand, with the forefinger and thumb stretched out along the blade, the under side of the thumb pressed on the face, and the inner side of the forefinger against the right side of the tool. The whole of the fingers of the left hand are passed around the pedestal of the rest, and the left thumb, pointing upwards, is pressed against the left side of the tool, opposite the end of the forefinger upon its right. The tool is thus held cushioned between the thumb and forefinger, pressed on the rest by the right thumb ; its lateral traverse in either direction being under perfect control by the pressure of the thumb or finger on the one side, and their gradual yielding on the other. The gouge and chisel are often held as upon softwood, but usually upon hardwood, and almost invariably upon ivory, they are used in the horizontal manner ; that is to say, the hands hold the tools and the rest in the manner just described, but they

present the tools to the work with their shafts at the vertical inclination, necessary as already explained, to cause their cutting bevils to lie as tangents to the cylinder.

During the deep separate cuts, used to reduce the work to shape, or in surfacing, with any of the hardwood tools figured in this chapter, and held in the horizontal manner, the upper arms are kept in close contact with the body, all braced stiffly together with the tool. The latter is firmly pressed on the rest, and is advanced to penetrate the work by the weight of the body moderately brought to bear upon it, or by lowering the handle to exert its leverage upon the edge. In cutting the subsequent lighter continuous shavings, the tool is traversed along the rest by gently swaying the body in the direction travelled; the arms still in contact, but all the body held much less stiffly, a little independent motion being allowed to the wrists and elbows to aid the equal traverse of the tool. For lighter and for precise cutting, and in sweeping the tool around small curves, the right arm may be held free of the body, and the left upper arm only in light contact. The tool may then be moved by the right wrist alone, and works upon the left thumb as on a center, or slides upon it as a stop, or sometimes, the left thumb pressed against the tool advances with it.

A few of the larger flat tools, parting, point, round and right side tools, used for heavy, and for large or deep internal work, require the additional command of the long handle. They are held with the left hand wrapped around the blade, the fingers underneath, the right hand towards the end of the handle, sufficiently high up against the side to cause the shaft of the tool to lie nearly horizontally upon the rest. The larger sizes of the short handled tools are sometimes held after the same manner; the right hand at the end of the handle, is then placed against the right chest, the arm pressed against the side. The size of the tool and its handle and the manner in which it is held, are greatly determined by the magnitude of the work. Large and strong tools are used to rough out the work nearly to shape, leaving but little material to be removed by the lesser and thinner tools, then suitably employed to perfect and finish the surfaces. Too slight a tool used for heavy cutting is inefficient and acquires vibration, it is then

difficult to produce a smooth surface; but the use of the slighter, narrow tool, required for small work, is sometimes unavoidable for those portions of large works that will not admit the width of the larger tools.

The tools cutting upon their ends, fig. 408, being generally presented to the work with their shafts at a small vertical angle, cutting action may be obtained both by simple pressure, or by lowering the handle, with the latter, leverage alone causes the edge to penetrate. The latter force however, may be readily applied in excess, to the damage of the work. The rest is placed so much closer to the work in hardwood turning, that comparatively a much less portion of the tool overhangs it, so that the leverage of the short handled tools for hardwood, is frequently still greater than that of the long handled soft-wood tools, previously referred to.

The side cutting tools are usually held slightly tilted upon their left under corner, their faces therefore being at a small vertical angle to the surface upon which they are cutting; leverage is obtained by slightly twisting the shaft upon itself, from left to right. The penetration then depends upon the amount of vertical angle of the face, when the cutting edge is placed in contact with the work, together with the amount of twist given to the shaft; which produces precisely the same effect, as the inclination of the shaft and the subsequent lowering of the handle, of the tools cutting by their ends.

The cutting action may be said to be nearly always obtained by some amount of pressure; but leverage so greatly assists direction, that alteration in the vertical angle of the shaft, either at the commencement or during the progress of the cut, is rarely altogether absent. In the heavier roughing cuts leverage preponderates, sometimes it is alone used; while in the last finishing cuts, the tool as a scraper receives only gentle pressure. The proportion in which the two forces combine, running almost in a regular progression, of more pressure and less leverage, as the work advances from the rough to the finished stages. The application of the hardwood and ivory tools is so similar, that with the mention of some peculiarities, the descriptions given in the following pages, will serve equally well for either material.

SECTION II.—THE CYLINDER AND SURFACE. THE ARMREST.
THE CYLINDER.

The hardwood cylinder, figs. 408 to 410, mounted between centers or in a plain chuck, as previously described, is roughed and then turned true with the gouge, which may have either a long or short handle. A series of separate cuts, commenced at the end and led onè into the other for the entire length of the work, and repeated if that be much out of truth, reduces its irregularities leaving it concentric and in ridges. The gouge lies on its side, and may be held and used exactly as on the softwood cylinder.

The ridges left by the separate cuts may then be reduced and connected into one line, by traversing the gouge along the rest, lying on its back, the hands and tool still in the position for softwood. The hardness of the material however, rather interferes with the equal traverse of the tool, which is liable to jerk from one ridge to the next or completely over it. The traverse is easier and more regular, when both hands are shifted to the blade, to hold it after the horizontal manner, with the left hand around the pedestal of the rest, keeping the shaft of the tool still in the sloping or overhand position required by the gouge, as in fig. 335. The center of the edge is then applied to reduce each ridge seriatim, and subsequently the gouge still held in the same manner, is traversed from end to end, until the work has acquired a moderate parallelism.

The hardwood cylinder is turned smooth and parallel with the flat tool, held in the horizontal manner, its under surface at first lying flat on the rest, with the shaft at about the angle fig. 408. The tool is retained at one spot until it has turned a portion equal to its own width, being made to cut by simple pressure or by lowering the handle. It is then withdrawn and shifted along the rest rather less than its own width, this second cut merging into the first; a similar third cut is then made, and so on for the length of the cylinder. The series of separate cuts leaves the work nearly the finished diameter, as tested by the callipers, but with numerous rings or lines upon it, breaks of surface continuity caused by the corners of the tool at every replacement.

Short cylinders, such as the plain fitting for the lip of a box, that are less than the width of the tool have no such marks, as the tool requires no lateral displacement, but marks from the separate cuts are not easily avoided upon greater lengths; they are obliterated by the subsequent traverse of the tool in finishing the cylinder to size and parallelism. The perfectly straight edge of the flat or other rectilinear edged tool, cannot practically be traversed, entirely in contact with the cylinder when lying flat upon the rest, without the corners catching or leaving fresh marks. The tool still held in the same manner, is therefore very slightly tilted upon its leading under corner, during its entire traverse, fig. 410; when it cuts by the middle of the edge, with the corners free of the work. When traveling from right to left, the tool is tilted on the left corner, its left side embedded in the left thumb, which, itself pressed on the rest, yet allows the corner of the tool also to touch it;

Fig. 408.

Fig. 409.

Fig. 410.

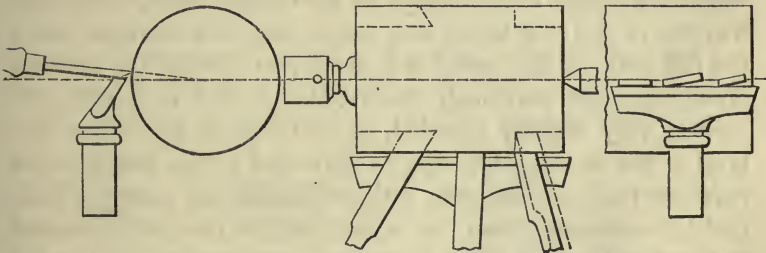

the following side of the tool is raised just off the rest, but is embedded in the forefinger which is pressed upon the rest. A uniform vertical angle is maintained during each entire traverse of the tool, and although the latter touches the support by only one corner, it is held even more securely, from being cushioned between the thumb and finger, and is less subject to vibration, than when, under similar guidance, it lies flat on the rest. The inclination and positions are reversed, when the tool is traversed from left to right.

Very little inclination suffices to free the corners, and no more is given; for, as the face of the tool departs from the horizontal line, so far the guidance of its rectilinear edge is diminished, and the tool, analogous to the chisel, becomes an

oblique tangent to the circle. Hardwood also does not permit nearly the same free traverse of the tool, as with the chisel on softwood, so that if the flat tool be too far tilted, the resistance of the material interferes and tends to reduce and vary the inclination; the effect of which is to turn the work into a succession of slight hollows instead of a straight line. On the other hand, increasing the inclination is an advantage in correcting errors, for which purpose the tool is tilted more or less, so as to take effect only upon the high portions of the line, the traverse of the tool being interrupted and recommenced as desirable during the corrections. As the cylinder approaches truth, its straight line materially assists both the traverse of the tool and the maintenance of its uniform angle, during the fine continuous shavings taken in finishing the work.

The flat tool may also be traversed without leaving marks upon the cylinder, when lying quite flat upon the rest, if the leading corner of the cutting edge, be held just free of the work, in the manner explained for the surface fig. 419. The work is perhaps rather liable to be turned taper, the exact traverse of the tool being less easy; and this mode of using the flat tool on the cylinder is hardly so suitable for truth of finish, as that previously described. A flat tool with the corners very slightly rounded, so as to stand just below the level of the cutting edge, may be traversed in like manner held perfectly flat upon the rest, without leaving any marks. This tool is occasionally used but is restricted to the plain external cylinder and surface; for, as the true straight edge of the flat tool applied to the work without lateral movement, produces a copy of itself, a tool which although to all appearance flat, does not produce a straight line, is a source of frequent inconvenience. The cylinder may also be turned smooth by the bevil tool, or the end of the right side tool; these are hardly so convenient as their shafts require a horizontal angle, in other respects their manipulation is similar to that of the flat tool. They are required for such purposes, as the internal corners and contiguous portions of the cylinder and collar, indicated by the dotted lines fig. 409. The tools travel down the surface, and arriving at the corner, are withdrawn cutting a short distance along the cylinder, and are then exchanged for the flat tool.

THE SURFACE.

The irregular surface at the end of the cylinder, may be turned flat and true with the gouge, held after the manner for softwood. Surfaces of small diameter, are turned with a smaller gouge, also lying on its side with its cutting bevil in coincidence, but held in the horizontal manner; the tool is pushed forward to the center, sliding against the left thumb, which serves as a stop to keep it in position. The manipulation does not materially differ from that for softwood, but more care is necessary to keep the bevil in coincidence, the hardness of the material giving the gouge a tendency to slide away from the cut.

A strong point tool is also convenient and much used, for first roughing the surface. For large surfaces the rest is placed rather high, that the point tool either in a long or short handle, may be held a little underhand; for smaller surfaces the tool is presented more nearly horizontally. In either position, it is supported on the front *edge* of the rest, the face

Fig. 411.

Fig. 412.

Fig. 413.

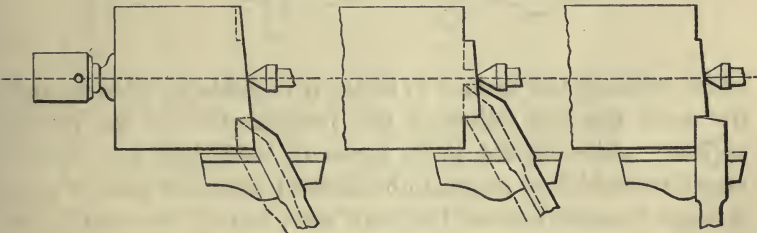

radial and slightly tilted on the left under corner of its shaft, with the left cutting bevil in contact with the work; gently twisting the shaft, varies the tilt, causing the edge to cut a shaving of greater or less thickness. Thinner finishing shavings, result from simple pressure of the cutting edge given by both hands, or, when the tool is held much underhand, by the pull of the left upon its shaft.

The irregular end of the cylinder forming the surface, is not usually at right angles to its axis, exaggerated in fig. 411, the first contact with the tool therefore varies, being deep on

the one side and perhaps missed on the other; such a surface is turned true a small width at a time. The point tool is first held to the work, with about a quarter, or three eighths of an inch of its cutting edge advanced to be within the margin. The tool is then made to travel, by pressure, laterally upon the rest, towards the end of the cylinder, its shaft retained in the same position; until, first engaging against the high side, which the intermittent cutting gradually reduces to the level of the low side, it has cut a ring sufficiently deep to become a true plane all around the edge of the surface. The point tool is then advanced towards the center to cut a second ring, in moderate surface agreement with the first, fig. 412, and so on until it reaches the center. If the tool be insufficiently held

Fig. 414.

Fig. 415.

Fig. 416.

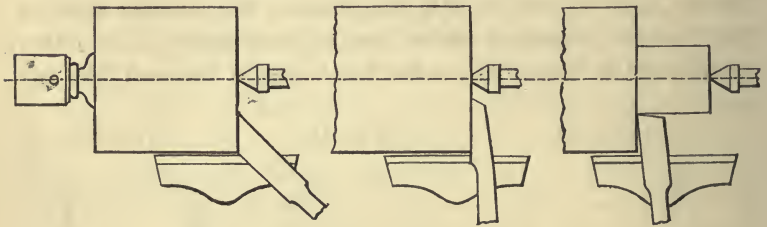

while reducing the surface to truth, it is liable to slide to and fro upon the rest following the irregularities of the rough surface; while should it be correctly held, but too rapidly urged towards it so as not to be allowed sufficient time to cut, it is apt to catch against the high side, tearing the surface or perhaps forcing the work out of the chuck. The irregular surface end of smaller work, may also be reduced to truth with the flat, or other rectilinear edged tool, fig. 413, applied upon the end of the cylinder. The left corner of the cutting edge is placed to fall within the lower angle formed by the face and the end of the cylinder, and the tool, held in the horizontal manner, is gradually advanced cutting continuously down to the center.

The rough surface produced by any of the foregoing methods, may then be turned smooth and flat, first by connecting the separate rings turned upon it nearly to one level, still by

separate cuts, under the guidance of the straight-edge; and then by continuous shavings, obtained by traversing the slightly tilted point tool, to and from the center. The bevil, right side, and side of the flat tool, figs. 414 to 416, are also used to finish the surface, the last, when it abuts upon a cylinder. When the work is supported by the popit head, the point or the bevil tool may cut quite to the center, but the cut is not then allowed to obliterate the center mark in the wood; the point of the popit head being slightly advanced, as the reduction of the surface requires it.

The surface is finished by a series of cuts, taken alternately from the center, halfway or two thirds towards the circumference and from the latter, over the remaining distance. The thickness of the shavings taken by each pair of cuts, being made gradually to diminish as they overlap each other, by reduction of pressure, by raising the handle, or reducing the tilt, according to the tool used; so that an equal amount is removed all over the surface, every time it is completely traversed by the tool. The traverse being also slightly quicker

Fig. 417.

Fig. 418.

Fig. 419.

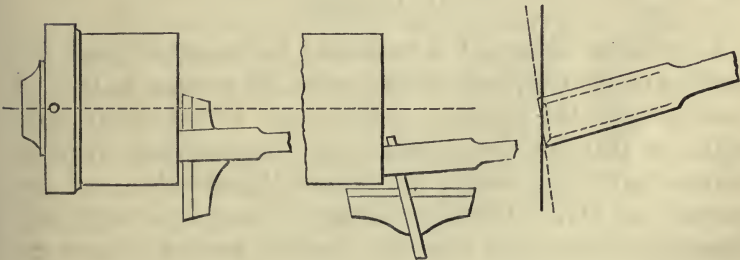

near the center and lingering near the circumference, to agree with the varying surface velocities, to equalize the amount of cutting action. Work that does not require the support of the popit head, may have the surface roughed in the manner already described, but is usually finished with the flat tool, with the rest placed at right angles fig. 417, or, with the flat tool supported on the arm rest.

The flat tool lies flat upon the tee rest, but to prevent its corners leaving marks upon the work, the straight cutting

edge is presented to the surface at a slight horizontal angle, nearly imperceptible except by its effects, but carefully maintained throughout the traverse. As the flat tool advances *from* the center, the cutting edge is inclined to give it a trifle more penetration at the right hand corner, exaggerated for illustration, fig. 419; the cutting action entirely ceasing about two thirds up the edge towards the leading corner, which is just free of the surface. In travelling from the circumference *towards* the center, the inclination is reversed, the left hand corner having the most penetration; a slight motion of the wrist reversing the inclination of the tool for each pair of cuts. When the surface approaches completion, the last finishing cuts are made to remove very thin shavings overlapping each other, with the horizontal inclination of the tool no more than sufficient to prevent the leading corners marking the work. In all the cuts starting from, or terminating at the center, the right hand corner of the cutting edge is placed *exactly* to it, and neither above nor below it; either of which positions, leaves a portion of the surface at the center standing above its plane, as high as the thickness of the shaving removed.

THE ARMREST.

In practical turning, it is constantly necessary to change the position of the tool, from cutting upon the surface, to that of cutting upon the cylinder or edge, and as constantly back again to that for the surface; the corresponding frequent change in the position of the rest is objectionable, and the position fig. 417, is therefore infrequent except for large surfaces or deep internal turning. Surface turning is also far more conveniently executed when the tool is under the guidance of the armrest, with the tee remaining parallel with the cylinder.

The *armrest*, fig. 420, is a smooth steel shaft, about seven to nine inches long by a quarter of an inch thick; the face is about half an inch wide at the handle, tapering to less than a quarter of an inch at the end, which is turned up square, fig. 421, to form a rectangular hook or stud. The handle is straight, and from thirteen to fifteen inches long. In use, the handle is held under the left upper arm close under the arm-

pit, pressed against the side, the blade lying flat upon and overhanging the rest, hook uppermost. The turning tool held in the right hand with the thumb and finger stretched out along it in the usual manner, lies on the armrest, the forefinger just touching the hook, which catches the side of the tool. The left hand grasps the pedestal of the rest by the three lower fingers, with the thumb pressed on the surface of the blade of the tool, lying on that of the armrest, holding both together down upon the tee. The left forefinger is bent like the other fingers around the pedestal, but is held just free of it, and

Fig. 420.

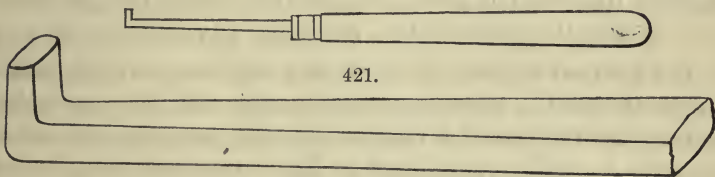

presses up, and supports the under side of that portion of the armrest blade that overhangs the tee; the position of the bent, second joint of the left forefinger under the armrest, being nearly and sometimes directly beneath the tool. The forefingers and thumbs of both hands, the ends of the tool and of the armrest, are thus all arranged together in one compact group.

The turning tool, although in contact with the hook, is held very nearly as before, cushioned between the inside of the right forefinger and the end of the left thumb; the armrest itself being supported on the tee by the grip of the left thumb, and the position of the handle under the left arm. The tee of the hand rest usually stands parallel with the cylinder and rather high, giving a sloping position to the armrest blade, which places the face of the tool about radial. The tool may be raised while cutting, by depressing the left shoulder or still more, by allowing the armrest handle to slightly drop, and then regripping it a little lower down the side. The cutting action is regulated by the independent lowering, and twisting of the handle of the tool *upon* the armrest, in the same manner as when it is upon the tee; and also by pressure from the

hands, or by the weight of the body, pulling upon the handle of the armrest.

This method of supporting the tool may appear formidable in description, but it is very easily acquired, and is often indispensable to the wood and brass turner. The armrest moving together with the tool across the surface, or within a surface curve, these are more freely traversed than when the tool lies on the tee of the rest; while in most internal turning, in which the tool considerably overhangs the tee rest, its edge is far more thoroughly supported, and easily and exactly guided when under the control of the armrest.

SECTION III.—BORING AND TURNING THE INTERNAL CYLINDER.

INTERNAL SURFACE, AND INTERNAL PARTING TOOLS.

The internal cylinder in hardwood and ivory turning, comprises all parallel apertures, commencing with the fine holes required for the insertion of pins or analogous purposes, which are made by drilling; followed by larger apertures, from about one eighth of an inch to about one and a half inches in diameter, which when comparatively shallow are produced with the turning tool, and when deep, also by boring; to those large openings often produced by the turning tool alone, but as frequently, commenced by boring and completed by turning.

Fine drilled holes of moderate depth, are conveniently bored with a drill made of a piece of round steel wire inserted in a handle. The end of the wire is flattened and slightly spread with the hammer, and then ground flat on the two sides, the cutting end is formed and sharpened with two bevils, meeting in a central point, the form of fig. 476, Vol. II. In common with other pointed drills, this requires a conical hollow center, to be made for its first entry in the work, fig. 357, which center is usually turned with a point tool. The pointed drill, as previously explained, does not keep a true line in boring deep holes; for these, the round steel wire is ground or filed away on one side down to the diametrical line, and sharpened nearly square across the end, forming the cutting edge as in the cylinder bit. This drill called a *pipe* bit, is used for holes from about one sixteenth, to one eighth of an inch in diameter, and from about six to twelve inches deep respectively. A conical center, just large enough to embrace its diameter, is

made for the first entry of the pipe bit, and, on account of its flexible nature, the bit is at first pressed into the work held by its shaft near the cutting end, supported between the thumbs and two first fingers of both hands. The handle is not grasped until the tool has bored to the depth of three or four inches, and then, the left hand continues to support the blade during its advance into the work. Both of these wire drills require frequent withdrawal from the work to clear them from the shavings, which, collecting upon their sides and ends as a hard substance, impede their cutting.

Internal cylinders, to about one and a half inches diameter, exceeding two or three times their diameter in depth, may be conveniently made by drilling. The *twist* drill, has a nearly parallel round shaft, with two spiral flutes opposite to each other along its entire length; the flutes form two cutting edges with two bevils, ground across the end of the drill, meeting in a central line, and the opposite end of the drill is provided with a hollow center. The twist drills may be used in a chuck, in a handle, or advanced by the point of the popit head, and are made to definite measures. The smaller sizes, to about a quarter of an inch diameter, may generally be used upon the solid material; holes of larger diameter, are gradually enlarged by several bits used in succession. The twist drill cuts after the same manner as the pointed drill, fig. 476, Vol. II., but more nearly true. The shaft nearly fills the hole by the cylindrical surfaces separating the flutes, so that the tool has considerably less tendency to escape sideways, and the hole, which is left pointed at the bottom, fig. 355, is much less liable to be bored inaccurately. The *fluted* drill, has two opposite straight flutes, parallel with its length, in other respects it is ground, used, and cuts, in the same manner as the twist drill.

The *cylinder bit*, called also the *half round* bit, fig. 507, Vol. II., bores a smooth, perfectly true hole, *flat* at the bottom; the bits are made to definite measures and range from about one eighth, to one and a half inches in diameter, and are from about four, to fifteen inches in length, respectively. The cutting end is first turned as a short cylinder, and then filed down to the diametrical line, leaving the section exactly, or not less than the half circle; the half cylinder

entirely prevents any lateral escape of the tool from the axial line, and also gives free egress to the shavings. The cutting edge is the angle formed by the diametrical face with the end of the tool; the end is ground nearly square across and nearly vertical, both to give the cutting angle, and to cause the line of the edge on the right hand side of the center, which does no cutting, to stand slightly behind the left hand or cutting half. The flat shaft of the bit has a hollow center at the opposite end for the point of the popit head, and the smaller sizes below half an inch, are convenient when mounted in wooden handles, which should be provided with metal hollow centers at their butt ends. The cylinder bits and others, are prevented revolving with the work by a hand vice or hooked wrench, temporarily fixed to their shafts, and held in the hand or allowed to lie on the rest; the smaller sizes have their handles grasped by the hand or a small lever is placed through a transverse hole in the handle, with the same object. They all require occasional withdrawal from the hole in process of boring, to remove the hardened shavings, which sometimes adhere to and impede their cutting edges.

The cylinder bit cuts principally by the left corner of its edge, from whence its action gradually diminishes to the center, which, with the other half is inoperative; it therefore requires a preliminary or clearing hole to be bored in the work, with one of the pointed drills, or with the *hand drill* fig. 459, Vol. II. The surface end of this hole is then enlarged with a right side tool, to the depth of about one sixteenth of an inch, the shallow recess formed being turned true, either slightly taper, or exactly to the diameter of the cylinder bit to be used. The one end of the bit is embraced by the true recess, and the other is supported by the point of the popit head, placing the bit exactly in the axial line at the moment it commences to cut, which position it maintains while boring to any depth. But it should be observed that in boring a hole, say of one inch diameter in hardwood, if it be attempted to use the one inch bit immediately after boring the clearing hole, the labor would be excessive, and both the bit and the work would heat from the friction, producing a roughened surface. The best result is attained by making the clearing hole about half an inch in diameter, and then using the three quarters, the

seven eighths, and the one inch bits in succession; each then cuts only by the most effective portion of its edge, and also, only upon that part of the work having the greatest surface velocity, which favourable conditions produce the aperture rapidly and leave a very smooth result. The extreme working difference advisable in boring hardwood or ivory, allows the holes to be enlarged to the extent of about one third their diameter, for cylinder bits below half an inch; one quarter or rather less their diameter, for those from half to one inch; and still less in the larger sizes. The limitation also saves excessive wear upon the bits themselves, preserving them for their other important purpose, that of boring true holes of definite measures in wood or metal.

TURNING THE INTERNAL CYLINDER.

Cylindrical openings to fit corresponding pins or short cylinders, for the purpose of attaching one part of the work to another, usually of inconsiderable depth compared with their diameter, are produced with the turning tool. The smaller are commenced by a fine hole, made by the wire drill first mentioned; the larger, by the hand drill fig. 459, Vol. II.; the aperture is then enlarged with a right side tool, fig. 390, used upon the armrest. The tool is very narrow for the smaller holes, being usually a small size so far worn away by grinding, that the line of the cutting edge and that of the back meet in a long point, such a tool being preserved for the purpose. Small internal cylinders below and about one eighth of an inch in diameter, are too small to permit their parallelism to be tested by the callipers; they are therefore gaged by the pin itself, which is turned first, quite parallel, and the internal cylinder is hollowed and fitted to it. The callipers are easily used within internal cylinders of about one quarter of an inch diameter, and either these, or their external counterparts may be turned first, as the progress of the work may render convenient; the more general and safer practice however, is to turn the aperture first and to reduce the pin to fit it.

Internal cylinders from about two inches diameter upwards, may be roughly hollowed out with the gouge, used exactly as described for the same purpose in softwood; but, as hardwood offers greater resistance to the tool, the gouge is only suitable

for shallow works. The method fig. 422, applies to all depths and is more general. A hole is first bored with a hand drill to a depth about one eighth of an inch less than the intended length of the cylinder, that the mark left by its point, may be subsequently entirely turned away in finishing the internal surface. A right side tool held upon the armrest, is inserted in the hole and pulled towards the circumference, a succession of such cuts, removing the material to the bottom of the hole made with the drill. The traverse of the tool is principally effected by poising the weight of the body backwards to pull upon it, the rate, being gradually retarded from the center to the circumference, to allow the tool time to cut upon the increasing surface.

The depth to which the right side tool should enter the hole for every separate cut, varies with the hardness of the material, and the diameter of the work; two or three narrow cuts of about the eighth of an inch, the average width, being made in

Fig. 422.

Fig. 423.

Fig. 424.

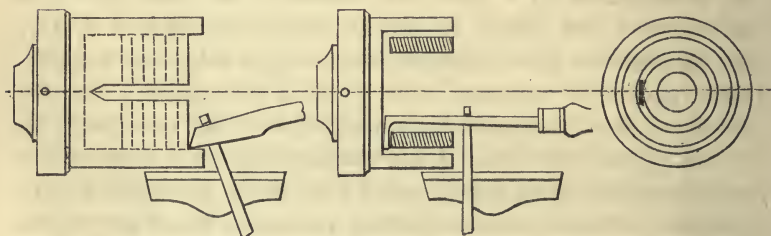

less time and leaving the work smoother, than when their combined width is taken as one cut. The tool is supported upon the armrest its edge held radial, by both hands in the usual manner, except in heavy roughing cuts upon large work, when the left hand is frequently withdrawn from the pedestal of the rest and clasped upon the shaft of the armrest, thumb uppermost, to assist in pulling the tool into cut. As the cylinder increases in depth, the right side tool more and more overhangs its point of support; raising the tee of the rest then affords some additional command over the tool, its shaft and that of the armrest then both slope a little downwards, more in the position of a tool held underhand. Large and deep

cylinders are commenced in the same manner, and when they become beyond the convenient use of the armrest this and the tool are exchanged for a strong right side tool in a long handle, with the tee placed as in fig. 417, and sufficiently below the center to place the face of the tool about radial. The operator stands nearly facing the mouth of the cylinder, with the handle of the tool tightly pressed between the right upper arm and the side, just above the elbow. The blade of the tool is grasped by both hands, pressed closely together, one in front of the other, the right hand *against* the chest with the thumb, and the left hand with either the thumb or the knuckles uppermost. In this position, the shaft of the tool is at a slight horizontal angle in front of the right chest, lying flat upon the rest; and the separate cuts are made partly by the weight of the body, and partly by muscular pressure given on the side and also in the direction of the length of the tool.

The internal cylinder is finished, and the irregularities left by the separate cuts are connected into one straight line, by continuous shavings taken from the bottom outwards; the bottom or internal surface, being usually turned true or flat at the same time. During the finishing the cylinder is frequently measured with the inside ends of the callipers, fig. 342, and enlarged, by more frequent shavings at the back or front end, as may prove necessary. For works of moderate size the tool is used under the guidance of the armrest, but it no longer remains only in simple contact with it, as in the roughing cuts; but sometimes, more especially in traversing the deeper end of the cylinder it slides upon it, the shaft of the tool being drawn outwards by the right hand, while the armrest blade remains nearly stationary on the tee of the rest. The armrest takes up the motion as the cut nears the mouth of the cylinder, the tool then ceases to slide upon it, and is moved while cutting by the lateral traverse of the armrest upon the tee. For finishing large, deep works, the larger tool is supported on the tee alone, which is placed across the mouth of the cylinder.

In cutting these continuous shavings, the edge of the right side tool is apparently parallel with the side of the work, actually, it has a trifling horizontal inclination to prevent the

corner leaving marks. The extreme end corner having slightly the most penetration, sufficient to cause the cutting action to diminish, and to cease entirely about half an inch down the side edge. The same amount of horizontal angle is maintained throughout each entire traverse, but less is required for the finishing cuts, when the straight side of the cylinder itself as it approaches truth, greatly assists the correct guidance of the tool. The continuity of the shaving is maintained by the pressure of the right hand upon the tool, always assisted by a gentle pull upon the armrest, whether the tool be stationary or sliding upon it. The thickness may be varied, by varying the pressure or by slightly twisting the handle of the tool while cutting, to give the edge more or less penetration.

THE INTERNAL SURFACE.

The internal surface, when its accompanying cylinder is of moderate depth, is turned with the flat tool and armrest. At increased depths, the tool is used in a long handle; it may be

Fig. 425.

Fig. 426.

Fig. 427.

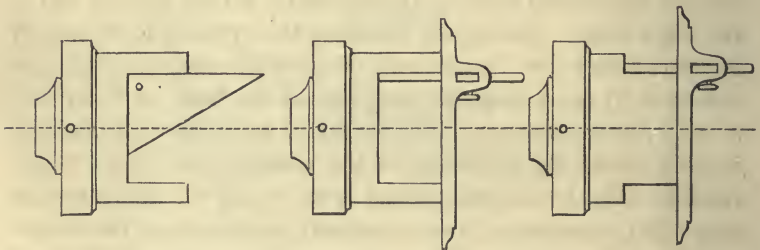

held upon the armrest in the usual manner, or its long handle may be held directly beneath the right fore arm, which then *presses* upon it. For still greater depths, a strong, long handled flat tool is used upon the tee rest alone, placed parallel with the work. The management of the tools is the same as that described for the external surface.

The internal surface and cylinder are finished together, to produce their internal corner. This is readily formed, for the sides and cutting ends of the flat and right side tools, being less than right angles, their cutting ends when working upon the surface, may be carried to the extreme circumference or corner,

without their sharpened sides touching the cylinder. While in like manner, their sides may advance cutting to the extreme end of the cylinder, without their cutting ends taking effect upon the surface. The tools may therefore be applied, each to its particular superficies exclusively, or either tool may travel along that into the corner, and then by alteration of the horizontal angle at which it is held, it may be withdrawn, with its side or end cutting along the other. The truth of the internal surface and the accuracy of the corner formed with the cylinder, are tested by a small steel square, fig. 425, or by the turning square with sliding blade, which also transfers the measure for the depth in fitting one piece to another. The stock of the turning square, is held in contact across the mouth of the aperture, and the steel blade at right angles to it, is pushed down until it touches the surface fig. 426; the greatest depth is then sought, by traversing the blade of the turning square from the edge towards the center, the blade is then fixed by the set screw, and the whole surface reduced to this level.

INTERNAL PARTING TOOLS.

The internal cylinder when of ivory or rare woods, may be roughed out in solid pieces, in the manner referred to in the first volume for the preparation of ivory; the material being removed and saved for use in the form of rings and cores. Short cylindrical apertures completely through from one face of the work to the other; may have the center or core cut out as a solid with the parting tool, fig. 389, held horizontally and parallel with the axis of the lathe; cutting from one surface of the work only. When the thickness of the piece approaches two inches, it is more convenient and less wasteful to chuck the work twice, making an incision of only half the depth from each face. The parting tools employed vary with the size of the work, from about a thirty second, to an eighth of an inch in width, and from about a quarter to half an inch in depth; they are used with and without the armrest, the smaller in short and the larger in long handles.

The parting tool soon binds and then becomes fast in the narrow circular groove made by a single cut, to which the flat side of the tool lies as a chord. Immediately it commences to

bind therefore, the tool is withdrawn, and re-applied to cut a second groove by the side of and merging into the first, fig. 424. The widening of the groove allows the tool to act freely, and the two cuts are alternately prolonged until the work is pierced completely through. A groove less than twice the width of the tool, usually suffices for works that are comparatively large in diameter and of no great thickness; but greater width is required in small cylinders, from the increased curvature of the circle compared with the straight line of the side of the tool. In deep grooves, even when they are of large diameter, the separate cuts are not very easily kept distinct; the sides of the curve having a tendency to become taper. Such grooves are widened, by additional cuts near the surface, while at the bottom, their width is hardly greater than that of the edge of the tool itself, the form conveniently admitting the increasing thickness of the shaft of the parting tool, with which it nearly agrees in section.

Cylinders closed at one end, have the material removed as a series of rings, one from within the other. The *inside parting* tools, fig. 391, are employed to cut a surface groove in the body of the work, fig. 423; the diameter to which this surface groove extends, is then noted and marked on the face of the work, and a cylindrical groove, cut down from the face in the manner last described, meets it and separates the ring. An aperture is previously turned or bored in the work to the depth of the required cylinder, and equal in diameter to the width of the inside parting tool, measured from the cutting edge to the back of the stem. A tool having a short blade, requiring a hole of small diameter, is first used to remove a thin ring; the increasing diameter of the aperture, then admitting tools with longer blades, removing thicker rings.

The narrow and comparatively long blade of the inside parting tool, fig. 391, has much greater depth than width, and stands at right angles to its shaft, which is held *parallel* with the mandrel axis. Should the shaft be inclined horizontally, the long blade binds against the sides of the groove in the direction of its length, but if vertically, then by its sides or depth; the slender blade gives but little warning, and may be

readily broken off if the tool be used with too great force, or if it bind sensibly in either direction. The accident should not happen if the shaft be held fairly parallel.

The tool in either a short or long handle is held upon the armrest after the horizontal manner, its shaft pressed against the hook by the left thumb; but, as the cutting edge is at a distance from its point of support according to the depth of the cylinder, the right hand is correspondingly shifted back down the handle of the tool. The shaft is supported on the armrest at a point about one third from the cutting end, between that, and the right hand upon the handle, this gives increased power for the guidance of the tool, and allows any divergence of the shaft from parallelism with the mandrel axis to be readily seen and prevented. A slight upward twist is also constantly maintained upon the handle of the tool, to keep the blade in its correct cutting position; the resistance of the cut having a tendency to force it to fall below the radial line; and the cutting pressure is principally given by the weight of the body, gently poised backwards. When the depth of the cylinder is too great for the armrest to give sufficient control, a long handled tool is employed upon the tee, placed at right angles; the tool being held in a similar manner to the right side tool in roughing out deep internal work.

The blade of the inside parting tool tapers from the cutting edge in both directions, giving sufficient clearance for thin rings to be separated by a single cut; but this taper is insufficient for thick rings, when to avoid friction, the groove requires to be about one and a half times the width of the blade. The tool is then allowed to cut the first groove to a moderate depth, withdrawn entirely clear of it, and re-applied, shifted up the cylinder about half its own width; here, a second cut is made, merging into and nearly to the same depth as the first, but leaving a step. The tool is then returned to the first groove to increase its depth, and then again transferred to the step for the second, the two cuts being continued alternately until the widened surface groove is of the required depth. The increased width given to the groove, materially assists the escape of the shavings, but these especially in ivory, nevertheless frequently collect and form a small hard obstruction at some spot at the bottom of the groove. The accumulation,

which is immediately felt by the blow it gives to the edge of the tool at every revolution, cannot be removed by force; and if it be neglected rapidly increases, frequently forming a sufficient obstacle to break off the blade of the tool. The shavings will also sometimes collect in a similar manner, at the bottom of the groove cut from the surface by the ordinary parting tool. Directly the blows are recognized, either tool is withdrawn from the bottom of its groove, and only sufficiently re-advanced to attack the top of the obstruction; this is then easily reduced and removed by the intermittent action, when the tool arrives again at its former depth and once more cuts all around the groove.

SECTION IV.—EXTERNAL AND INTERNAL CONES.

The material for the hardwood cone is first turned fairly cylindrical, nearly to the diameter of the base, and the end surfaced; the height of the intended cone is then marked off upon it, measured from the base, at the chuck end. Should the work be carried between centers or be of sufficient length to require the support of the popit head, the height is marked a little in excess to allow for the small reversed cone to receive the point of the latter, turned away in the course of the process, as explained for turning this solid in softwood.

The management of the tools differs so slightly from that for the cylinder, as to require but little notice. The work is first roughly reduced to the conical form by the gouge, held and used as upon the cylinder; the tee of the rest being from time to time placed parallel with the side of the work, as that gradually assumes the conical shape. In finishing, the tee is fixed parallel with the side of the cone. The work is turned smooth with the flat tool, first by separate cuts and then by continuous shavings, taken always in one direction from the base to the point, or downhill; when the tool, cutting obliquely across the ends of the fibres, leaves the surface smooth and finished.

The internal cone is first roughly hollowed in much the same manner as the cylinder; the separate cuts are then connected into one line, by the right side, point, bevil, or flat tools, according to the angle. In finishing, the correct angle is ascertained by the turning bevil fig. 376, placed across the base

or mouth; the steel blade enters the cone, and a large portion of the side can be turned to be truly in contact with it. The part turned to the true angle, then serves to guide the straight edged tool in continuing the same line into the apex. A right side tool, the cutting edge so far ground away as to meet the back in a point, is used for the apex of acute internal cones; more obtuse, fig. 428, may be entirely finished with the bevil tool, and truncated cones with the flat tool, all the continuous shavings being removed from the bottom outwards.

Tapering forms of the character indicated by figs. 429. 430, their outlines produced by concave or convex curves, are frequently required in hardwood turning, and may be considered as allied to the cone. They are produced in a similar manner

Fig. 428.

Fig. 429.

Fig. 430.

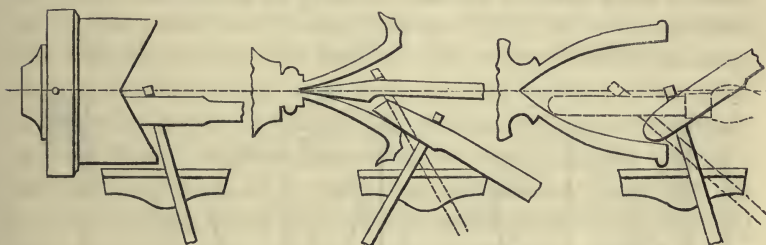

with the right side, point or round tools, smaller tools being employed upon the narrower portions of the hollow. The tools are nearly always used upon the armrest, the shavings after the first rough hollowing, being taken from the center towards the orifice.

SECTION V.—THE SPHERE AND INTERNAL HEMISPHERE.

The sphere in hardwood may be produced after the same polygonal method, described for softwood. The material should have the grain running lengthwise, agreeing with the mandrel axis; and when carried in a plain chuck, should be of a length equal to about one and a half times that of the diameter of the proposed sphere, to allow a sufficient space for the management of the tools. Short pieces, of a length little more than sufficient for the diameter, may be mounted between

centers, but these are rather inconvenient and leave marks upon the work.

The work is first turned exactly cylindrical and surfaced, and then marked to a length equal to its own diameter, by a fine line struck on it with a point tool. The measure of the diameter being carefully taken with the callipers, and retained for further use. The material beyond the mark is then roughly reduced, to permit about two thirds of the back surface to be turned accurately flat, with care not to diminish the length marked. The resulting cylinder, is then exactly divided in length, by the line c. d. fig. 431, struck upon it with a *pencil*. The two ends of the cylinder are next reduced to a series of short cones or facets, under the guidance of the bevil, on the system explained for the softwood sphere; the flat tool held horizontally, replacing the chisel. The sphere is blocked out, on both sides of the line c. d., by as numerous a series as

Fig. 431.

Fig. 432.

Fig. 433.

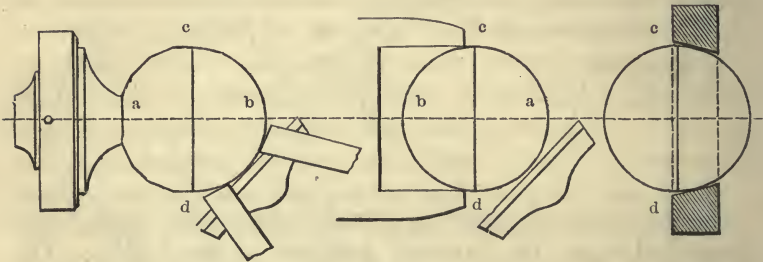

possible, continued on the surface side to the center, and on the chuck side, down to the neck; the angles formed being divided again and again, so as at last very closely to approach the spherical form by this means alone. The flat tool is then swept around the hemisphere, d. b. fig. 431, to merge the separate cuts into one continuous line; the gradual, equal disappearance of the flats and angles serving to guide the first traverses of the tool, which is not permitted to obliterate the pencil line c. d., nor to encroach upon the exact center of the old surface at b., both of which remain component parts of the curve. The facets may be both more numerous and more accurately turned than upon softwood, and the system is carried out with greater ease. The tool requires none of the

complex changes of position necessary to the chisel, but lies always flat upon the rest, its edge a tangent to the circle around which it travels, cutting only by the point of contact. The traverse is almost entirely effected by the motion of the right wrist, the arm moving but slightly upon the elbow as on a center, the fingers of the left hand around the pedestal of the rest, the left thumb following or preceding the tool in guiding it around the curve.

The spherical form when attained, is only preserved by the equal reduction of its superficies, that is, by the equal thickness of the shavings removed from all around the hemisphere at each complete traverse of the tool; which depends, not only on the pressure, but also upon the ratio of the traverse of the tool to the surface of the sphere. The surface is greatest at *d.*, where the shaving is removed around the circumference, and least, in the neighbourhood of *b.*, where the tool cuts upon a small and continuously diminishing circle; to accommodate this varying surface, the rate of the traverse is continually accelerated in passing from *d.* to *b.*, and retarded from *b.* to *d.* Practically, the tool does not traverse the entire curve; it is swept around it about two thirds from *d.* to *b.*, with slightly increasing speed, and towards the termination while still in contact with the work, it gradually ceases to cut by diminished pressure. The tool is then placed at *b.*, and swept in the opposite direction, with decreasing speed, around rather more than the remaining one third of the curve, the pressure as before diminished towards the termination, that the two cuts overlapping, may still remove an equal thickness all around the curve. As the hemisphere approaches completion, the equal traverse for the light finishing shavings is very much assisted by the sense of touch, which then readily detects any variation in the contact.

The first hemisphere completed, the series of cones forming the second is continued a little nearer to the center, the reduced neck is cut through with a parting tool without encroaching on the length *a. b.*, and the sphere is re-chucked by its finished side in the boxwood plain chuck, fig. 432. The chuck is previously turned true upon its surface edge and in the hollow, the latter very slightly conical or about 2° , and large enough for the internal arris to fit the finished sphere

about 10° to 15° from its circumference. The work is pressed into the chuck by the fingers, with the pencil line previously struck around c. d., adjusted to run truly with the true face of the chuck. A flat surface is then turned at a., until, as measured by the callipers, left set at the diameter of the original cylinder, the length of the axis a. b., is found to exactly agree with the diameter of the circumference, c. d.; the work being frequently removed from the chuck for measurement, during the process.

The finished hemisphere being concentric with c. d., this line must again run exactly true to turn the second, that both may be concentric or upon the same base. When therefore the length of the axis is determined, the sphere is replaced, with increased care in the agreement between c. d. and the face of the chuck; the lathe being set in gentle revolution while adjusting, that the line may be observed to be running truly or otherwise. The adjustment is made by pressure from the ends of the fingers, given upon one or the other side of the work. One side of the line may be easily forced too close to the chuck in the process, and be fixed beyond the power of correctional pressure on the other; the sphere in that case, is released and the adjustment recommenced. When satisfactorily true, the work receives one or two light blows from a mallet or from the end of the armrest handle, poised horizontally, which, delivered centrally at a., do not disturb its truth, but increase its security. The series of cones is then completed to the center and the second hemisphere turned and finished in the same manner as the first; without obliterating the pencil line c. d. nor reducing the exact center at a.; the original diameter and length of the cylinder, and the gages determining the size and truth of the sphere. The work is released by the hand placed around it, close against the face of the chuck, pulling against the thumb on the side; if too large to be thus grasped by the hand, or if too securely held, a light blow from a mallet or even from the clenched hand delivered on the side of the sphere, a little beyond c. immediately releases it.

The ring gage fig. 378, described upon the softwood sphere, may be also used as an additional precaution against any undue reduction of the curve, or to detect any accidental entry

of the tool below the true line. There is however less risk of the latter, hardwood being more suitable for the formation of the sphere, and the manipulation of the flat tool being much easier, than that of the chisel. A larger ring gage, fig. 433, accurately turned in metal, taper inside and sufficiently large to embrace the sphere, may be used to test it when removed from the chuck. This gage is more frequently used for testing spheres of greater accuracy, usually made by the method followed in turning the billiard ball, described in Chapter XI.; the sphere is rotated within the ring in all directions, the line of light between the two showing its condition as to truth.

INTERNAL HEMISPHERE.

All dimensions of the hardwood internal hemisphere, may be produced with the round tool fig. 392. The smallest do not usually require much accuracy, and these little cavities may be made as counterparts of a round tool, the width of

Fig. 434.

Fig. 435.

Fig. 436.

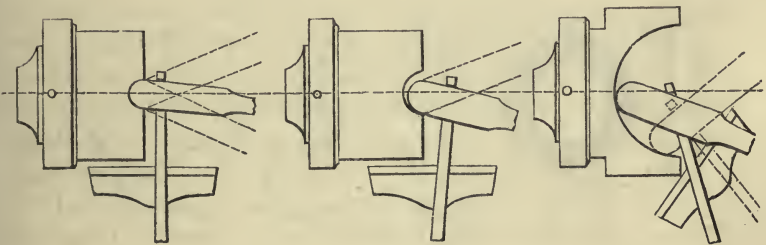

their diameter. The tool is held upon the armrest, with its cutting edge exactly to the height of center, and the first penetration made with the shaft at a small horizontal angle, fig. 434; afterwards, the tool is made to swing upon its edge in both directions about as far as the dotted lines. The round cutting edge moving upon itself, produces a smoother hollow and prevents any inaccuracy in the curve to which it may have been ground, from being reproduced in the work. Hemispheres a little larger than the tool, fig. 435, are turned in the same manner, but the tool touching only one side of the hollow, can be moved with greater freedom.

Larger internal hemispheres are roughly hollowed out with the gouge, as used for the internal cylinder, and finished with a large round tool freely swept around the curve to and from the center; the finishing or smoothing cuts, being all taken from the center outwards. The tool is held in the horizontal manner, the shaft at a small vertical angle, with the rest fixed sufficiently high to cause the traverse of the cutting edge to be about radial. Its radial position should be exact at the center, to avoid leaving the slight projection which follows in all surface turning, when the cutting edge of the tool is either above or below the center of the work.

A thin accurately turned ring or plate of wood, fig. 437, marked with a diametrical line, its external diameter the same as that of the required hemisphere, is used from time to time to gage its truth. Applied edgewise within the cavity, it detects those portions of the curve that are too prominent and prevent its complete entry, and also those at which the curve

Fig. 437.

Fig. 438.

Fig. 439.

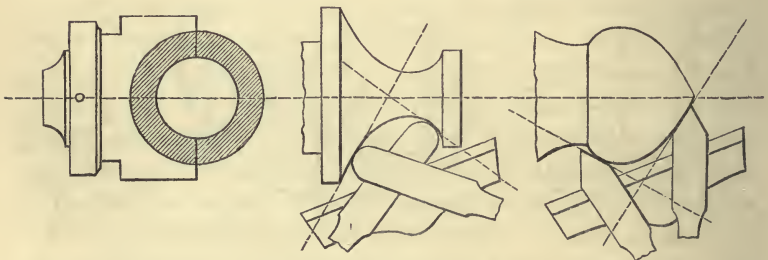

has been turned away below the true line. The former are gradually corrected, until the curve in the work exactly agrees with the gage; to correct the latter the entire curve has to be turned deeper, to the greatest depth the tool has any where entered upon it, and the face of the work then reduced to agreement with the diametrical line on the gage.

Concave curves upon the cylinder, such as fig. 438, are allied, being produced in the same manner, except that the tool is supported on the hand rest. The thin ring or plate, fig. 437, of suitable size, but usually without the diametrical line, is again advisedly used to gage the path of the tool,

upon all such curves as are portions of circles; the accuracy of the curvature thus attained, as mentioned later, being a considerable element in beauty of form. The reverse, convex forms fig. 439, like the sphere, are produced with tools having rectilinear edges, which in cutting, as indicated by the dotted lines, are also always tangents to the curve under formation. The acting portion of the cutting edges of the round tools, occupy a similar relative position to the concave curve during all parts of their traverse. Curves greater than the internal hemisphere are commenced with the gouge and round tool, but the latter soon requires to be supplemented by the inside tools, figs. 400 to 403, with which the curve is continued in the returned or undercut portions.

CHAPTER IX.

ELEMENTARY METAL TURNING.

SECTION I.—INTRODUCTION. TOOLS IN COMMON USE FOR TURNING STEEL, IRON AND BRASS. PREPARATION OF THE MATERIAL. SPEED AND DEPTH OF CUT. LUBRICATION.

THE manipulation of the hand turning tools for metal, in many particulars greatly resembles that of the tools employed both upon hard and softwood, while the analogies between the cutting action of the wood and metal tools, are generally close and apparent. The correct management of the turning tool however, can be far more readily appreciated in wood than in metal turning, on account of the more decided and visible cutting action exhibited in the removal of the wood shaving, and also, from the more tangible, successful or faulty results obtained upon the work. Whence it is found that success in hand turning in metal is more easily acquired, if preceded by a moderate proficiency or even some little practice in turning wood.

Some of the analogies between the metal and wood turning tools, have been pointed out in the second volume, and with some others, will be recognized in the following pages and in practice; although they may be to some extent obscured, by the different modes of holding the tools and the different cutting angles, necessary from the increased hardness of the material. The latter circumstance also very greatly reduces the quantity removed by the tool at each individual cut; but on the other hand in metal turning, less of the material usually requires reduction. Unless the finished work nearly approaches the cylindrical form, it is seldom produced direct from the cylinder by the removal of the superfluous portions, so convenient a mode in wood turning. A near approach to the form is usually first given, either by forging or casting, and the use of the turning tool is thus limited to reducing the different superficies to their required dimensions and concentric

truth. The slide rest with a fixed tool is very generally employed for turning metal, and by its rapidity and truth of execution, largely supersedes the more painstaking use of the hand tool. The lathe may however be unprovided with this valuable adjunct, while for many works its use may be neither convenient nor necessary, so that a large quantity of metal work remains that requires execution by the hand turning tool alone.

The more general of the forms turned in metal are principally composed of the external cylinder and surface; very frequently, several different dimensions of both superficies, together with others, being combined more than once in the same solid. Cones and curves are less frequent; the first being usually working fittings and centers of motion; curves, being very generally employed merely to connect the cylinder to the surface, to break an external or internal corner and for ornament. The internal forms are the corresponding apertures, the smaller, produced by boring or drilling, the larger being generally first cast or forged in the material; both are enlarged or finished to size with the turning tool, and sometimes by grinding or other means as required. The above mentioned plain forms, and a few familiar examples of their combination, are proposed as illustrations for the manipulation of the hand turning tools for metal. The different methods of chucking these various forms will be found in a preceding chapter.

TOOLS IN COMMON USE FOR TURNING STEEL, IRON AND BRASS.

The cutting angles of the tools for turning iron and steel, vary from 60° to 80° . The most general, shown on the face and in profile, figs. 440 to 449, are usually ground at about 60° , and are used direct from the grindstone. Occasionally, for fine finishing cutting, they are set at a slightly increased angle on the oilstone; for both which processes, see Vol. III. pages 1136—1146. The tools are to a great extent used in long or short handles according to their size.

The *graver* figs. 440. 441. is of square section, it cuts on either side by the portions close to the point of the two adjacent sides of its lozenge shaped bevil; but not by the actual point. For use with the lathe the graver varies from about

one eighth, to about half an inch square. The extreme point may be strengthened and saved from the risk of accidental fracture, by just touching it upon the stone, to grind a minute facet at an angle to the principal chamfer. The watch turner uses the side edges and also the point of similar tools of very small size, with the turn bench, fig. 28; these small gravers are also made of lozenge section, to give the rhomboid of the cutting chamfer a more acute form; they are used both for turning and engraving.

The three sides of the *triangular* tool, figs. 442. 443. are ground flat and to a slight curve in the direction of their

Fig. 440. 441. 442. 443. 444. 445. 446. 447. 448. 449.

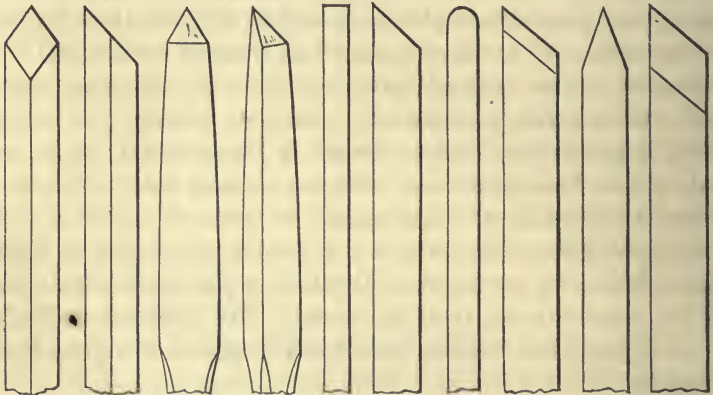

length; much like the form of a triangular file, from which the tool is often made. The triangular tool is of about the same dimensions as the graver, the end being also ground off at about the same angle. Unlike the graver; the triangular tool cuts almost exclusively by the three angles of its sides or shaft; sometimes the side edges of its triangular facet are used, but not the extreme point.

The *flat*, *round*, and *point* tools figs. 444 to 449, vary from very narrow, to about half an inch in width on the face; the smaller sizes being usually of much greater depth than breadth. These tools are used to finish the work after it has been rough turned with the graver; the first, upon the cylinder, surfaces, and convex forms, the round tool for

concaves, and the last for grooves, beads, edges and surfaces. The hook or heel tool, figured and its manipulation described, together with some other less general metal turning tools, page 525, Vol. II., is a powerful and very useful tool for iron; its cutting position is precisely analogous to the wood turner's gouge, the hook tool however, being directly supported against the cut by the tee of the rest instead of the hands.

The ordinary hand tools for turning brass, gunmetal and similar alloys, shown upon their faces and in profile figs. 450 to 460, are both narrower and thicker than the corresponding forms used for hardwood; they are mounted both in long and short handles. The cutting edges are ground at an angle, varying from 60° to 70° with the face, and are set on the oil-stone, at the more obtuse angle of from 80° to 90° ; the right angle having the preference for the finishing tools.

The *router* or *routing* tool figs. 450. 451, a narrow round tool, varies from about one sixteenth to one quarter of an inch in width, the smaller sizes being considerably thicker than they are wide. The router is used to rough away the exterior upon the cylinder, surface, and curved forms, and to turn small hollows or concaves, and may be considered as a solid gouge.

The *flat* and *round* tools for brass, figs. 452 to 456, range from very narrow to about three quarters of an inch in width, and are from about a sixteenth to a quarter of an inch in thickness; they are ground and sharpened to cut both upon their sides and ends, and are used subsequently to the router to smooth and finish the turned surfaces. The *point* tool figs. 456. 457, is of similar dimensions and is used for surfaces, edges, beads, and grooves; sometimes the extreme point is slightly rounded and the tool used to replace the router. The *square* tool, fig. 458, frequently ground out of an old square file, has all its four faces and angles alike, the sides like those of the triangular tool for iron being very gently curved lengthwise. The square tool is used upon the surface, and upon the internal cylinder, when it is usually supported on the armrest. Strong, narrow, right side tools, fig. 390, ground to the appropriate cutting angle for brass, are also much used for internal

work, and the hardwood parting tool, fig. 389, may also be employed.

The *milling* tool, figs. 459. 460. consists of a small, solid, hardened steel wheel, from about half to three quarters of an inch in diameter, generally less than a quarter of an inch in width but occasionally very much wider, revolving freely on a steel axis in an iron stem; the edge of the wheel may be flat, concave or convex as required, and is impressed or cut with fine or coarse lines or devices forming a pattern. The milling tool is held against the revolving work, with which it is placed in forcible contact by pressure and by lowering the handle; it imprints its pattern partly by compression, and partly by

Fig. 450. 451. 452. 453. 454. 455. 456. 457. 458. 459. 460.

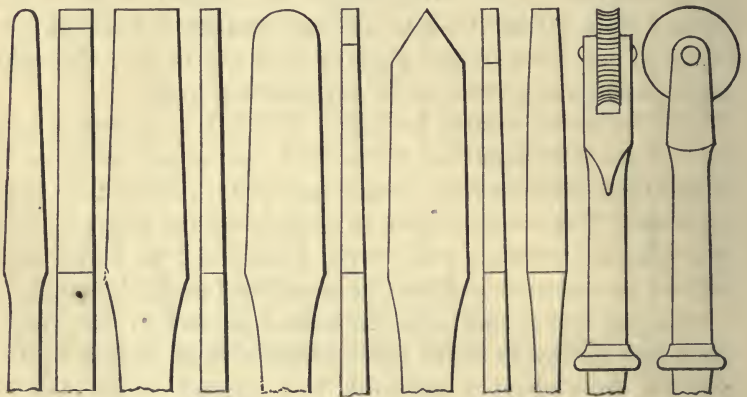

nibbling away or abrading the sides of the indentations it forms on the work. The compression exerted first causes a series of slight indentations somewhat like the teeth of a cogwheel, but the teeth or ornament upon the milling tool not being of a form admitting of purely rolling contact, a scraping or abrasive action then commences; this secondary action being enhanced by the circumstance, that the work and the tool usually travel at very different angular velocities, the one being generally of much larger diameter than the other.

In using the milling tool the pressure is at first given moderately, and then gradually increased until the perfect pattern appears, which arrives so soon as the action has

slightly, but sufficiently reduced the diameter of the work. The milling tool is then withdrawn as its further use would unduly reduce the diameter upon which it operates, and if continued, blur or disfigure the pattern. Similar milling tools are used either upon iron or brass; upon the latter they will endure a considerable amount of work but they are quickly worn out upon iron or steel; separate tools are therefore reserved for iron and for brass, as a worn tool makes but little progress even upon the softer metal. The milling tool is sometimes applied to wood, much of the German toy turnery from the Black Forest, being very effectively ornamented with it. It is also employed in this country for ornamenting porcelain and terra cotta; the wheel then called a "runner," is an inch or an inch and a half in diameter, and is made of hardwood.

PREPARATION OF THE MATERIAL.

The hard exterior of both castings and forgings rapidly deteriorates the cutting edges of the turning tools; while, in addition to their hardness, the surfaces of most castings are much impregnated with the sand of the mould, which is as destructive acting upon the tools after the manner of a grindstone. The materials therefore undergo some preparation, before they are submitted to the action of the tools in the lathe.

Iron castings that are sufficiently in excess of the finished size of the work, sometimes have the exterior removed from those parts that are to be turned by the hammer and chipping chisel, page 850, Vol. II. This method however, is neither suitable nor convenient in all cases, and when inapplicable, the exterior of the casting may be cleansed from the sand with acid. Iron castings of large size are plentifully wetted from time to time during a few days, with a mixture of about one part of sulphuric acid to three of water; dabbed on with a kind of mop, made of strips of cloth attached to the end of a stick, or bound together by a twisted hazel or willow rod, as a handle. The castings are afterwards well washed with water and scrubbed with a stiff birch or wire broom, to remove the sand from the corroded surfaces. The "pickling," unless carefully carried out, will however still leave portions on which the sand

remains sufficiently to be objectionable; and if their size be not too large, it is a much better practice to completely immerse the castings for about twelve to twenty-four hours, leaving them suspended or standing in a bath of the above mixture, about three times diluted, the castings being well washed and scrubbed on their removal.

Brass and gunmetal castings when treated in the same manner, page 375, Vol. I., are placed in a bath of nitric acid, mixed with from four to six parts of water. They may also have the sand removed from their surfaces with an old file. After the cleansing by either method, brass and gunmetal castings are generally held upon the anvil, and equally hammered, to increase the density of the metal to improve its elasticity and tenacity.

The hard external scale left by the hammer and fire upon forgings, should be reduced with an old file or removed upon the grindstone; more especially from about the edges or those parts where the cut will be commenced, that at its first entry, the cutting edge of the tool may only encounter the clean metal. Steel bars or forgings are *annealed* or thoroughly softened as a first step; the process being to heat them to redness and then excluding access of air, to allow them to cool as gradually as possible. After the heating the forgings to be annealed are sometimes left in the center of the fire, which is banked or carefully closed all around them, the entire mass being left undisturbed until it has become perfectly cold. Small objects liable to be lost in the fire, may be enclosed in a sheet iron box or tube. Larger pieces placed in the naked fire, when uniformly heated to a dull red heat, are also sometimes withdrawn and placed on a deep layer of thoroughly dried or charred sawdust, or charcoal dust; they are then at once closely covered up with the same material to the thickness of three or four inches, the whole being left undisturbed until cold. When annealed, the exterior of the steel forging is cleansed with the file or on the grindstone, as with those of iron. Many engineers carefully anneal all small forgings whether of iron or steel, and afterwards pickle them, as with cast iron, but for a longer period. This practice is followed to entirely remove the coat of black oxide, driven hard into the surface in the forging, and its adoption causes the edge of the

tool to remain in cutting condition for a much longer period than would otherwise be the case.

SPEED. DEPTH OF CUT AND LUBRICATION.

Owing to the increased strain and friction in metal, compared with wood turning, considerably reduced speed in the revolution of the work is generally necessary, this is requisite, to allow sufficient time for the severance of the turnings, to avoid the risk of tearing the surface of the work, breaking the point of the tool, or unduly heating and softening the temper of its cutting edge, or of damage to the lathe itself. The particular speed most suitable to any one metal and set of circumstances, also slightly varies as explained in wood turning, in proportion to the diameter upon which the tool is cutting.

In turning cylindrical work of iron or steel from about two to four inches diameter in the foot lathes described, the driving band is usually placed to run from one of the grooves of smaller diameter of the slow motion or second bevil of the fly wheel, to one of the larger, upon the mandrel pulley. The diameter of the former, not generally much exceeding twice that of the latter. This proportion is frequently reduced with advantage, the fly wheel being often provided with a third bevil of much less size, fig. 110, to be used for turning large work; the mandrel may then revolve almost turn for turn with the fly wheel. The speed in all cases being again somewhat susceptible of variation, by the slower or quicker use of the treadle. Iron and steel work of less diameter may be driven at a little increase of speed, either by increasing the pace of the treadle, or more usually, by altering the position of the driving band. That less than one inch in diameter, especially during the lighter finishing cuts, may be driven nearly as fast as in turning hardwood. In turning brass and gunmetal, the lathe may be driven at nearly the same pace as for hardwood, subject in like manner to variation of speed according to the diameter of the work. Lead and pewter are driven at about the same speed as softwood.

In surface turning, the driving band is placed at about the medium speed required by the diameter of the work. The

foot lathe may then be made to revolve a little faster or slower, as the tool, travelling at a nearly uniform pace, approaches the center or the margin of the surface; the aim being to arrive at equality of cutting action, by causing the face of the work always to pass the tool at a nearly uniform surface velocity. This, may also be assisted, if the pace at which the tool travels be slightly retarded towards the margin of the work. The speed of lathes driven by power, in which the slow motion is generally obtained by back gearing, is increased or diminished by shifting the driving band upon the steps of the driving pulley and upon those of its countershaft; but the velocity chosen at which the mandrel revolves, is necessarily constant. Therefore to maintain the cut upon the surface at a uniform surface velocity, the pace at which the tool moves has to be decreased, as it travels from the center to the margin, and increased in the reverse direction, readily enough attained by hand, or with the slide rest; while in the larger power lathes, mechanical means are sometimes adopted to ensure this result.

Only a very small shaving or quantity, either in breadth or thickness, is removed from the harder metals by every separate cut of the hand tool; while the cutting traverse of the tool, which may often proceed uninterruptedly along the wood surface or cylinder, occurs to a less extent upon brass, and far less so, in turning iron or steel. Its limited application to these materials only occurs also, when the rough surface has been both reduced and then turned fairly level, by a series of small separate cuts made in close juxtaposition with the appropriate roughing and smoothing tools.

As previously referred to in wood turning, so in turning the metals, it is by no means easy to give definite instructions as to the amount or thickness of material that the tool may safely be permitted to remove at every separate cut. The quantity depends upon many factors; among the more important of which are the hardness and characteristics of the material, the magnitude and form of the work, and the strength and size of the lathe and tool; all or some of which it is apparent, will cause what is reasonable in one case to be excess in another. Excess tears and damages the surfaces produced, frequently

also breaking the edges of the tools; good turning being only attainable, when all the factors referred to, are employed well within their limits of strength. On the other hand, it is possible to observe too great caution in the latter direction, causing unnecessary expenditure of time. Unavoidably upon these points, much must be left to the judgment of the individual, but that may be rapidly matured by experience, for provided the work be securely and correctly chucked, the effects produced upon it and the tool surely indicate whether too severe a cut has been made, or if a deeper may be safely attempted.

The small inequalities, almost inseparable from the most carefully placed separate cuts, even when these have been connected by subsequently traversing the tool, are conveniently corrected, and the metal superficies reduced to one true line, with a file, applied to the work while that is in revolution. The flat file, as will be shown, is of great assistance in finishing cylindrical, surface and other turned works in metal, and its flat face is employed a second time, with fine emery paper wrapped around it, to polish and finish the surface it has previously corrected. The file used in this manner, may then be followed by the further methods of polishing steel, iron and brass, detailed in the Descriptive Catalogue of Apparatus, Materials and Processes for grinding and polishing, Vol. III. The processes for lackering turned and other brass work, for the prevention of subsequent surface tarnish, are also given in the same volume.

The graver and other tools for rough turning wrought iron and steel, require to be constantly supplied with, or to be dipped into water for lubrication, to prevent the metals being torn and to allay the heat set up by the friction in both work and tool. Oil, or sometimes soap and water, are used with the finishing tools and also in cutting screws for the same purpose. Cast iron, brass, gunmetal, and similar alloys, are turned dry; copper, with water, oil, or soap and water. Lead is turned with great facility with the softwood tools, provided they are frequently lubricated with any of the above, milk, or even dirty water; for the purpose of constantly soiling the chemical cleanliness of the turnings and the surface produced. Otherwise, these are liable to partially adhere again to each

other as they are turned, and with so remarkable facility and tenacity, as sometimes to require the use of a cutting tool to separate their accidental adhesion. The turnings from copper, tin, and some others of the metals, adhere in like manner, although to a less degree.

SECTION II.—MANIPULATION OF THE HAND TOOLS UPON
CYLINDRICAL FORMS IN METAL. DIAMOND TOOLS.

The tools for turning iron and steel, whether in long or short handles, are nearly always held underhand, at about the vertical angle of the graver fig. 461. The right hand is grasped around the *short* handle, knuckles uppermost, the wrist and thumb generally in contact with the right chest; the left hand is placed around the shaft of the tool, the knuckles also uppermost, in contact with the right hand, or sometimes partially around the latter and the stem of the tool also.

The weight of the body is always brought to bear, more or less, upon the tool, by leaning the chest upon the clenched right hand around the end of the tool handle; but with greater necessity and therefore more decidedly during the first roughing cuts, that it may then assist in holding the tool with the greatest possible firmness to prevent any endlong motion, to which it is always liable until the work has been reduced to the true circular section. The manner in which the long handled tool is held underhand for turning iron, has already been described in the chapter on softwood turning; and occasional variations in the position of both hands and tools in metal turning, will be referred to.

One corner, the angle formed by the side of the shaft and the bevil to which the graver and other tools are ground for turning iron and steel, is placed on the surface of the tee, into which it slightly penetrates by the resistance in cutting; the thrust of the cut is thus sustained by the rest instead of the hands, which only direct and retain the tool in position. The tee of the rest is placed close to the work, and is much shorter than those used for wood turning, and so far as possible, the tool is placed near to its center or over the stem of the tee, in which position it is most solidly supported and acquires the least vibration; the short tee being shifted along the work

from time to time, that the tool may be always retained upon it at about the same position.

The brass tools are held in several different positions ; the routers figs. 450. 451, and sometimes the square tool, fig. 458, in either long or short handles, when used for strong vigorous cuts, are held after the same manner as the graver in turning iron. For less forcible use, the right hand is placed around the handle of the brass turning tool with the thumb, instead of the knuckles uppermost, the left hand remaining as before ; but the shaft of the tool is then much less underhand. The latter of the two positions is the more general with the finishing tools, figs. 452. 454. and 456 ; while for very light cutting, these tools are held in the horizontal manner, slightly more sloped but otherwise precisely the same as the hardwood tools.

IRON AND STEEL CYLINDRICAL WORK.

In turning the iron, or annealed steel cylinder, the graver rests on the tee by one of the lateral angles of its chamfer, figs 461. 462, the point being placed in contact with the work, with the shaft at a small horizontal angle. In cutting, the portion of the edge close to the point, which displaces the material to be removed, travels in a path combining two distinct movements. It is moved through a small lateral arc upon its supporting corner as on a center ; until at the termination of the stroke, the shaft of the tool arrives at the dotted position fig. 462 ; and it is moved simultaneously through a small vertical arc, by *slightly* rotating the handle from right to left ; until the point, which at the commencement was at about the level of *a*, fig. 463, at the termination of the cut, arrives at about the height of *b*, shown by the second section of the tool.

The graver is moved deliberately, that it may have sufficient time to reduce to concentric truth the entire width of the narrow portion of the work over which it travels, at one operation ; the cut therefore is not deep, and the width, like all cuts made with the graver, varies from about one eighth to about a quarter of an inch, generally lying between the two.

When first applied to the work the graver is placed with its chamfer towards the left, and the first cut is made at the

extreme right hand end of the cylinder. The tool is then shifted along the rest towards the left and a second cut made beside the first, and so on for the length required. Placing the first cut at the end of the cylinder, the corner of which has also been previously thoroughly cleaned by the file or on the grindstone, ensures that the edge of the graver attacks the hard exterior of the cylinder sideways; exaggerated for illustration fig. 462. The second cut being then placed beside the first, the point of the graver enters the clean metal exposed and also reduced to concentric truth by the first, and so on for every succeeding cut; with the effect, that the point, the weakest part of the tool, is greatly preserved from possible fracture by rarely coming into contact with the outer surface

Fig. 461.

Fig. 462.

Fig. 463.

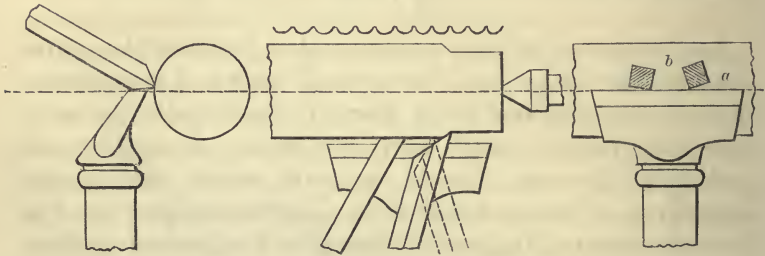

of the work. The triangular tool may be employed on the cylinder in exactly the same manner as the graver and is as efficient, but hardly as strong; the tool is supported upon one corner of its cutting facet.

The first series of roughing cuts with the graver leaves the cylinder concentric, but in a succession of short curves of irregular width, magnified in the line fig. 462. The tops of the ridges are reduced by a second or third series of cuts, the graver being allowed to travel along the work in either direction; after which the line may be corrected by separate cuts, made with one edge of the graver lying on its side, fig. 462, or more conveniently, with the flat tool fig. 444.

The graver is frequently dipped in water which somewhat reduces the friction, nevertheless, the heat set up by the removal of the turnings and in some cases but a small increase

in the temperature of the work, will often expand its length ; elongation taking place still more readily, in long works turned with the slide rest, from the more continuous cutting action. In the foot lathes this effect is at once felt by the increased labor in driving the treadle ; the point of the popit head has then to be slightly withdrawn and refixed, and as the work cools, it may have to be readvanced, so as to maintain a nearly equal amount of pressure. Otherwise in the former case, the work especially when of comparatively small diameter, being bound between the centers, slightly bows and is liable to be turned untrue, while in the latter, the same result may obtain from its insufficient support.

The flat tool for iron is presented to the cylinder at about the same vertical angle as the graver, and usually touches and indents the rest, by the angle formed by its back and cutting bevil ; it is made to cut by being pressed forward and by slightly lowering the handle, or for fine finishing cuts by simple pressure, the tool being usually replaced to make every separate cut. Some prefer to give the flat tool a moderate tilt upon one or other angle of its shaft, to disengage the corners, others, to slightly twist or rotate the tool upon its under corner while cutting ; in either case the tool requires holding with increased firmness, and should the tilt or the twist be in excess or variable, the work is liable to be turned in hollows. A near approach to the cylinder may be obtained by the skilful application of the separate cuts, and as the work approaches completion and there remains but little material to be removed, these may be supplemented by short traverses of the tool ; a higher degree of smooth finish may then be given with the flat file and emery stick.

BRASS AND GUNMETAL CYLINDRICAL WORK.

Work of this character is first roughed concentric by series of separate cuts made with the router, figs. 450. 451. The ridges between the furrows are then reduced by the same tool, and the cylinder is finished with the flat tool, sometimes followed by the file. The roughing tool is supported on the rest with its shaft at about the same angle as the graver fig. 461, the under side of its round cutting edge indenting

the face of the tee. For lighter cutting the under surface of this and the other turning tools for brass, may lie in contact with the edge of the tee, the cutting edge slightly overhanging it. In either position the tool is held very firmly, and the cut is obtained by pressure, or by gently lowering the handle. The irregularities in the line of the brass cylinder left by the roughing tool are reduced with the flat tool, first by separate cuts, a narrow portion at a time, and then by continued traverses of the tool; the tool being held and used much after the same manner as upon hardwood.

The flat and other finishing tools cut very readily upon brass and similar alloys, but their use presents a difficulty incidental to these materials, which are readily set in vibration by the process of turning. The vibration causes the work and the tool to "*chatter*" upon each other, and to leave the cylinder covered by numerous irregular, but parallel, fine lines or striæ, also called "*utters*" by the brass turners; the latter term probably arising from the sound emitted by the work when in vibration against the tool. The formation of striæ is still more frequent in turning the brass surface, and when they are once established upon this or the cylinder, they incite the work to increased vibration, and deepen and spread under the continued use of the turning tool; they can then only be obliterated by returning to the use of the roughing tool, and recommencing the entire process.

To avoid this latter inconvenience, which would probably also unduly diminish the size of the work, the formation of striæ is carefully guarded against from the commencement. A rather narrow flat tool is chosen, and this is first employed to turn the cylinder smooth, only a small portion at a time. The tool is held with considerable firmness, with its shaft presented to the work at a small horizontal angle, so that in making the separate cuts only about *half* the width of the cutting edge penetrates the work. So soon as the line of the work becomes fairly straight, the separate cuts are connected by traversing the tool, during which time it is more liable to "*chatter*"; this may be avoided in some cases, by retaining the edge during its traverse still in the same position, one corner penetrating and the other just free of the work, when either the cutting or the disengaged corner may precede, as the tool

travels along the cylinder. Many brass turners for the same purpose prefer to tilt the flat and other finishing tools upon one corner, and not at one constant angle as in turning hardwood, but continually moving the cutting edge up and down upon the corner on which it rests; so as to constantly vary its angular elevation or tilt, during the entire traverse. The impulses to vibration are then given to the work at slightly, but constantly, varying angles, when their effects cross, and to some extent neutralize each other.

The finishing shavings, which are thinner, may be removed with a wider tool, held also in the horizontal manner; the fingers of both hands close about the end of the tool and upon the rest, the degree of tilt being constantly varied as before. The diminished thickness of the cut sets up less vibration, while the fingers, being more or less *interposed* between the tool and the surface of the rest, act as a spring or cushion, and largely absorb or check the vibrations by associating them with the elastic frame of the operator.

The parallelism of the metal cylinder is ensured by frequently and carefully testing the work done by the tool, by the callipers or some form of gage. With long works, short portions at intervals and towards the two ends, are first turned to the same diameter and measured; the intermediate longer portions of the cylinder are then reduced to the same diameter, under the guidance of a steel straight edge and the callipers. Many long works, it should also be said, require support against the thrust of the tool, by some one of the back stays or guides already described. Fixed gages in place of the callipers, partly as avoiding risk of error from the elasticity of the latter, are very convenient for cylindrical works requiring exact turning to definite diameters. A square notch filed in a piece of sheet steel, similar to fig. 870 Vol. II., is very commonly employed; it is usual to file two notches in the same piece, one of the exact finished size required, the other slightly larger. Carefully bored ring gages are also used for works requiring a higher degree of accuracy.

After the best attainable surface has been produced on the cylinder by the turning tool, a greater degree of smoothness

may be given to it with a flat file, its side made to lie exactly in contact with the revolving work. The guidance of the file largely depends upon the cylindrical correctness of the previous turning; whilst its use requires some care to avoid deteriorating angles or filing the work taper, but these results may be prevented by attentively distributing its strokes equally along the length of the work, and occasional measurement with the callipers or gages.

Most frequently, the handle is held in the right hand and the tip of the file between the thumb and two first fingers of the left, both hands exerting about equal pressure, but holding the file without stiffness to allow its flat surface to take a true bearing upon the revolving cylinder. While to maintain the true bearing without interruption, the file still rests upon the work during the back stroke, during which however, the pressure is almost entirely relieved. The reader is referred to the chapter on files in the second volume, for the correct positions of the operator, and the manipulation observed in delivering the strokes of the file upon a flat surface, most of which it may be said, apply with equal force to the employment of the file upon the revolving cylinder. Upon the more delicate cylindrical works the smaller files may be held in the right hand alone, guided and retained in contact with the work by the forefinger stretched out and resting along them. For the opposite extreme or heavy work, the palm of the left hand is placed on the end of a large flat file, both hands and arms exerting considerable pressure in the forward stroke. The work revolves always towards the operator, or meets the file as that is thrust steadily forward at about right angles to the mandrel; these straight forward strokes being occasionally varied by others, made at a horizontal angle of about 45° ; in order that the individual strokes of the file, may be made occasionally to cross and thereby correct each other's imperfections.

Collars and other surface projections upon the cylinder, are protected from injury by the safe edge of the file being turned towards them. Smooth or finer files are used to follow the coarser; these smoother files are usually slightly oiled, or they may be rendered less active, by rubbing their faces with dry chalk, which partially fills and remains in their teeth; when a

still higher degree of surface smoothness is desirable, a strip of flour emery *paper* is neatly and tightly wrapped around a smooth flat file, which is then again applied to finish or polish the work. The emery paper covered file is shifted from place to place along the work, held square, and then occasionally at small angles to its axis, in order that the abrasions of the emery may cross, and leave less or no decided marks; the covered file is sometimes held quite still, at others it receives a gentle forward movement, but never approaching its previous liberal strokes. It is lifted and shifted forward from time to time, to use a fresh portion of the paper as that previously employed, becomes worn or overcharged with the dust it removes from the work. Moistening the emery paper with oil, improves the quality of the surface but leaves it dull; the latter when cleansed from all trace of the oil is rendered lustrous, by using nearly worn out paper that has received no oil. Less carefully finished turned works in iron and steel, may have their surfaces rendered bright and smooth with the emery stick, prepared in the manner described page 1057 Vol. III.; used after the file, and applied in a similar manner. Those in which mere surface smoothness is sought, as also grooves such as those turned in the edges of wheels, are finished with a strong deal stick and fine grinding emery; the end of the stick is chopped to an edge, and it is applied to the work supported on the rest, the end being from time to time dipped in oil and then in a vessel containing the dry emery powder; precautions being observed in all cases, that no particles of the emery may find their way to the mandrel or other working parts of the lathe.

The numerous cylinders that may be found forming portions of metal work, for machinery, implements, and tools; such as axles, arbors, levers, and pivots, rods, rollers, spindles, up-rights, wheels and others; some of which are indicated by figs. 464 to 476, and offered as examples, that may be wrought by hand turning with the graver and foregoing tools in the foot-lathe; the larger specimens, with greater ease with the fixed tool in the slide rest; the surfaces of many being finished with the flat file.

The various spindles and rods, figs. 464 to 469, or the up-rights, figs. 474. 475 are first set or straightened and centered

in the manner described pages 192—196 ; any difference in their subsequent treatment arises principally from their relative stability, and lies to a great extent in the manner in which they are chucked or driven between centers. One of the carriers can generally be attached to their ends, or sometimes a portion of the work will lie in contact with the driver of the running center chuck, and serve the purpose ; as in turning the shaft of the small crow-bar, fig. 470 ; the tee of the hand rest, fig. 472 ; or the end of the rod, fig. 469 ; which last would be left solid to carry the centers, and be filed open, subsequently to the turning. A portion of the iron hand brace

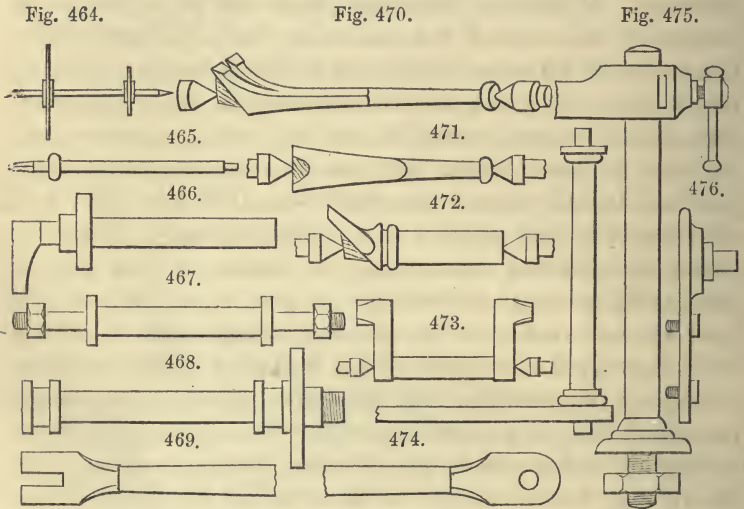

fig. 473, would in like manner lie in contact with the driver of the chuck.

A projection is left on the forging upon such forms as figs. 470. 471. 472, to receive one of the lathe centers, and is cut off or filed away, when the turning has been completed. The ends of spindles are sometimes forged with tails to serve as carriers, fig. 466 ; and the one end of light works, such as the blanks for screws, or the lever, fig. 465, may be left a little longer than required, and filed square to be driven by a square hole chuck ; the portions in excess being afterwards nicked in with the graver, and cut or broken off. The flat plate carrying

a spindle at right angles, fig. 476, would be bolted down upon a surface chuck to turn the cylindrical stem.

DIAMOND TOOLS.

Most cylindrical forms turned in soft steel, when subsequently hardened, more or less lose their axial truth in the process; they are in some cases "hacked" with the hammer, upon portions intentionally left soft, to bring those hardened back to truth, or the latter are ground true with emery, processes described in former volumes. The diamond affords a convenient and somewhat less tedious means of rendering these portions true.

The diamond is used to a limited extent as a hand tool, for turning such works as small hardened steel pivots, but more frequently in the slide rest. The hand tools are made of little fragments, split off from the stone in the first stage of its preparation as a gem, an angle of the fracture containing a portion of the external rind of the stone being preferred for the cutting edge; these pieces called "diamond bort," are inserted in the ends of brass or steel wires after the manner shown figs. 64 and 65 Vol. I., either in their split ends, or more generally in a hole pierced in the direction of the length of the wire. The stone being held by its largest part by pinching in the metal around it, by brazing, or sometimes by melted shell-lac. The tool cuts by the extreme point, and is constantly supplied with water, that neither it nor the work may heat. All the diamond tools produce the best results upon the hardest steel, less so upon portions less hard, and are inefficient upon soft steel, upon which they drag, compressing or burnishing a bright surface marked with occasional lines, rather than cutting. They require a very slow traverse and very slight depth of cut, to avoid risk of breaking the delicate point, and according to its diameter, a comparatively slow revolution of the work, less than half the usual speed for turning steel with the ordinary hand tools. Skilfully used, they may be made to turn absolutely hard steel to a true and perfectly polished surface or cylinder, removing the material in the form of minute turnings; caution however is requisite in the advance of the tool in turning the arris formed by these

two; the intense hardness of both tool and work rendering this angle rather liable to partial fractures. For works of increased dimensions, a similar but larger fragment of the stone is brazed into a stout steel wire which is inserted in the end of a rectangular iron stem for the slide rest, and this enables the tool to be carried quite into an angle in the work; for plain cylinders, the stone is fixed directly in a hole made in the end of the iron stem.

Larger and stronger forms, different varieties of the diamond, which are remarkably permanent, are also employed. The Brazilian "ballas or ball bort" occurs in small quasi-spherical nodules, partially translucent, and also differs from the ordinary diamond in being an aggregation of crystals, possessing a radial instead of the octohedral fracture. Pieces about the size of a pea are placed in the end of an iron stem, brazed in, or the iron punched down around them, care being required in setting by the latter method to avoid cracking the diamond, very little of which is left exposed. Ballas cuts or rather abrades the steel by its rough exterior surface, formed by the ends of the collected crystals; its action is hardly so rapid as that of the previous tools, neither does it leave quite so good a surface, and as with all, it requires a constant supply of water.

"Carbonate," the hardest of the Brazilian diamonds, a non-crystalline substance, opaque, and ranging in colour from dark brown to nearly black, has an amorphous fracture; some specimens contain numerous small irregular cavities, and under the microscope its appearance fairly resembles a piece of coke. Small pieces ranging in size from one to three carats, according to the magnitude of the work, are employed for turning steel, mounted as before in the end of an iron stem, leaving an angle of the fracture slightly projecting. The carbonate although the strongest of the tools, is still most efficient in the ordinary lathe when used like the others, with only a slight depth of cut, usually not exceeding one to two thousandths of an inch, the continued repetition of which gradually reduces the work to truth, leaving it smooth and highly polished. With increased depth of cut, the hardness of the work, its want of truth in revolution and the intense hardness of the tool, combine to exert so great leverage as to bring the latent

elasticity of all parts of the apparatus into play ; the tool continues to cut, but its effects are irregular and unsatisfactory. In more massive lathes the depth of cut may be proportionately increased, provided the work be also of sufficient stability, its effects upon the latter, as in all other turning, unerringly pointing out the extent to which the depth of cut may be safely carried. The material is ordinarily removed as minute particles, reduced copies of those produced by the graver ; but in the course of experiments upon an absolutely hard steel cylinder, $\frac{5}{8}$ ths of an inch diameter, made with a carbonate tool kindly placed at the author's disposal by Mr. J. Ker Gulland, C.E., the angle of the diamond was occasionally found to remove delicate spiral turnings about four inches in length, and but the two thousandth part of an inch in thickness. Which minute, but otherwise precise copies of the long spirals produced in ordinary iron turning in the slide lathe, may be considered as rather remarkable in turning hardened steel.

The carbonate among other purposes, is used in boring rock for tunnelling and well sinking, the drill driven by power, being virtually an enlarged example of that described, fig. 71. Vol. I. ; the stones taking the place of the diamond powder. In the crown drill patented by the above named gentleman, the stones are placed in the ends of short, nearly cylindrical iron studs, which are fixed in holes bored in the annular face of a strong iron ring, arranged at intervals around both edges and over the surface ; the studs being removable, that the same series of diamonds may be employed in rings of differing diameters as required. The largest drill yet made, and also constructed by Mr. Gulland, the Engineer of the Diamond Drill Company, is 23 inches in diameter, carrying fifty six diamonds, and is of the value of £500. This was used in boring to arrive at the green sand, in the deep well for the New River Company at Turnford, 1879 ; and the same diamonds were afterwards transferred to another ring $20\frac{1}{2}$ in. diameter. The latter, working at a depth of 980 feet, and driven from the surface at about fifty revolutions per minute, was found to bore through the gault at the rate of from 12 to 18 inches in the hour ; the water used in the process, at the same time so far washing away the crumbled margins of the hole, as to permit the concurrent sinking of the iron tubes

23 inches diameter, to form the lining of the well. Although comparatively soft, the gault and all other argillaceous formations are found to clog and impede the action of the tool, most of the harder strata being bored more rapidly.

Similar ballas and carbonate tools to those used for steel are largely employed in turning emery wheels and grindstones; water is always required, and with the latter entirely prevents the clouds of dust inevitable in turning grindstones by the usual method. The same tools have lately been successfully employed in turning granite, which material was otherwise incapable of being turned in the lathe. Vol. I. 171. The economy effected over the previous and tedious methods is very considerable, for the author is informed that a carbonate tool has been in constant use for this purpose for more than nine months; this stone has been occasionally reset for security, or to expose a fresh angle, but otherwise it remains quite serviceable. Carbonate, it may be mentioned, was discovered in the diamond gravels of Brazil in 1842, and its extensive use is recent; the valuable properties it possesses are perhaps equally testified by the fact, that so late as thirty years back its market price, now about twelve shillings for the inferior, to twenty five shillings the carat, for the finest quality, was but seven pence; unfortunately carbonate is not extensively met with.

SECTION III.—MANIPULATION OF THE HAND TOOLS UPON SURFACES AND SURFACE FORMS IN METAL.

The steel or iron surface may be turned with the graver and flat tool, employed in much the same manner as on the cylinder, the tee of the rest being placed parallel with the work. Those of small diameter, and collars or shoulders upon cylinders, when reduced to shape by separate cuts of the graver or triangular tool, may then be conveniently turned flat and smooth with the cutting side of the latter. The triangular tool when used for this purpose is held about radially, supported on any one of the angles or cutting edges of the shaft, which indents the tee, and is applied to the work with its side nearly coinciding with the surface to be turned, figs. 477—479. By slightly twisting the handle from right to left, fig. 479,

the upper of its three cutting edges engages in the surface; the vertical angle of the face of the side cutting edge being then nearly that of the chisel upon softwood.

The triangular tool is so effective for turning iron and steel that it is constantly employed upon flanges, collars, and surfaces, such as are found in the illustrations on page 346; it cuts very freely, but is as easily controlled, removing coarse or fine shavings as the vertical inclination of the cutting face, fig. 479, allows the side edge more or less penetration. The variation from coincidence between the work and the face of the triangular tool, may also be diminished or increased during the progress of the cut, by simply varying the twist given to

Fig. 477.

Fig. 478.

Fig. 479.

Fig. 480.

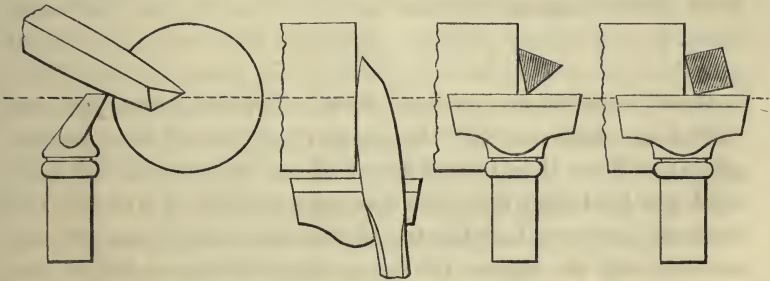

the handle; with the effect, that the metal shaving, analogous to that removed by the softwood chisel, may be made to pass gradually to and from either condition of thickness or thinness, during the process of its removal. Secondly, owing to the slight curve to which the sides of the tool are ground lengthwise, shown on an increased scale fig. 478, a trifling alteration in the horizontal angle at which the shaft is held to the work, will transfer the point of cutting contact to any required spot between the surface and the tool. This permits the cut to be either commenced towards the centre of the surface, and led thence continuously to the margin, or to be carried from the margin in the reverse direction, without the necessity for shifting the position of the shaft of the tool, lengthwise; while it also enables the edge of the tool to be exactly directed upon any particular spot requiring correction.

In practice, the iron surface while in process of turning,

requires frequent testing by means of a steel straight-edge, applied across its center; the narrow surfaces forming the faces of flanges or collars upon cylinders, in like manner are tested by a straight-edge, then, usually one limb of a steel square, the edge of which is held across them; the rectangle of the square, also determining the correctness of the angle the surface forms with the cylinder. The surface may be continued quite into the internal corner, by the longest or most pointed cutting side edge of the tool, fig. 443; only the extreme point of the triangular tool then arrives at the cylinder, and need not cut into it, nor other finished portions of the work. The corner is completed by finishing its portion of the surface, and the abutting end of the cylinder, concurrently; the tools appropriate to either, being exchanged from time to time as required.

Brass surfaces are reduced, first by separate cuts with the router or sometimes with the graver, but ground to a suitable angle; and are then turned true and smooth with the flat tool, used and held after the same manner as on the cylinder. The tools are supported on the tee of the rest, placed close to and parallel with the surface for the heavier cutting, and upon the arm rest, as in hardwood turning, with the tee parallel with the mandrel, for lighter works and for finishing.

Small surfaces, edges and collars, may be turned with the point tool held underhand, a narrow portion at a time from the margin towards the center; the edge is placed in contact with the surface, the back of the tool lying flat on the rest, and it is made to cut by tilting the tool towards the work, and by pressure. The square tool fig. 458, is also largely used for turning and finishing brass surfaces of small size, flanges and edges, and upon the armrest, for internal work; it is held a little underhand and is otherwise employed, fig. 480, in exactly the same manner as the triangular tool for iron; which tool it closely resembles in all particulars save that of section. Both tools are thoroughly efficient, but *only*, when each is employed upon the respective materials to which their cutting angles are suitable.

Brass and gunmetal surfaces, more especially those that are

thin in proportion to their diameter, are far more liable to the formation of striæ than the cylinder; the same precautions already explained, have to be more carefully observed for their prevention. The flat tool is held with great firmness, whether supported on the tee or the armrest, the tool and the hands as in the horizontal manner, with only a narrow portion of the cutting edge in contact with the surface. The cutting edge is not allowed to remain more than a moment strictly quiet at the same elevation during its traverse, and the one end is frequently allowed the most penetration, just sufficient for the opposite end to escape cutting. The finishing tools are also barely allowed to touch the surface of the tee, by the partial interposition of the thumb and forefinger upon either side, the fingers, rather than the tool being pressed on the tee. The armrest, used precisely as in hardwood turning, the end of the tool surrounded and supported by the fingers of both hands is still more efficacious in aiding the absorption of vibration, and is constantly used by the brass turners for surface and internal turning. The vibration of thin surface works, may also be considerably reduced by judicious chucking; when the thin plate becomes to some extent incorporated with the more solid surface chuck, to which it is attached by clamps, screws, or cement, as already described.

The finished turned surface in iron or brass serves as a guide to the flat file, when that is used to obtain increased smoothness;—the safe edge being turned towards any cylindrical portion;—and the file, held in the right hand, is retained in contact with the surface by the ends of all four fingers of the left hand pressed upon its flat side. The contact of the smaller files upon light work, is sufficiently ensured by the forefinger of the right hand which holds the handle, being stretched out along their sides. The stroke of the file is always a tangent to the circle it covers on the surface, but the vertical inclination at which its strokes are given, is frequently varied to cause the different strokes to cross and correct each other's work; the object and necessity for which, have been already referred to in the second volume.

SECTION IV.—METAL CONES, CYLINDRICAL AND SURFACE CURVES.

The cone and conical shapes in metal, are used for centers of motion, for fittings, and sometimes only as the line to connect two different diameters in the same solid, when it is desirable to avoid a break, or shoulder. The manipulation of the tools hardly differs from that for the cylinder, but the rest is usually placed nearly parallel with the side of the work.

Lathe and other centers, fig. 481, and the pointed ends of spindles, are turned to shape with a small reversed cone at their apex, for their support by the point of the popit head. This little cone is then broken off, and the work is supported

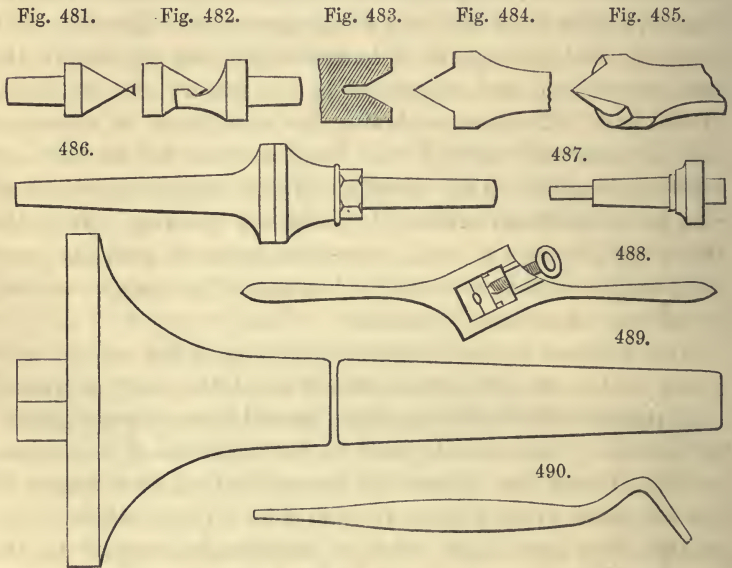

by a hollow center of the same angle, fig. 482; the hollow center is filed down to the diametrical line, and curved away, so as to expose the apex of the solid cone; the point of which is finished by a flat file, guided by lying in contact with the portion previously completed. The corresponding hollow center is commenced by a small cylindrical hole, bored a little deeper than the depth of the required cone, as in the section, fig. 483; the aperture is then turned out to shape with the graver, followed by the triangular, or point tool, sometimes

with the assistance of a template, and is finished with a conical bit. The conical boring bit, shown in two views, figs. 484. 485, is filed down to the diametrical line to form the cutting edge, and is provided at the reverse end of its shaft with a center for the point of the popit head. This bit does very little cutting, being principally required to correct the small inaccuracies left by the turning tool. The use and construction of conical fittings or bearings, of which the lathe mandrel is a conspicuous example, have already been described. The external truncated cone, is perhaps most usually turned first, and the corresponding hollow cone turned out or enlarged to it. The two are then fitted to the necessary degree of accuracy, by the different methods described at length in the third volume. The very slightly tapering cones, often required in fittings of small diameter, are usually bored cylindrical and then opened taper by a broach; particulars of the varieties of this tool, and of the boring bits, have been given in the second volume.

The conical line very frequently merges into the hollow curve, as in the saw spindle, fig. 486, and in previous examples. Such curved forms in iron or brass are first shaped by separate narrow cuts, with the roughing tools appropriate to the material, and are then reduced to a regular line and turned smooth with the round tools, used to a great extent also in separate cuts, followed by the file and emery stick. The shaft of the round tool is applied radially to the curve, fig. 438, but the tool also obtains some rotation on the center of its own curvature, besides some lateral traverse for the finer and finishing cuts. The junction of the curve with the straight line is turned with a flat tool, and requires a little care to avoid forming an elbow by turning the one to dip below the other; this does not readily happen unless intended with convex terminal curves, as in the taper handles of the diestock, fig. 488. These are turned to shape with the graver and then smooth, with that, or with a flat tool, presented and traversed radially around the curve.

The handles of the diestock, and the round steel lever, fig. 490, are common examples of long flat curves in the direction of the cylinder, turned by hand; the end of the lever is bent to shape after the form of the rod has been completed.

The lever post of an ornamental slide rest, fig. 487, affords a small example that combines cylindrical, taper, and curved portions. Many similar small hollows to the last, used for ornament, are obtained by the application of an appropriate sized round tool, or which is preferable, by using one rather less than their width, that the tool may receive a slight rotation upon its cutting edge to equalize the curve. The tools, except for the different vertical angle at which they are presented to the work, are employed on brass or iron much as in turning a similar curve in hardwood. Narrow convex curves in iron or steel, the reverse of the last, such as the edge of a washer, or a bead in a moulding, after they have been reduced nearly to shape with the graver, may be finished with the flat tool for steel, fig. 444, held almost like the softwood chisel, in the reversed position shown and described page 524, in the second volume. Convex edges in brass or gunmetal, when reduced to shape, are finished with the flat and round tools, swept around them as in turning hardwood, the tool supported on the rest; for similar curves on the surface or upon the edges of apertures, the tools are more conveniently applied upon the armrest.

Rounded forms, and edges in steel, iron and brass, are frequently burnished, the effect of which process is to compress the particles on the surface, rendering the work lustrous with a high degree of polish. The burnisher is of hardened steel, generally from five to seven inches long, tapering in form and of a flat oval section and handled; those of oblong section, half round and round, used in clock and watchmaking and some others, are mentioned page 1042. Vol. III. The burnishers themselves are highly polished, and for successful results, require to be kept perfectly clean, in good condition and free from rust.

Work of iron or steel having been turned or filed to shape, has the file marks first removed with emery paper, or with a fine emery stick and oil. It is then wiped clean and examined, to observe whether all scratches have disappeared, and also that no particle of emery has become embedded in its surface; after which a finer grain is given to it with a worn emery

stick, one upon which the emery has become finely pulverized and has nearly disappeared from use. Again wiped thoroughly clean, the work is then further polished with crocus powder, applied on a stick covered with a strip of buff leather.

When the work is held in the vice during the burnishing, the burnisher is held by the tip between the finger and thumb of the left hand, which as a fulcrum rests quiescent on the vice chop, and its edge is forcibly rubbed backwards and forwards over a small space, by the right hand holding the handle. A rather considerable pressure is given, but as the round edge of the tool, the portion principally used, meets and acts only upon an exceedingly narrow line upon the rounded surface of the work, no more than is necessary should be employed; neither should the burnishing be continued on any spot, for a time longer than the few strokes which suffice to produce the effect, after which the friction is deleterious. The contact is then made to fall on the right and on the left of the first line, in which manner a narrow space not exceeding about half an inch in length may be gradually completed. The hands are then slightly shifted, to burnish similar portions lying on either side and merging into the first, until the width is attained, after which the work is shifted round in the vice, and the operation repeated on fresh portions joining the first. With works burnished in revolution, the left hand is placed on the tee of the hand rest, which is fixed close to the work. The pressure as before is given by the right hand, the contact of the edge of the burnisher being gradually and slowly continued all over the space under operation, commencing about the center of the width, and proceeding to its margins, first in the one direction and then in the other; the entire width being thus completed as a series of narrow circular lines in juxtaposition, merging into each other.

To prevent abrasion, the work and the rounded edge of the burnisher are plentifully moistened with clean oil, which soon becomes blackened by the friction; they are both also frequently wiped with clean rag to remove the used oil, and, as a precaution against the possible intrusion of a particle of the metal or other extraneous substance between the two, which would leave scratches. The burnisher is also rubbed from time to time on the buff stick, to keep it clean and in con-

dition, being always again wiped clean and oiled, before it is returned to the work. Usually, the work is entirely burnished over a second time, but with less pressure and oil; some then prefer to moisten the burnisher with the tongue.

The surfaces of brass and gunmetal work are finished with rotten stone and oil in place of crocus; and then with washed whiting (see Vol. III. page 1101), applied dry with the buff stick; the process is otherwise the same, except that far less pressure is required, and the burnisher is moistened with water with or without the addition of a little vinegar.

The cast iron trumpet mould, fig. 489, is one of the larger examples of curves in metal, that are necessarily turned by hand. The moulds for the bell of the instrument vary from about three to eighteen inches in diameter at the base, and are from about six to eighteen inches in height; they are provided with a square projection at the lower end, to be held in the vice or inserted in a hole in the work bench. The conical brass or silver tube for the bell of the horn is gradually and equally beaten out, with round faced hammers and wooden mallets, upon a succession of moulds gradually increasing in size; the thin edge being finally turned over and strengthened by enclosing a wire ring. The prolongation of the bell into the taper tube of the horn, the two parts being soldered together, is beaten upon taper or curved triblets of appropriate sizes; the angles at the end of the mould and those of the triblet being slightly rounded, that they may not indent the tube. The various curves for the moulds for different instruments, also vary somewhat with the views of different makers, but their exact and regular curvature is essential. The mould is first turned, most conveniently with the heel tool, figs. 415-17 Vol. II., to the shape of a wooden template, which is frequently applied to the work its edge smeared with powdered red chalk mixed with oil, to mark the high points of the curve that require reduction. It is then turned a second time and very exactly, with the heel tool and ordinary round tools, to the gage of a thin sheet metal template accurately filed to the shape of the curve. Subsequently to this, the entire surface is carefully filed smooth with a crossing file, applied without

rotation of the work, removing all marks of the turning tool ; after which the mould is finally polished.

The tubes of the more exactly constructed silver flutes are drawn upon steel triblets, which may be cited as difficult specimens of hand turning. The sides of some of these taper triblets are formed as very long, flat curves, often varying but a few thousandths of an inch from the straight line ; in some extreme cases, the curve rising to no greater extent than one single thousandth of an inch in the diameter, its rise and return extending over half an inch in length. The exact proportions of so slight a curve, and the exact length it covers in gradually merging again into the straight or other line, require

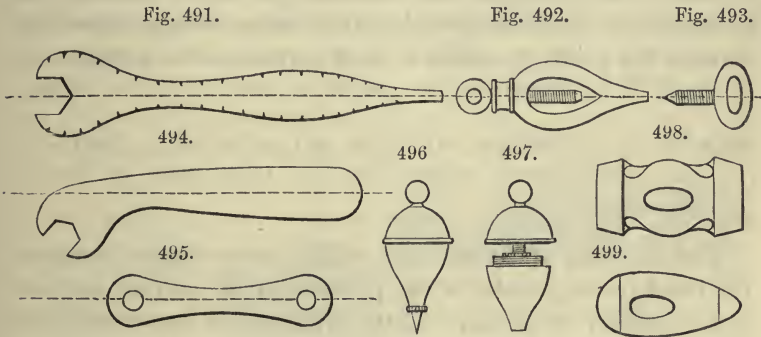

the most minute attention in turning and finishing the triblet, and are stated to materially affect the tone of the instrument.

The turning tool is employed to obtain similarity of shape, in the two curved sides of various forms, having flat and other sections. The key fig. 491, which serves as its own carrier, is mounted between centers, and the graver held very firmly underhand is cautiously advanced to turn a series of nicks at short distances all along its contour ; these equally indenting the edges, serve as the guide in subsequently filing the two sides alike, during which process the work is held in the vice. The small round end used as a lever, is turned taper after the edges have been marked out with the graver. The forms of many such objects, in which the sides are required alike, and true with other turned portions, of which the frame of the diestock, fig. 488, the carrier, fig. 492, and the oval heads of thumbscrews are instances, are usually shaped in this manner.

The curved faces and contiguous portions of many hammer heads and other tools, are also turned; while some, such as fig. 499, a steel crushing hammer, an ellipsoid modified in shape from the tooth of the hyæna, and used by geologists, are turned all over the entire surface. When the pane of the hammer does not lie across the axis of the head, the center to turn the face, is afforded by an L shaped piece of metal, after the method fig. 228; the shorter limb is placed through the eye, and the longer, the end of which carries the center, is gripped together with the pane in the carrier. The brass plumb-bob, figs. 496. 497, is of double curvature, and is shaped with flat and round tools, applied radially around its curves; it presents no peculiarity as a specimen of metal turning, but is noteworthy from being made in two halves which unscrew to contain the point, to enable it to be carried in the pocket.

SECTION V.—INTERNAL CYLINDER AND SURFACE. SEQUENCE,
OR CONSECUTIVE CHARACTER OF PROCESSES IN METAL
TURNING.

The hardness of the material rather closely limits the use of the hand turning tools, in the production of internal surfaces and cylinders in metal. Little difficulty is experienced in turning recesses, shallow compared with their diameter; but as the depth increases, the tool so soon overhangs the support as to unduly diminish the leverage available for its direction, when it becomes unmanageable. A small square or straight-edge, and the inside callipers, may be employed to test the truth of the work done, but it is obvious that the work must be executed with increased care as to results, as the file can no longer be used to correct or assimilate the separate cuts of the turning tool.

Shallow recesses may be turned or sunk in iron or steel, by the reduction of the external surface; or with greater convenience, if the work have been first forged or cast hollow, when the interior surfaces only require to be turned clean and smooth; the tools in either case, except that their stems are held more or less parallel with the mandrel axis, being used in the same manner as for external turning. The narrow tee whenever possible, is advanced within the aperture as the work

progresses, and placed close to the internal surface, in which case the graver and flat tool may be often nearly as well supported as in external turning.

The shallow internal cylinder, or edge abutting upon the internal surface, in iron, is turned with the edge of the graver or with the side of the triangular tool. The tee of the rest is usually placed across the mouth of the aperture, but one end can sometimes be placed within it, when the tool may be supported close to the work at increased depth. Similar recesses in brass, are produced with more facility, and may be turned relatively deeper. The router, flat, and round tools, for flat, or concave internal surfaces, and the square or right side tools, for internal edges, being most conveniently and more generally applied to the work upon the armrest. Apertures of the opposite character of small diameter compared with their depth, in either iron or brass, are produced by drilling, or,

Fig. 500.

Fig. 501.

Fig. 502.

Fig. 503.

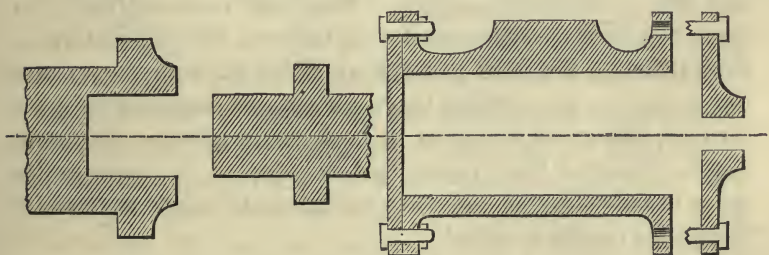

they are originated with the drill and enlarged by the broach or rimer, by turning or by other means; which methods, with the drills and tools employed, having been fully referred to in preceding volumes, it is not proposed to enter upon their description in this place.

The internal surface, terminating the deep internal cylinder in the socket, fig. 500, could not be easily turned flat by the hand turning tool. In such a form the difficulty would be evaded, the aperture being bored or turned, to a depth rather more than sufficient for the length of the corresponding piece, fig. 501. The cylindrical portions of both, the external face of the socket and that of the collar upon the pin, all easily accessible, would be carefully turned true and flat to ensure

the bearing and the two pieces being in the same axis ; when any small irregularities in the internal surface become unimportant. When it is essential that the internal surface should be accurately flat, as in fig. 502, it is more usually formed as an external surface on a separate piece, to be attached to the end of the internal cylinder, that has been turned or bored out by a cutter or boring bar, one of the varieties described pages 569—572 Vol. II.; the two parts being then attached by bolts or otherwise.

SEQUENCE.

Plain turning of every kind requires to be followed out from the very commencement upon some plan or system, to secure the concentric truth of all the component surfaces of every individual portion of the work ; a condition which also ensures the relative truth to each other of these different portions, when fitted or placed together as a whole. The precautions taken to attain these results vary in degree with the work, as that may be of an ordinary character, or requiring considerable and also permanent accuracy. They also necessarily vary in cautiousness of procedure and completeness, with the materials. For, although the same general principles guide the mode and the sequence, upon which the work may be executed in wood turning, numerous examples of both being given in following pages, whatever the system that is adopted, it requires far more exactitude and elaborate execution to arrive at equally successful results in metal.

It is necessary, first to consider the most advisable succession of steps to be adopted in the turning, and then to devise the most exact methods for the requisite successive chuckings ; in which latter, lie the majority of the precautions taken for attaining final truth in the work. Unfortunately the most advisable method of chucking, cannot be invariably followed, it is therefore frequently necessary to modify the proposed method, which would otherwise be preferable, to adapt it to the means that happen to be available. The brass pulley of the mandrel of the foot lathe, fig. 113. requires exact and permanent truth, not alone for driving the mandrel, but also because its face is drilled with holes to form an accurate division plate, while various other apparatus is frequently attached to its back face, and therefore depends for its permanent

accuracy of position upon the enduring truth of the pulley. The lathe pulley also affords a somewhat comprehensive example of the successive steps that may be necessary in chucking and turning in metal; the numerous processes required may therefore be consecutively and briefly referred to.

The pulley is composed of two brass castings shown in section, one the back, a hollow cone, fig. 504, formed externally in square steps, and the other, the front plate and socket or tube, fig. 505; these having been "burred" or cleansed from the sand and hammered as usual, the pulley is constructed in the following stages.

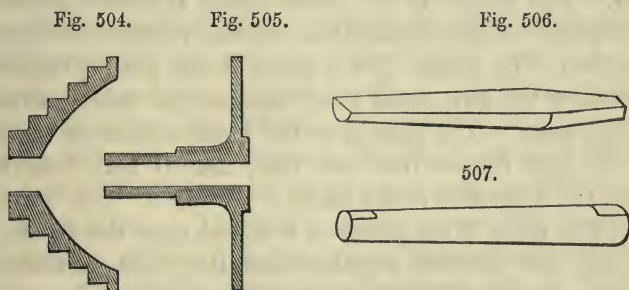

(a) The front is chucked in the universal or other chuck, held externally by the end of the socket, the left hand end in fig. 505; taking care that the plate runs true laterally. The central hole to receive the mandrel is bored, and the work being removed from the chuck, the hole is broached out to size, with the slightly taper **D** broach, fig. 506.

(b) A conical steel arbor, fig. 507, which may be considered for the time to represent the mandrel, is prepared, turned to size and true to its hollow centers at either end; and the socket just broached is fitted upon it; the inner side of the plate, and the exterior of the socket, are then rough turned true.

(c) The back of the pulley fig. 504, is chucked in the universal or other chuck, held externally by its smallest step, the casting being adjusted to run as true as possible, and the inside of the cone is rough turned true.

(d) The central hole at the back of the pulley, is bored out to a diameter of about one quarter of an inch less, than the external diameter of the end of the socket of the front casting;

and this hole is cut with an internal screw, suitable for the reception of the socket. The work remaining in the same chucking, the narrow front surface of the shell, fig. 504, is turned true and flat, in order that it may bear fairly against the front plate when that comes against it. The chuck is removed, but the back of the pulley is left in it undisturbed, to provide for the contingency of any alteration being required, either to the face or the internal screw.

(e) The front portion of the pulley on its arbor, is again mounted between the lathe centers, placed the reverse way to fig. 505, and an external screw is cut upon the end of the socket. The length of the screw being sufficient to prevent the shoulder at the termination of the thread, coming into contact with the inside of the back of the pulley, before the front face of fig. 504, bears firmly against the inner surface of the front plate. The margin of the inner surface of the front plate, is also turned true and flat; that it may bear fairly against the front face of the back.

(f) The front of the pulley is removed from the arbor; the two parts are screwed together and the joint carefully examined, to ascertain whether the two surfaces thoroughly fit each other around the entire external circumference of the pulley. If it be necessary, both surfaces are corrected until they do so.

(g) The two faces of the back and front of the pulley to be united, and also the external screw on the socket, but not the internal screw, are then tinned; and the two halves of the pulley are soldered to one another with soft solder, being drawn together into close contact by the screw on the socket. For this operation, the two portions of the pulley are heated on an iron plate over a fire, or preferably, because more equally, over a gas stove; the processes followed in tinning and soldering, will be found in the first volume.

(h) The arbor is replaced in the complete pulley and mounted between centers, with the face of the pulley towards the lathe head; the back surface of the pulley and the square steps, are then rough turned true. The arbor is then reversed upon its centers and the front face of the pulley rough turned; the surface of the central boss, being carefully turned true and finished.

(i) The arbor is removed from the pulley, and the mandrel for which the latter is intended is mounted between the lathe centers, and turned to the exact taper required; to precisely fit the conical hole in the pulley. The shoulder, left on the mandrel, fitting against the surface of the central boss.

(j) The pulley is replaced upon the arbor for the last time, and its angular grooves rough turned in the square steps; a strong point tool is employed, which, after it has made some little penetration, is applied against either side of the grooves alternately.

(k) The arbor is removed, and a brass plug, about one inch in length, is turned and carefully fitted into the front end of the central conical hole in the pulley; the flat top of the plug being level with the surface of the central boss. A center mark is struck with a center punch, at any position *on* the line of contact of the central hole and the plug; at which center, a hole is bored about one eighth of an inch diameter, and about three quarters of an inch in depth, parallel with the axis of the pulley. The hole is therefore one half in the brass plug and the other half in the edge of the conical hole in the pulley. The plug is removed, and the half hole in the pulley is converted into a rectangular keyway, by means of a steel drift, aided when necessary by a chisel, or square files; all burr caused by cutting the keyway being subsequently carefully removed. The key way receives the steady pin, used to prevent the pulley from moving upon the mandrel.

(l) A circular line is struck around the mandrel, about one quarter of an inch from its shoulder, and the circumference of this line is divided into two halves by the division plate, and scribed across with two short lines. The intersections are then marked with centers by the center punch, for the points of the drill and popit head; and a shallow transverse hole of about one quarter of an inch diameter, and about one eighth in depth, is bored in the mandrel to receive the steady pin.

(m) The steel steady pin, is turned to tightly fit both the depth and diameter of the hole bored in the side of the mandrel; and its projecting end is filed with two flats on opposite sides, until it is reduced to accurately and tightly fit the square key way, previously cut in the pulley.

(n) The steady pin being inserted in its place, the pulley is

again mounted upon its mandrel, and is brought up into contact with the shoulder on the latter, by the screw and nut on the mandrel behind. Being thus fixed as it will revolve when in use, the mandrel is placed between the lathe centers, with the front of the pulley to the left, or towards the lathe head. A strong point tool, firmly held in the horizontal manner, with the fingers placed as near as possible to the end of the tool, is then used to finish the grooves to size and accurately true; but, the tool is only applied to turn the right hand side of every individual groove.

(o) The position of the mandrel and pulley between the centers is reversed, that the opposite sides of the grooves, which are now to the right, may also be finished with the point tool. The opposite sides of the grooves, are thus turned alike and to the same angle, while occupying the same position with respect to the light; necessary to avoid any difference arising from optical illusion, which interferes with their being turned precisely alike, when they are not thus placed in the same direction.

(p) The mandrel is reversed, the bead or edge of the pulley, the back surface, and the shoulders of the grooves are accurately turned and finished with a flat tool; firmly held, with the fingers closely around the end of the tool to prevent vibration.

(q) The mandrel is once more and finally reversed, that the face of the pulley may be turned and finished flat with the flat tool; the edge of the central boss is finished, and the hollow at the corner turned with a round tool. This concludes the turning, leaving the lathe pulley ready for drilling the circles of holes to form the division plate, prior to engraving the figures and numbering, and the polishing.

CHAPTER X.

SCREW CUTTING.

SECTION I.—INTRODUCTION. STRIKING AND CHASING SCREWS
WITH THE HAND TOOLS.

THE screws cut upon hardwood, ivory and metal, for the direct attachment of one portion of work to another, which also greatly vary in their diameters and other dimensions, in many cases from choice or necessity, are cut or chased with screw tools in the plain lathe by the unassisted hand. The traversing mandrel, fig. 112, renders the operation of screw cutting mechanical and certain of success; the same screw tools are used in the hand, or the tool is applied to the work in the slide rest. Metal screws for bolts and ordinary purposes, previously cut or marked out by the diestocks, frequently have the principal portion of the material removed in the lathe also with the hand screw tools. Accurate and long metal screws are cut in the slide lathe, or by the apparatus connecting the mandrel with the slide rest screw, generally known as the spiral apparatus. Soft wood screws are cut with the traversing mandrel, or with the screw box. A description of the last tool is given in the second volume, to which the reader is also referred for particulars of the different varieties of screws, the methods by which they have been originated, and the various tools required for their production; the present chapter deals with the manipulation of the tools and apparatus above referred to.

The cutting edges of the inside and outside angular threaded hand screw tools, figs. 404. 405, are composed of a series of equidistant points, exact counterparts of the form or angle of the thread they are intended to reproduce. The angle on the face of the points, giving the depth of the thread, usually varies from about 45° to 60° , and for some purposes to 90° ; in accordance with the material to be cut, and also in a minor degree with the dimensions and purpose of the screw. Screw

threads of the deepest angles are probably to be found among those cut in steel, followed consecutively by shallower in wrought iron, gun-metal and brass; cast iron, in which the threads are liable to crumble, and are more usually tapped, requires still shallower threads; and lastly, thin brass tubes for optical and other instruments have very shallow threads, to avoid cutting too deeply into the substance of the work. Very deep threads in wood, are apt to break away at their edges, while the very shallow, are unsuitable to a material to some extent elastic and not generally allowing very exact fitting. The range of depth in screw threads therefore, may be considered as the least in wood, rather more in ivory, but the greatest in metal.

The angular teeth of the screw tools are cut upon hobs, fig. 551. Vol. II., tools made as short portions of angular threaded steel screws, grooved longitudinally to form cutting edges and hardened. The steel blank or shaft of the tool after being thoroughly annealed, is pressed against the revolving hob, the screw thread upon which penetrates the edge and causes the blank to travel along it. Arrived at the end, the blank is withdrawn and replaced at the commencement, the traverses being repeated until the blank is cut to the interval and form of the thread, as seen in the teeth on its face, and to their vertical angle or rake, as seen upon its end. In cutting large screw tools of coarse threads, the hob is usually economized by removing the bulk of the material with a file after the tool has been marked out upon the hob. The marks made upon the edge are deepened with a crossing or with a triangular file, until the teeth are tolerably well developed, the tool is then returned to the hob for completion. The screw tool in either case thus exactly fits the thread of the screw or hob; it exactly reproduces this thread, but also cuts it upon screws of larger or smaller diameter than that of the hob.

The tool formed by travelling along the hob, in turn is traversed along the cylinder to cut that into a screw, and the cutting action of the hand screw tool may be thus described. Every complete revolution of the hob in cutting the teeth in the screw tool, carries the tool to the left, a distance equal to the interval between two of its threads; and in cutting the screw upon the work, the tool in like manner for every

complete revolution of the work, requires to be traversed along the rest towards the left, an exactly similar distance. If the first point alone of the screw tool be supposed to commence the screw, at the end of one revolution of the work, it will have travelled sufficiently to the left, to allow the second point to arrive exactly at the spot where the first began to cut. At the second revolution the third point, and at the third the fourth point, will have arrived at the same spot and so on, the first, second, and third points, passing on up the cylinder in regular progression, each continuing in the one and the same screw path just travelled by its predecessors. On the other hand, should the traverse of the tool be either too rapid or too slow for the interval between its points, these cannot take up each other's action, but falling instead somewhere between, produce a break or bend in every coil of the screw, or else a regular or irregular double thread, as the degree of error in the traverse may be large or small. The exact or sufficient traverse is most necessary at the moment the tool first touches the work, called that of "*striking*" the thread, that the teeth may at once impart their exact vertical angle or rake; the first short helical cut thus once correctly made, becomes the guide and gives the path to the teeth of the screw tool, to continue the screw in length, and to "*chase*" the form of its thread.

Uniformity in pace is essential; but the rate of the traverse varies with the coarseness or fineness of the particular screw tool in use. The coarse screw tool from the greater interval of its teeth, has to traverse a greater distance during every one revolution of the work; and therefore according to their relative difference, travels more rapidly than the fine. The diameter of the work also exerts some influence upon the rate of any particular tool, in as much as the lathe may revolve more rapidly with work of small, than with that of large diameter; the traverse of the screw tool is slightly accelerated on account of the increased speed of the mandrel, but the distance the tool is shifted is still the same, relatively to every revolution of the work. The traverse necessary for different threads, and the very slight modifications of speed required upon different diameters cut with the same tool, are readily appreciated with moderate practice; which it must also be said, is the only

mode of acquiring the habit of striking and cutting screws with the hand screw tools.

STRIKING AND CHASING SCREWS WITH THE HAND TOOLS.

Screw tools intermediate between the extremes of coarse and fine, such as numbers 4 or 5 of the table page 673. Vol. II., are the most convenient for elementary practice ; their points are sufficiently large to be readily observed in replacing them in the thread, but they do not require so quick nor so bold a traverse as the coarser screw tools, and, they cut a screw that is a very generally useful size for wood or ivory. The first attempts may be made on a piece of boxwood, about an inch and a half in diameter, driven into a plain chuck, turned fairly cylindrical, the end concentric, and the corner rounded or bevelled off, figs. 508. 509 ; failures and successes being turned away with the flat tool to continue the practice

Fig. 508.

Fig. 509.

Fig. 510. Fig. 511.

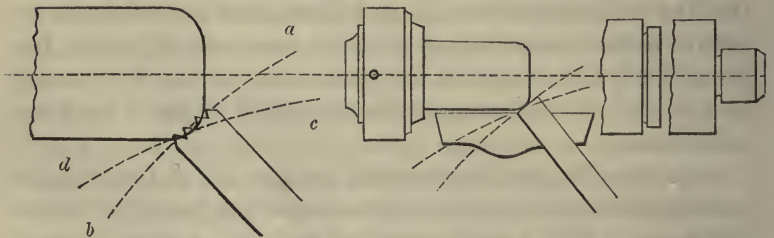

upon different diameters. Further practice may then be pursued upon wood, ivory, and metal, using tools for both coarser and finer threads.

The outside screw tool is held in the horizontal manner, already described, with the rest placed parallel with and about the eighth of an inch from the work, and sufficiently high for the face of the tool, which slopes slightly downwards, to be about radial. At the moment of striking the thread, fig. 508, the tool itself hardly touches the rest, but is supported just clear of its surface, held between the sides of the left thumb and right forefinger, the thumb and finger being pressed on the rest ; in subsequently chasing the screw, and continuing the

thread along the cylinder, the back of the tool lies flat and in contact with the surface of the rest, except when cutting screws of coarse threads on comparatively small diameters, when the tool sometimes requires a slight tilt upon its left under corner.

In making the first stroke, the serrated edge of the tool follows the curved line *a b* fig. 508, being guided by the action of both wrists, the right bending forward advancing the tool, the left backward and rather upward, to allow the left thumb to yield before it and control its pace; the tool thus moved by the right wrist as on a center, also simultaneously receives a slight upward and nearly parallel traverse of its entire shaft, given by the movement of both hands with the tool, in the direction from *a* to *b*. This first stroke takes effect about the center of the curve, so that the *depth* of the one or two turns of the short helical line produced, gradually diminishes towards both ends. The tool is then re-applied with a similar stroke from *c* to *d*, or a little more nearly in the line of the cylinder; the second stroke being a copy of the first in manner and rate, the teeth dropping into the helical grooves made by the first, which considerably assist and guide the second traverse of the tool in prolonging the thread towards the cylinder. A third stroke with the edge of the tool more nearly parallel, leads the screw on to the cylinder, along which it is continued by subsequent short strokes, the tool traversed in a straight line.

The screw line when accurately struck, appears when in revolution to flow steadily from right to left; but, should the tool have been moved either a little too fast or too slowly, there will be a visible bend or break in every coil; the screw is then said to be "*drunk*," and in such case instead of their steady regular motion, every coil as it revolves appears to waver from side to side. When slight this fault may be to some extent corrected, by the subsequent chasing or traverses of the tool, so as to form a passable screw; usually it is beyond correction, the work is then reduced with a flat tool and the stroke re-attempted.

The manipulation in striking the external screw is as follows. The lathe is set in gentle revolution, and the tool is

made once or twice to traverse the path *a b* just out of contact with the work, that the hands and eye may judge, and become accustomed to the path and rate of the tool, before making the actual stroke. The stroke is then made deliberately, without hesitation, and is commenced in *unison* with the first moment of the descent of the treadle, that, when the foot gives it impulse. The tool, which is made to cut by the teeth about the middle of its edge, is allowed but little penetration, not to interfere with its exact and correct traverse, when each point follows precisely in the groove made by its predecessor.

The second stroke is far easier, being aided by the revolution of the screw line made by the first, this is watched while the preparatory trial motions are made for the second, that the points may be guided exactly into the grooves made by the first. Sometimes, especially with deep coarse threads, both first and second strokes require exact repetition to deepen them, before proceeding further. In the second and succeeding strokes the tool is only moderately pressed against the work, that it may deepen the former grooves, and at the same time by their revolution, be carried forward and increase their length. The further traverses of the tool in chasing the screw on to and along the cylinder, are guided entirely by the nascent screw line, each short stroke deepening the termination of the last, carrying the screw on a little further, to be itself taken up and continued by the next. There is very little difficulty in "catching" the thread, that is in dropping the points of the tool precisely into the existing grooves, but, should they alight anywhere between, they damage the thread or perhaps establish a second that cuts into and destroys the first. Vigilance of eye, a sense of time and that of touch, acquired after a little practice, prevent this accident, especially if the tool be always replaced and the stroke commenced at the first moment of the descent of the treadle. The depth of cut allowed the tool, may be varied by pressure or by lowering the handle, in precisely the same manner as if the tool had a plain instead of a serrated edge. The latter force or leverage, is but sparingly used, and principally at the moment of striking the thread; the pressure is always comparatively light, not to interfere with the action of the thread in carrying the tool forward in

chasing the screw. The thread being completed in length, the screw may prove taper, or its diameter be too large for its purpose, so as to require reduction. This cannot be effected by chasing alone, for the thread completely filling the angular notches in the tool, is damaged or crumbles away from the friction, if its further use be then attempted. The screw is reduced in diameter or turned cylindrical with a flat tool, which removes the top of the threads, but still leaves a sufficient screw line to guide the path of the screw tool in re-cutting and finishing the thread.

For practical purposes, the hardwood or ivory external screw of large or small diameter, is first turned cylindrical, somewhat larger than the size to which it is required to be finished, and its shoulder to a surface, figs. 510. 511; the front corner is turned to a small bevil, or if the screw be short, just sufficiently rounded to destroy the arris. A shallow groove is then turned in the cylinder with a narrow round tool, at its junction with the surface, or at the point where the length of the screw is to terminate; in order that the screw tool may cease to cut, and to allow time for it to be withdrawn, before the traverse carries the side of the tool into contact with the shoulder of the work; an accident which by suddenly checking the traverse of the tool, damages the thread. The screw, when struck and chased in the manner described, is then reduced to size and the tops of the thread to one level, with the flat tool; the screw tool is then re-applied with light pressure to finish the thread smooth and clean, but the action of the tool is not allowed to entirely obliterate the effect produced by the flat tool, the tops of the threads being much stronger when left slightly truncated, in about the proportion of fig. 512. The length of the screw is reduced last, the end being turned as a surface, and then slightly conical with the flat tool, applied at a little greater angle than that of the thread, to permit the end of the external, more readily to enter the internal screw.

For practice in cutting the internal screw, the aperture is hollowed cylindrical and rounded in front, fig. 513. The inside screw tool is held upon the arm rest, lying flat upon it, its surface radial; but first attempts may be sometimes

easier if made without the armrest, the tee of the hand rest being fixed across the mouth of the aperture. Except as regards the difference in the form of the tool and the use of the armrest, the method of striking the thread is virtually the same as that for the external screw, and is often more easily acquired.

The tool and armrest move together both in striking the thread and in chasing the screw, being advanced by the end-long thrust of the right hand, the left giving way, the body slightly swayed with the tool. The first stroke takes effect principally about the center of the curve turned at the mouth of the aperture; the line of points travelling in the curved path *a b*, and having also a slight *upward* tendency, from the advance of the tool being accompanied by a slight twist upon its handle to increase the penetration as described in the action of side cutting tools for hardwood. The second stroke

Fig. 512.

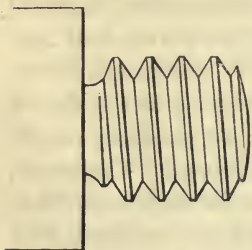

Fig. 513.

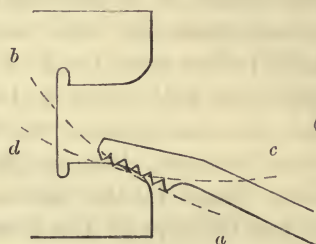

Fig. 514. Fig. 515.



on the line *c d*, drops into and continues the effect of the first, prolonging the screw line towards the cylinder, into and along which, it is then led by subsequent parallel strokes. The advance of the tool within the cylinder is guided by the screw line already obtained, cutting action being given by pressure with the right hand, accompanied by a gentle pull upon the armrest. The internal screw tool is always replaced in that portion of the thread, close to the mouth of the aperture, that can be observed; and so soon as this portion is cut with a thread of sufficient depth, the tool is replaced in it with only sufficient contact to carry it forward; the cutting pressure being added, when it is judged or felt that the tool has arrived opposite the unfinished portion hidden within the hole. The

least forward motion of the hand or body, at the completion of every traverse, disengages the tool from the thread.

Internal screws for practical use, figs. 514. 515, corresponding with the external lately considered, are hollowed as parallel holes, the external face surfaced, the edge of the aperture slightly rounded or bevilled, and a groove,—rather exaggerated in the figures,—to allow time for the withdrawal of the tool, is cut with the inside round tool, fig. 400, at the junction of the internal cylinder and surface, or at the end of the thread, as required. When the screw has been cut it is regulated to diameter and parallelism, with a right side tool upon the arm-rest, followed by the screw tool for clean finish; and then by the right side tool or flat tool, applied at an angle to the edge of the mouth, leaving that smooth and slightly conical.

The lengths of the external and internal screws for uniting two portions of the work, range from about one eighth of an inch, to about one inch, and often bear but a small proportion to their diameters. The two pieces are turned nearly to their respective diameters, and then the one reduced or enlarged to exactly fit the other in the process of cutting the thread. It is not very material which of the two screws be made first, but the internal thread must be always slightly the longer, to allow the shoulders of the two screws to arrive in contact. The external screw being more observable and accessible to measurement by callipers, is the more easily finished parallel; this is therefore more usually turned first, and the internal screw is gradually enlarged to fit it; but convenience in chucking, or the form of the work, may make it preferable to cut the internal screw first. External screws longer than their diameter, are nearly invariably cut first and their nuts then fitted to them. Screws cut in ivory, more especially upon portions of the work intended for frequent separation, suffer less wear and obtain increased smoothness of action, when polished with whiting and water, applied on the end of a slip of deal; which process is invariably followed with the best works.

It is occasionally necessary to cut the external screw at the chuck end of a piece of work, or the opposite position to the screw, fig. 511. In striking the thread in this position, the shaft of the screw tool is held at about right angles to the

mandrel axis, nearly parallel with the shoulder of the screw, which is cut from the groove towards the chuck; the action is rather cramped by the confined space between the shoulder and the chuck, but otherwise presents no difficulty.

Metal screws for fixing and adjusting purposes, when possible, are cut with the diestocks or other methods, detailed in the second volume and in this chapter; but a large number of screws in brass, gun-metal, iron and steel cannot be so produced, from unsuitability in their diameters or other proportions. Many of these are struck by hand in the manner described for wood, but with somewhat less facility according to the increasing hardness of the material, which renders the first traverse of the tool less certain. The penetration is considerably less and is also proportioned to the hardness of the metal, to avoid retarding the tool in tracing the first faint but accurate screw line, to be afterwards gradually deepened to form the thread.

Brass, gun-metal, and sometimes copper screws, are chased without lubrication, but oil or soap and water are generally used for the last; for cast iron the tool is dipped in water, for wrought iron and steel, it is plentifully supplied with oil to relieve the friction. The angles of the screw tools for metal range from 50° to 90° , varying with the material and somewhat, with the dimensions of the screw. Tools of the latter obtuse angle are used for the tubes of telescopes and analogous thin works, which do not admit of a groove at the termination of the thread. A narrow ring is sometimes soldered around the tube and the screw is cut upon it, when it stands above the line of the former; otherwise both screws are cut slightly taper, at a small angle to their respective tubes, when the screw tool cuts out free of the surface at the end of the thread. Cast iron requires coarse and shallow threads, produced either with a tool of considerable angle, or one with the points rounded, to give the thread the form of fig. 630 Vol. II.; the small cohesion of cast iron is not very suitable for external screws, they are little used and seldom cut by hand.

Very many iron and steel fixing screws, may be first marked out with the diestocks, and then have the bulk of the material

removed with the screw tool, the work mounted between centers. Equal pressure is maintained upon the tool that it may cut uniformly, and when desirable, the thread may be subsequently regulated and the screw made parallel, with the dies, carefully passed once or twice along its length. The sharp tops of the threads of iron and steel screws, may be slightly reduced with a flat file while in revolution, and the screws still revolving in the lathe, are then polished with fine emery and oil applied on the end of a piece of deal.

The hand screw tools may be made to cut double, triple, or quadruple threads, by employing a relatively increased speed in their traverse; thus, if the tool be moved twice as rapidly, instead of the series of points advancing as usual, the second to the position of the first, the third to that of the second and so on, in one exact revolution of the work; the third point will have arrived at the position of the first, the fourth at that of the second, one point passing over; when the thread resulting will be double, two coils winding round the shaft, their angle or rake twice that of the single thread. If traversed three times as fast as for striking the single thread, the fourth and fifth points, arrive at the previous positions of the first and second, two teeth passing over, when the thread will be triple. The double and the half thread frequently occur by accident, but striking them intentionally requires practice, while the triple and quadruple threads present considerable difficulties; the tool requires to be tilted at a great vertical angle to agree with the increased rake, and this, not easily maintained in striking the external thread, is almost insuperable with the internal. Multiplex threaded screws are more accurately and conveniently made by other means, and when intentionally struck by hand, it is usually as examples of dexterity.

SECTION II.—SIMILAR SCREWS CUT WITH THE TRAVERSING MANDREL.

The traversing mandrel produces both the external and internal screw with ease and certainty, it is therefore a desirable addition to the powers of the lathe, when the habit of striking screws by hand has either not been acquired, or

has been partially lost by disuse; it is also frequently necessary and to the most practised turners, to cut screws of difficult proportions, when the material is intractable, or when it only just suffices for the screw and a failure would be therefore irretrievable. The traversing mandrel, its screw guides and conducting apparatus, have been made in various forms, some of which have been mentioned; the modern, fig. 112, will suffice for explaining the manipulation, which is alike with all, and for cutting either wood or metal.

The piece for the external screw is prepared as usual, fig. 511: the cap at the back of the mandrel is then withdrawn and replaced by the screw guide, the corresponding segment of the conducting piece is placed uppermost, and the eccentric carrying it, turned round to bring the two into close contact. The eccentric is then slightly turned the reverse way, to slacken the contact and permit the mandrel to revolve easily but without end shake; upon which, the mandrel when revolving, travels at the rate communicated by the screw guide, advancing or receding as the lathe is turned in either direction. The screw guide and conducting piece are also sparingly supplied with oil, which completes the preparation of the apparatus. The cutting edge of the tool, and the tee of the rest, are both always parallel with the mandrel; and while cutting, the shaft of the tool remains at one exact spot on the tee without *any* lateral movement.

The fly wheel of the lathe is never permitted to make a complete revolution, but is only allowed to swing backwards and forwards, until the bend of the crank arrives a little above the horizontal plane, pointing alternately towards and away from the operator; necessary for the purpose of arresting the advance of the mandrel, to prevent the shoulder of the screw cut from striking against the left side of the tool and displacing it on the rest. The partial revolution of the fly wheel, being checked and determined, by the pressure of the foot on the treadle, at the termination of the upward swing of the crank in either direction. The action is regular and without jerk, the foot never leaves the treadle, but after giving its impulse for descent, its *pressure* is relieved until the crank completing its partial revolution has risen nearly to the highest point on the opposite side. The foot then checks the further ascent of

the treadle by gentle increasing pressure, almost instantly converted into an equally gentle impulse, which starts the fly-wheel back in the opposite direction. The easy, regular, backward and forward swing of the fly wheel, causes the mandrel to advance towards the tool, when the bend of the crank rises and points *from* the operator, and to retire from the tool, when it rises *towards* him.

The partial revolution of the fly wheel, effects several complete revolutions of the mandrel, which, measured on the work by any one point of the screw tool, produce two or three complete turns or threads, copies of those of the screw guide employed; and, as the screw tool remains quiescent laterally, the screw cut may be of any length within its width, plus the advance of the mandrel. This generally suffices for the length of the screw required, as the screw tools, which are the same as those used for chasing screws by hand, but matching the thread of the screw guides, vary with the coarseness of the thread, from about one quarter to about three quarters of an inch in width. The length of screw resulting from the advance of the mandrel and the width of the tool, may also then be increased if required, by lateral replacement of the latter.

The position at which the hand tool is to be held upon the rest for cutting the external screw, is first ascertained by trial. The bend of the crank having arrived at its highest point *away* from the operator, and thus determined the extent of the advancing traverse of the mandrel, the tool firmly held in the horizontal manner, is placed on the rest with its left side just out of contact with the shoulder of the work; which latter, retiring by the receding traverse, does not strike against nor displace it. The tool is then made to cut by pressure, or by slightly lowering the handle, it remains always in contact with the thread during its formation, the pressure only, being slightly reduced to relieve the friction during the backward traverse of the mandrel. After the thread has been distinctly cut by one or two traverses of the mandrel, the tool may be withdrawn to examine the progress, and in replacing it, it is only necessary to guide the points into the threads previously cut, again observing that the shoulder of the screw cannot reach the side of the tool. Screws of greater length than the width of the tool commands at one operation with the tra-

versing mandrel, are commenced at the end in the manner described, the tool is then shifted about half its own width along the rest towards the shoulder, and re-applied to the work; the thread being then continued in length by about half the teeth, the remainder dropping into that already cut, and guiding the position of the tool, to exactly connect the new to the finished portion. The length of the screw may thus be gradually continued to many times the width of the tool without break or irregularity; and when necessary, the thread may then be improved or the screw rendered quite parallel,—the traverse of the mandrel being exchanged for its continuous revolution,—by the correctional action of the numerous points of the screw tool, traversed from one end to the other, in the ordinary manner of chasing screws by hand.

The piece for the internal screw, is prepared to the form of fig. 515. The inside screw tool is held upon the armrest, the face about radial, and the line of its teeth parallel with the mandrel; the tool remains in one place without endlong motion, and is made to cut by pressure or by slightly twisting the handle. The manipulation is essentially the same as for the external screw, except in the support of the tool and the lateral advance of its shaft, differences due to form.

External and internal screws of all diameters, may be commenced and completed on the traversing mandrel so as to fit each other; or, which is sometimes convenient, so soon as the screw thread has been once transferred from the guide to the work, the traverse of the mandrel may then be exchanged for continuous revolution, and the diameter of the required external or internal screw may be reduced or enlarged, with the flat tool and screw tool, used in the manner already described.

The one constant position of the tool, whether a single point or a line of points, figs. 519. 520, the parallelism of its edge to the mandrel, and the certainty of direction, are perfectly secured when the tools are used in the slide rest. But the adjustment of the tool for distance with respect to the advancing traverse of the work, that the external tool may not be struck by the shoulder, nor the end of the internal tool, by the surface at the bottom of the internal screw, while it is very

easily made with the slide rest, is yet more necessary than with the hand tools. With the latter, the contact usually results in damage to the thread alone; in the slide rest, as the tool can neither yield nor be instantly withdrawn, it also is liable to injury; the collision besides damaging the thread, sometimes breaking the internal tool also. The tool is clamped in the slide rest with its face exactly at the height of center of the mandrel, the main slide parallel, or at right angles to the latter, for external or for internal screws respectively. The lateral adjustment of the external screw tool to the shoulder of the work, is made by the slide parallel with the mandrel, and the depth of cut is given by the upper or transverse slide; for the internal screw this is reversed, the tool is placed in position by the transverse, and advanced in cutting by the main slide.

In chasing the external or internal screw with the traversing mandrel when the tool is used in the slide rest, the tool is first placed so that its cutting edge is just out of contact with the work; then as the mandrel traverses, the tool is gradually advanced to the work by the screw of the appropriate slide, moved round by its micrometer head or winch handle, through a small space at a time. So soon as the cutting edge is found to arrive in contact with the work, the advance of the tool is only continued intermittently, and always at the moment when the work has receded, previously to the commencement of every forward traverse of the mandrel. Every advance of the tool when cutting is but small, the amount also depending upon the hardness of the material of the screw being cut; and the tool is not retired from the work until the thread is completed.

Softwood screws are cut in the lathe upon the traversing mandrel, and most conveniently, when the tool is applied by hand. The softwood hand screw tools, figs. 516. 517. 518, have a single point formed as an angular groove, the sides very similar to the edges of two chisels meeting in a point, but sharpened almost entirely upon their inner sides forming the groove, the same tool serving for either fine or coarse threads. The shaft of the external tool, fig. 516, is held upon the rest at a small horizontal angle, and slightly tilted towards the left, that the two sides of the cutting edge may agree with

the inclination of the thread; occasionally, as in fig. 377, Vol. II. the angular groove does not lie in the line of the shaft, the tool then requires to be held at an increased angle. The cutting edge of the internal tool, fig. 517, is at right angles to its rectangular shaft, which is held slightly underhand, and parallel with the axis of the mandrel; sometimes as in fig. 518, the shaft is cranked as with other softwood tools to increase its surface bearing on the rest. All these tools require holding with considerable firmness to avoid any lateral displacement, to which they are rather prone, both from being single points,

Fig. 516.

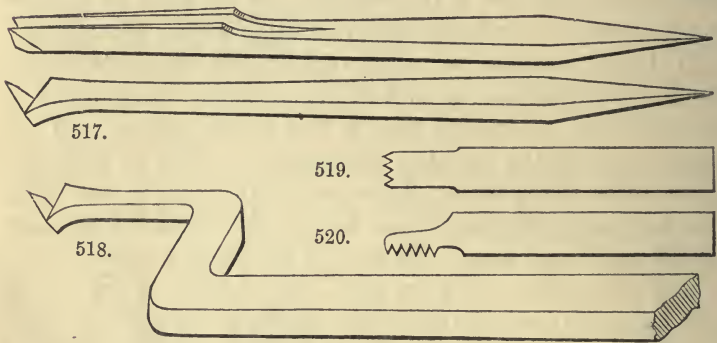

and from the avidity with which they cut; the shafts of the external tools are held inclined vertically, fig. 335, to present the cutting edges at the appropriate angle for softwood, which is that of the gouge or chisel upon the cylinder. When keen, the tools cut very readily and the finer threads are often completed at a single traverse. The tops of the threads are usually slightly truncated with the chisel, or a sufficient portion of the original cylinder may be permitted to remain when chasing the screw.

Softwood screws, especially those exceeding their diameter in length, are also very generally cut with the screw box, figs. 554—557. Vol. II.; a tool combining both guide and cutter. Every diameter of screw requires a separate screw box, and these, which all cut a comparatively coarse screw, a necessity in softwood, range in size for screws of from one eighth, to three or four inches in diameter; the smaller screw

boxes serving for many of the screws required in the following examples of softwood turning.

The piece for the external screw is turned cylindrical, rounded or pointed at the end, the shoulder true and square; it is then simply twisted into the hole in the screw box, which both guides the work and carries the cutter. The smaller screw boxes are used held in the left hand, the work being twisted in by the right, a moderate pressure in the line of its shaft being employed at the commencement of the cut. Long screws to about one inch diameter, such as those for tambour frames, are commenced in this manner, they are then replaced between the lathe centers, and the left hand is placed on the lathe pulley, to twist the work round and into the screw box, which is held by the right. Larger works, are placed upright in the vice, and the screw box twisted round by both hands. The thread is completely finished at one operation, and it may be arrested at any distance along the shaft of the screw, or it may be carried close up to a shoulder.

The internal screw is cut by a taper tap, the work having been previously surfaced, and a hole turned completely through it, or of sufficient depth, to allow the action of the tap. The smaller taps held in a hand-vice, are twisted into the hole with moderate pressure, care being observed to keep them perpendicular or in the line of the hole; the larger are used with a tap wrench. The wood tap with separate inserted cutter, fig. 552. Vol. II., requires less force than the large metal taps, and is a much superior tool for tapping large internal screws. The hollow metal tap, the principle of which is indicated by fig. 553. Vol. II., is the most efficient, but it is rarely made, unless it be required for the production of a large number of one size of internal softwood screws.

SECTION III.—SCREW CUTTING WITH THE SLIDE LATHE, OR SPIRAL APPARATUS.

Accurate and long metal and other screws, may be cut either in the slide lathe, or with the spiral apparatus; the details of both arrangements have been described, the manipulation of the two, the tools, and the precautions to be observed, given in this section, are analogous for either. The screw tools

employed are made with a series of points, with single points, or as small separate blades fitting into a holder, the stems by which they are clamped in the rest being strong and rectangular in all the varieties. The series of points is usually of less width than that in a corresponding hand screw tool, their shape and vertical angle as before, being cut on a hob made as a portion of a screw of the same thread and pitch they reproduce. This tool is advantageously used for making many copies of one screw, its action being both expeditious and correctional. The actual vertical angle of any one thread however varies with the diameter upon which it is cut, and being more acute upon the smaller, theoretically requires the teeth of the screw tool to have a different inclination for every diameter. No practical inconvenience is felt from this source, in cutting screws with the hand tools with or without the traversing mandrel, the hand permitting the face of the tool to acquire increased inclination, in chasing screws of small diameter. Neither does it present any difficulty with the class of screws cut with the traversing mandrel with the tool in the slide rest; so that with both these methods, the same screw tool may be used upon diameters rather largely differing from that upon which it was cut.

The fixed horizontal position of the tool in the slide rest employed with the spiral apparatus or slide lathe, together the more accurate character of the screw to be produced, more nearly limits the diameters upon which tools cut upon any one hob may be used; and when these are passed, the difference of vertical angle between the points of the screw tool and the thread of the screw produced, is shown by the heel or lower non-cutting portion of the points, rubbing against and deteriorating the thread cut by their upper edges. The thread of the screw being also now determined by the apparatus, the guidance of the numerous points is no longer essential, and these may be exchanged for tools with single points, figs. 604. 607. Vol. II., filed to different vertical angles, to agree with the rates of various threads and diameters. The single point tool, is indeed constantly necessary for many threads by reason of their great vertical angle or rake, and its cutting edge may be angular or square for cutting either shaped thread.

A series of single point tools, is conveniently replaced by the *Cutter bar for external threads*, contrived by the late Charles Holtzapffel, fig. 523; in which the separate angular or square blades of different facial widths and angles, are held by screws, bearing against their sides and upper faces, in a front socket. This is attached to the back and stem of the cutter bar upon

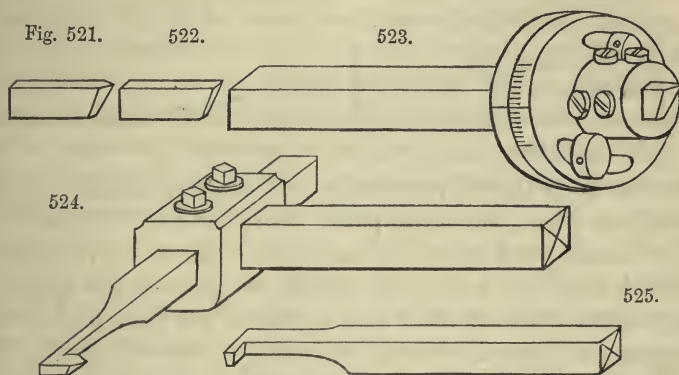

a central circular fitting, by two bolts in circular mortises, and moves round to place the tool to the vertical angle. The blades themselves are widest on the face, their sides being slightly taper in the direction of their depth, so that the side of the tool may be just free of the side of the groove it cuts; the necessity for the taper, increasing with the obliquity of the thread.

For rough purposes, and for turning ornamental spirals with a revolving cutter, the inclination of the tool to the vertical angle required by the pitch and diameter of the screw, may be sufficiently approximated either by allowing the point of the tool to trace a scratch, or by striking a line upon the work with a pencil held in the tool carriage, and then setting the tool by the eye to the inclination thus indicated. In cutting screws however that are required to have any degree of accuracy, more especially in metal, the exact inclination of the tool is absolutely essential. It may be calculated by the formula offered in the foot note, page 657, Vol. II., or the angle may be obtained with sufficient correctness and perhaps more

facility, by drawing and measuring the right angled triangle geometrically.

A perpendicular, a , is drawn to the base line A. B. fig. 526, at a distance from the zero, o , equal to the circumference of the proposed screw. The intended pitch is set off from the

Fig. 526.

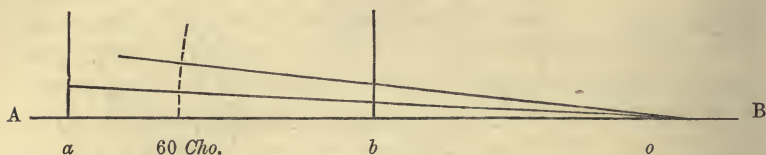

base line upon the perpendicular, and the hypotenuse of the triangle is drawn from that point to the zero, o . An arc of a circle, having 60 divisions of the scale of chords for its radius, is struck from the zero, o , as center, to measure the angle of the triangle; the chord of this arc, from the base line to the hypotenuse, measured upon the scale of chords, giving the

Fig. 527.

Fig. 528.

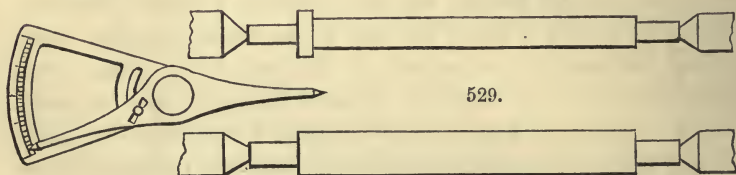

inclination required by the tool. Thus, for a screw of one inch diameter and of ten threads to the inch, the distance a , o , equals its circumference; the pitch, one tenth of an inch, is set off from the base line on the perpendicular, a , and the triangle completed. The angle, measured upon the arc drawn, and the measure transferred by the dividers to the scale of chords, gives two and a quarter divisions of the scale, from its zero, or $2\frac{1}{4}^\circ$, as the inclination for the tool. A screw of the same pitch, but of half inch diameter, would be represented by the distance b , o , equal to its circumference. One tenth of an inch, the pitch, is set off on the perpendicular, b , and the triangle completed; but in this case, the hypotenuse requires extending to the arc, for the measurement of the angle, which measured on the scale of chords, gives $4\frac{1}{2}^\circ$, for the inclination

of the tool. Every division of the scale of chords indicates one degree, but the distance between two of its divisions is readily estimated to one fourth, in reading the measure with the dividers; giving $3\frac{1}{4}^{\circ}$. $3\frac{1}{2}^{\circ}$. $3\frac{3}{4}^{\circ}$. 4° . or otherwise. The limit of angle of the tool for ordinary screws, usually lies between 2° and 4° for angular threads, and double these angles for square threads.*

The *Chord dividers*, fig. 527, an instrument suggested to the author by Mr. G. A. Ames, for prevention of error and convenience in measuring angles and in navigation problems has the two limbs continued beyond the center, the one terminating in an arc divided with the scale of chords, and the other in an index or reader; thus combining the dividers and the scale in one instrument. Fig. 527 is convenient for all the purposes to which the scale of chords is applied.

The loss of time between the main screw and the nut of the slide lathe or slide rest has been noticed, a similar interval occurs on reversing the direction of motion of change wheels; the effects of either are readily eliminated, but otherwise, they affect the traverse of the tool in screw cutting. An insidious, because less apparent but frequent loss of time, may also occur from separation between the work and its driver; arising in like manner from the reversal of motion, but also from some other causes; this cannot be neglected in accurate screw cutting and these matters may claim a few words.

The teeth of two wheels turning together interlace, one by one upon each, dropping in between two teeth of its neighbour. If their axes be too closely approached the wheels turn stiffly together, and when the axes of a train, or more than one pair are so placed, the motion is no longer even, but spasmodic and liable to jerks. The train of wheels for the slide lathe or spiral apparatus, carried by the arbors, mandrel and screw,

* At page 657, Vol. II., it is mentioned that "it is sufficiently near to consider the circumference as exactly three times the diameter." Should greater precision be required, the proportion that the diameter bears to the circumference may be taken more nearly, as 7 to 22, or still more exactly as 113 to 355. The latter proportion gives a result within one millionth of the circumference; and possesses the advantage of being easily impressed on the memory, by writing down the first three odd numerals in duplicate, and then bisecting the whole number thus written, 113/355.

therefore require to be approached in gear to run easily one with the other, yet without unnecessary freedom or shake between their respective teeth. But, as their agreeable action arises from the small amount of play between the teeth of each pair of wheels, it follows that the contact of neighbouring wheels, is only between the right and left sides of their teeth respectively, when turning to traverse the tool in the one direction, and between their left and right or opposite sides, when turning and traversing the tool in the reverse direction. The interval or loss of time, when by reversing the action the contact is transferred from the one to the other set of sides of the teeth, called "*backlash*," is more or less according to the distance between the axes of the wheels, and other circumstances, but it is always present and appreciable.

When the apparatus is set in motion by the revolution of the mandrel; if the tool be supposed to have traversed the work and to have cut a screw line upon the cylinder, and then to have been returned from the left to the right to its starting point, for the purpose of retracing the same line. Then, on reversing the direction of motion, that the tool may a second time travel from right to left; the change in the revolution of the mandrel is communicated to the work, either on the instant, or so soon as the driver comes in contact with the carrier. But the same reversal of motion, has to take up the loss of time between all the wheels, and between the main screw and its nut, before the tool can start. The tool, remaining thus an instant motionless after the revolution of the work has commenced, cannot drop exactly into the groove it has previously cut on the work; but, it engages against one of its sides only, widening the interval at that spot, at the expense of the thread. As the traverse continues, the loss of time is gradually absorbed, while the groove already cut also assists the tool to glide into its correct line, and the piece taken out of the thread is partial and not continued along it. The spiral apparatus, when used for the coarser ornamental spirals, is driven from the slide rest screw, and the slide lathe sometimes from its main screw; the tool then moves an instant earlier than the work, producing the same effect.

The backlash from the wheels, and that of the nut and slide rest screw, is neutralized by invariably traversing the tool

back, a little distance *beyond* the commencement of the thread, previously to reversing the motion to recommence. The loss of time being then entirely absorbed, before the tool commences to cut. The tool is never reversed in direction while traversing the work; and all cuts are taken in one direction only, from right to left or from left to right, as the screw required may be right or left handed in thread.

Backlash arising from separation between the carrier fixed on the work and the driver of the running center chuck, is less readily avoided. The act of running back the lathe and slide rest, tends to separate the two, and the liability exists even when they are bound together by wire, or fixed to each other by some of the other methods already alluded to. Some amount of heat is always evolved in cutting a metal screw, and this expanding the length of the work, causes it to move with more or less friction between the two centers as the screw cutting progresses; from which increase after many cuts, there is a risk of the carrier and driver becoming slightly separated, even when attached. Their separation is also more likely to occur when most undesirable, towards the completion of the screw; for the latter, may then move so stiffly between the center of the popit head and that of the chuck, that perfect contact between the carrier and the driver may not arrive, until brought about by the resistance of the cut.

The work therefore may remain stationary a small interval of time, until from the cut of the tool the carrier overtakes the driver; which results in damage to the thread, by a partial widening of its interval, consequent as before, upon the tool commencing to cut in a false path and then gliding into the true one. To avoid accident from this cause, the position of the carrier and the driver, when either unattached or fixed together, is always observed and the two are carefully placed in actual metallic contact by the hand, immediately prior to moving the tool at the commencement of every cut.

The rod or blank for a right handed, angular threaded screw, is mounted between centers and driven by a carrier; it is first turned truly cylindrical and then reduced to very nearly the external diameter of the screw. All metal screws, long in

proportion to their diameter also require the support of the back stay, figs. 142 or 143, or that of some analogous contrivance, fixed to the slide rest opposite to the tool and travelling with it; to counteract their bending, and to enable them to withstand the thrust of the tool, both for turning the blank and while cutting the thread. A portion at the right hand end of the blank, fig. 528, beyond the length, is also reduced until its diameter is slightly in excess of the diameter of the depth of the intended thread. Screws having similar shoulders at both ends of the thread, fig. 529, allow the tool to cut itself out free from the material at the termination of every trip; but this is prevented with fig. 528 by the collar or projection. Such blanks therefore, also require a narrow circular groove turned in them, at the termination of the thread and rather less than its depth; the groove, serving to receive the point of the tool and to allow time for it to be withdrawn, to avoid its fracture by sudden contact with the solid metal beyond the end of the thread cut.

The tool or the cutter bar, with the double angle blade first fixed at the necessary inclination, is then adjusted exactly to the height of center of the lathe by packing placed beneath it; after which it is clamped in the holder of the slide rest, with the circular portion nearly or else close home to the top plate. The stem of the cutter bar or of any other tool used in screw cutting thus receives no avoidable projection, so that the tool may acquire all possible stability. With the spiral apparatus, the height of the radial arm carrying the train of wheels, is also adjusted with reference to the diameter of the work with a view to the same result. These matters being satisfactorily adjusted previously to tracing the thread, the tool is advanced by the screw of the top slide until it just touches the cylinder, and its position is noted by the micrometer or divided head upon the screw; after which the tool is withdrawn clear of the work and traversed, until it stands *well* to the right of the shoulder, *a*, where it is brought to rest. The tool is then advanced a minute distance beyond that previously noted by the micrometer, and the lathe is set in motion for cutting. The loss of time of the nut and wheels being absorbed before the tool arrives at the shoulder, *a*, the continued progress traces a fine screw line along the work to the required length;

and as this is approached, the motion of the lathe which is slow, is gradually stopped to avoid overrunning the length of the thread, and to cause it always to entirely cease with the point of the tool in the groove turned in the work to receive it. The tool is then withdrawn by its slide, and the motion of the lathe being reversed, it is carried back to its former position on the right of the shoulder.

The faint screw line first traced, is to test that all the parts of the apparatus have been correctly fixed; if satisfactory, it is followed by a series of trips cutting the thread. The tool is slightly advanced while free of the work, prior to the commencement of the traverse from right to left and is withdrawn clear of the work, every time previously to its return to the position to recommence. The increasing depth cut by every advance, is carefully observed upon the micrometer of the slide rest screw, a wheel fixed upon it, the edge accurately divided with fine equidistant divisions and provided with a fixed index or reader, that the tool after being withdrawn, may be advanced slightly more than its last depth for the next cut, and also to prevent its being accidentally pushed too far forward, in which case it would tear the thread or be arrested and its point broken in the work. When the slide rest screw is unprovided with a micrometer, the advance of the tool, it has been said, has to be regulated by counting whole, half, quarter and less portions of turns of the screw; this is inconvenient in screw cutting, which usually requires a less advance, but a little help may be obtained by dividing the end of the tube of the winch handle into 10, 20 or more parts, read by an index fixed to, or by a line marked on the slide rest. This arrangement is improved, when the tube of the winch handle is cased with an external ring or short tube, carrying a projecting index point; which ring will slip rather tightly round upon it. While the tool is cutting, the index on the ring is shifted round slightly to the right of that upon the slide rest, to any of the divisions upon the winch handle to determine the depth for the succeeding cut; and when that is taken, the screw advancing the tool has only to be turned until the index on the winch handle is in line with that fixed to the end of the slide rest; the former being then again shifted to determine the depth of the next cut. With the micrometer, the tool can

be advanced and replaced at more minute distances, and it is also found very convenient to have a copy of the micrometer at hand, in the form of a dial, which may be set every time to the same advance as the tool, and referred to for the prevention of error.

The depth of the separate cuts necessarily varies with the hardness of the material, the diameter, and the shape of the thread; but it should always be well within the cutting capacity of the edge of the tool, and the strength of the cylinder being cut into the screw, even when that is supported by the backstay. The smallest advance is required for cutting threads in steel; and it may here be said approximately, that one hundredth of an inch is a sufficient advance for the tool at the commencement, in cutting most steel screws of either angular or square threads, the advance being gradually reduced to about one thousandth at the conclusion. In all screw cutting three or four comparatively light, produce a far better result than a less number of heavy cuts, but on the other hand the traverses should not be unnecessarily numerous, to avoid wear on the edge of the tool, which for iron and steel should be constantly supplied with oil to diminish the friction.

Frequently, and especially with long delicate screws, it is found advisable to take a second or even a third cut, without advancing the tool any deeper, the inherent elasticity of both screw and apparatus affording sufficient penetration to still remove a shaving; after which, the tool is again advanced a minute quantity and so on. Sometimes it is precisely the contrary, and it is found that after the tool has received its usual minute advance, its traverse produces no cut. This may arise in part from the elasticity or yielding named, and also in part from the effect of the heat evolved by the friction in removing the metal shaving. The cut should then be tried over again more than once, with the tool still at the same depth, before risking a fresh advance; when most probably in the course of the repetitions, from the subsidence of the interference due to elasticity or heat, it will remove its shaving.

The heat produced in metal screw cutting, as in plain turning, may be lessened by lubrication and the employment of a slow speed; but a small increase in temperature is often sufficient to sensibly elongate the work, which may cause the

screw to bend, producing irregularity in the thread. The elongation may render it necessary to ease the pressure from the confinement of the work between the centers, by slightly withdrawing the point of the popit head ; but it is a much safer practice to suspend the cutting from time to time, to allow the screw to cool. In some cases, when the screw has been partially cut in the lathe, it is advisable to pass it through a pair of dies, carefully cut on an *original* or *master* tap, fig. 551, Vol. II. of the thread and diameter ; the screw is then returned to the lathe and its further cutting proceeded with, and this alternation is sometimes repeated more than once. For these, among other reasons, it is apparent that metal screws requiring even tolerable accuracy, will not admit of being hurriedly executed.

The angular tool when placed at the correct vertical inclination required by the thread, cuts a shaving on each of its two sides, and when in perfect condition from grinding a double or angular shaving the shape of its point. As the depth of the cut increases, the two separate shavings or the two sides of the double shaving, gather up and bend over towards each other, impeding the cut and occasionally breaking the point of the tool, by a small portion of the metal removed forcing itself in between that and the work. Should the double shaving prove inconvenient, the cutter bar is slackened in the tool holder of the rest and very *slightly* shifted to the left, parallel to its former position, and the blade adjusted to the thread with only the left side cutting. Many, invariably adopt this system, cutting only by the one side of the tool so soon as the angular thread has acquired a little depth ; either shifting the cutter bar as described, or with the slide lathe, moving it a trifling amount to the left by the traverse of the slide of the rest that is parallel with the bearers. The single shaving then produced freely escapes, until by increasing depth the right side of the tool comes once more into cut, producing the double shaving ; when if desirable, the cutter bar is shifted again. As the thread approaches completion, and the advance of the tool is gradually diminished that a thinner shaving may leave a smoother surface, the last fine shavings are taken with both sides of the tool cutting.

Replacing the tool adjusted to the thread in the manner

described, presents no difficulty but requires care; the cutting edge it is apparent, also requires equally careful replacement both laterally and to the depth of cut, every time after the tool has been removed from the rest to be ground, an operation of rather frequent recurrence in metal screw cutting. The advance of the tool in the tool holder of the rest to the depth of the thread previously cut, is readily determined by the sense of touch, and is given by the hand. The correct lateral adjustment is determined by the eye, observation being generally assisted by a magnifier held in the hand above the point of the tool, and a piece of white paper laid on the slide rest below the screw. The tool is then slightly clamped, withdrawn from the work by the slide of the rest, to be sufficiently fixed, after which it is re-advanced and again examined, to observe whether the fixing has at all altered its relative position. No lateral adjustment of the tool, except that to cause the cut to fall only on one side, should be required with the cutter bar fig. 523; as this remains clamped in the rest, while the blade, which may be replaced in it with accuracy, alone is removed for grinding.

A minute width of the original cylindrical surface of the blank, is usually left to form the top of the thread, which would otherwise be too keen and liable to damage. The thread also forms a sharp knife edge at its termination with the shoulder, *a*; the sharp weak end is removed with the turning tool, the file or chipping chisel, according to the magnitude of the screw, until the section of the extreme end of the thread is sufficiently strong, and the screws are then polished by the methods described, pages 1072—3, Vol. III.

Square threaded external screws are cut in a similar manner; they are usually about twice the pitch of the angular threads, the original cylindrical surface of the blank left to form the top of the thread, being generally of the same width as the interval; the depth of the thread is also usually about equal to its width. A single square ended tool or blade in fig. 523. at the appropriate angle, cutting only upon the end, and a series of shallow cuts, usually produces both the sides and the bottom of the square groove forming the thread, at the same time. The groove required to receive the tool at the end of the trip, as before, is turned in square threaded screws of

moderate dimensions; larger screws, usually have a shallow, radial hole drilled at the termination of the thread, for the same purpose. The hole, rather exceeds the interval of the thread in diameter and it is drilled, its center upon that of the screw line, to a depth slightly beyond that of the intended thread.

External screws are usually fitted to their internal screws or nuts, occasionally the reverse; either operation is readily effected with angular threads, by simple reduction or enlargement in diameter. With square threads it is less easy, for besides the fitting in *depth* between the top and bottom of the respective threads, obtained by turning the external and boring the internal screws to their appropriate diameters, the square thread on the external screw must also fit that in the nut in *width*, or by the sides of the thread, and cutting the one to accurately fit the other in both particulars is rather difficult. It is perhaps most readily effected by making the tools to the exact dimensions of one half of the pitch, the width of the groove, and then very slightly reducing this width, to the extent of about $\frac{1}{2000}$ of an inch, by carefully applying one side of the blade upon a fine revolving lap. It is far safer that the tools should thus be rather below than above their true width; for it is obvious that in the latter case, the interval of the thread of the external screw would be too great, and therefore beyond correction or service, except by cutting the internal thread by a correspondingly thinned tool.

The tools for cutting internal threads, are very generally made with a single point standing at right angles to their stems, which are clamped in the slide rest parallel with the mandrel. The late Charles Holtzapffel's *Cutter bar for internal threads* fig. 524, carries separate blades with single angular or square points, that should agree in dimensions with the corresponding blades of the external cutter bar, fig. 523. The stem is held at right angles to the mandrel, presenting the shafts of the blades parallel with it, a position giving greater freedom of management than when the stem of the tool itself is parallel with the mandrel. The point of the inside screw tool, or the blade of the cutter bar, should receive a similar inclination to that of the external tool, but this entails difficulty from the

smallness of the space within which it has to work, and its unfavorable position compared with that of the external tool. The want of inclination occasions a marked difference between the form of the thread in the nut and that on the screw, and this, although unimportant for some purposes with the angular threads, renders it constantly necessary to make special tools with the cutting portion filed to the inclination required; indeed the inclination of many internal screws of both angular and square threads, is too great for them to be cut in any other manner.

When accuracy or many copies are required, it is usual if possible to employ taps for producing both forms of internal threads. The nut is cut by a tap or taps made from a portion of a screw similar to that upon which it is to be used, the external screw thus becoming the tool to impart its proportions to the internal. The construction of these taps and the entire subject, has been treated at length in the second volume. When the screw and the nut are required to fit absolutely, the former is made of slightly larger diameter than the tap, but only just sufficiently so, as to render it difficult to get the screw into the nut; the screw is then partially eased at one end and worked in, by employing as much force as the strength of the screw will safely permit. The external square threaded screw, is usually previously equalized by a very smooth flat file, carefully applied while the screw is revolving in the lathe; and in some cases, a grinder is used to ensure still further accuracy in the parallelism of the diameter.

The nut varies in thickness with its purpose. Thus for fixing or holding, a thickness equal to one diameter of the screw is found to present the maximum of advantages. Screws cut in the slide lathe however, are more usually required for moving slides and similar purposes; when to increase its durability or wear, the nut is seldom less than from one and a half to two diameters in length, and except when it interferes with the traverse it may sometimes be even longer with advantage. The nut is tapped prior to its reduction to external size, and the parallelism of its faces may be ensured, by partially turning them when the nut is in its place on the screw mounted between centers; the surfaces being finished by turning, filing, or planing under the guidance thus obtained.

Producing the internal screw by the tap, very frequently entails the additional labour of making a set of taps, expressly for one screwed hole, which also may be of exceptional dimensions; the proportions of the screw to be cut may also render the use of a tap quite unavailable; many internal screws therefore, have to be cut in the lathe, either on the question of suitability of means, or that of economy. The thickness of the nut or piece for these latter, usually varies from about one and a half to sometimes three diameters of the external screw. It is surfaced and bored with a parallel hole, carried in a chuck with fixing screws, or bolted on a surface chuck. Lifting pieces may be placed between the work and the latter, to afford a space for the tool to cut out free of the thread at the termination of the traverse. Or, the nut is made of greater length, and the parallel hole is enlarged by a groove turned towards the back end to receive the head of the tool; the enlarged portion, which has no thread, being subsequently cut off if required.

In cutting the internal thread the tool is advanced for the depth of cut, towards, instead of away from the operator, otherwise the manipulation of the apparatus is so similar to that for the external thread, as to require no description. Left handed screws, in which the thread winds around from left to right, either external or internal, are traced and cut under precisely the same conditions, and in the same manner as the right handed, except, that the tool travels along the cylinder in the reverse direction.

Metal screws with two, three or more threads winding around the same axis, have every individual strand cut after the same general method as a single thread; but the production of accurate multiplex threaded screws, is attended with increased practical difficulties, arising from their pitch, from the necessary attainment of uniformity in the depth and dimensions of their threads, and from some other causes; all of which require increased care in minute details of manipulation.

The threads of multiplex screws are more usually square, deep, and of a pitch that is considerable in proportion to their diameter. Hence, the tool theoretically, and frequently practically, requires an increased vertical inclination as it cuts

from the larger to the lesser diameter, that is, from the top, the surface of the cylinder, to the bottom of the thread, the depth to which the tool is allowed to penetrate. This is sufficiently obvious in the diagram fig. 526, which shows that $2\frac{1}{4}^{\circ}$, being the vertical inclination of the tool for a screw of the pitch of one inch diameter, an inclination of $4\frac{1}{2}^{\circ}$, or double, is required for a similar pitch upon half an inch diameter. Increased obliquity of pitch increasing the necessity. In some cases this difficulty may be surmounted by placing the tool at an angle suitable to a depth midway between the top and the bottom of the thread; but, when both pitch and depth are considerable, it becomes necessary to increase the inclination of the tool from time to time, during the progress of cutting the thread.

All the threads of a multiplex screw are commenced and their depth gradually increased, seriatim; as it is not advisable even with shallow multiplex screws, to proceed far with one thread, before the others have been considerably and equally advanced; the partial removal of material being liable to cause deflection. To avoid strain for the same reason it is frequently preferred to remove the bulk of the material from square threads, with a narrow tool, before proceeding to cut them to their full width. While for screws that are long compared with their diameter, and therefore more liable to bend from being comparatively weak, the cut may be gradually widened with a narrow tool, applied first to the one and then to the other side of the thread. These methods, employed primarily to diminish the strain of the cut to avoid deflection, also have the advantage of generating less heat from friction; the practical benefits of which have been already indicated. Notwithstanding every care however, the single or the multiplex threaded screw not infrequently becomes distorted or bent in the direction of its length; in which case it has to be removed from the lathe, and *set* straight by moderate blows, which are given with a lead or wooden mallet to avoid injury to the threads, the screw being laid upon a block of lead having a slightly concave surface. During this process the screw is replaced between the centers from time to time to observe the result; and the screw may even require setting more than once, prior to the termination of cutting the thread or threads.

Uniformity in the depth of the several threads of multiplex screws, may be assisted by turning down a portion of the blank at both ends, beyond the length of the thread, fig. 529, to serve as a gage. But in order to retain as much strength in the screw as possible, it is usual in the first instance to reduce the two ends to only about half the depth of the intended thread; and when that depth is reached by the tool, then to reduce them a second time to very nearly the finished diameter, but leaving still a very trifling reduction in this gage portion to be effected just before the threads are finally completed. A very close approximation to uniformity of depth may then be obtained by setting the tool to slightly touch the ends thus turned to the required diameter; but the threads should also be finally tested, by passing the tool, retained fixed at the same depth, along them all seriatim, that any differences, which may also have arisen from the wear of the tool, may be ascertained and corrected. Turning down both ends of the screw to serve as gage for size, is also very generally followed for screws having single square threads.

The nuts or internal screws for multiplex threads are usually cut first, and then the screws are fitted to them. Whenever possible, the nut should be finished with a thoroughfare tap; but it is very generally necessary, that the threads in the nut should be first partially cut in the lathe, in order that the tap may meet with no difficulty in obtaining the lead. The partial cutting being essential, whenever the pitch is considerable.

SECTION IV.—CHUCK AND SIMILAR SCREWS, TAPPED AND THEN CUT IN THE LATHE.

The short internal screws by which the lathe chucks are screwed on the mandrel, and portions of work on the external double screw chucks, figs. 298. 299, require truth and exact fitting; the chuck screws more especially, these should be made with *lathe taps*; the others, with similar, smaller tools, figs. 300. 301, employed in the same manner.

The set of lathe taps used for the mandrel nose of 5 inch center lathes, figs. 530. 531. 532, consists of a cylinder bit about five eighths of an inch diameter, a slightly taper entering tap of a diameter somewhat larger, grooved with four

cutting edges, and a plug tap. The plug tap should be a copy of the screw of the mandrel, and is generally grooved with five cutting edges. The lathe taps are usually about six inches long, and their rectangular stems are fitted into wooden handles ten or twelve inches long, which are bound at either end with strong metal ferrules. The opposite end of the handle of the cylinder bit has a metal center for the point of the popit head; those of the two taps are hollowed with cylindrical holes about three inches deep and of sufficient diameter, to easily admit the *cylinder* of the popit head. The handles are pierced with

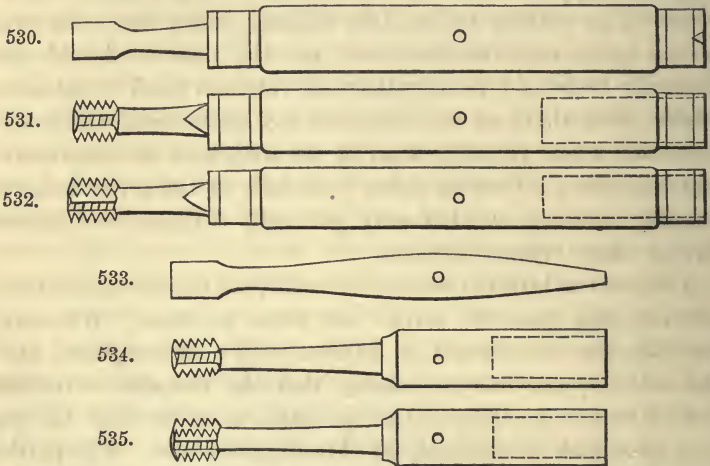

transverse holes for a lever. The ends of the metal stems are also provided with centers for use in screwing brass or iron, when the tools are more frequently used withdrawn from their handles. Lathe taps are occasionally made entirely in metal, when they take the form of figs. 533.—535.

The piece for the wood chuck to be cut with an internal screw to fit the mandrel, is mounted in a plain metal chuck, or more conveniently, in the universal chuck fig. 286; it is turned roughly true and has the face surfaced. A center is struck with a point tool, and a small hole is bored with a hand drill, to a depth rather exceeding the length of the mandrel nose, this is then enlarged with a right side tool to about half an inch diameter. The mouth of this aperture is then further enlarged to a depth of about one eighth of an inch to fit the

cylinder bit, the recess being left slightly taper to ensure the true bearing of the latter. The hole is then bored to the depth, the bit being advanced by the screw of the popit head, and prevented from turning round by a lever placed through the tranverse hole in the handle. The sharp edge upon the surface of the work left by the boring, is then slightly reduced by a flat or point tool, to assist the first entry of the tap.

The *entering* tap, slightly larger in diameter than the cylinder bit, is required to score an accurate screw line within the hole, to serve as a guide to give the path to the inside screw tool with which the bulk of the material is removed. The tap is retained exactly in the line of the axis of the mandrel, being controlled by the true hole bored in the work and by the cylinder of the popit head, which is advanced for about two inches within the axial hole in its handle. The foot being removed from the treadle, the mandrel is turned round towards the operator by the left hand laid upon the pulley, the right being clasped around the handle of the tap or holding the lever placed through it. As the mandrel is turned, the tap, always under the guidance of the cylinder of the popit head, gradually screws itself into the hole; cutting it with a shallow screw line until it arrives at the bottom, whereupon the motion of the mandrel is reversed, unscrewing and releasing the tap.

A groove is then cut at the end of the screw line, fig. 515, and the screw tool is used in the usual manner upon the arm-rest, first, to form the thread along its entire length, and then, to *fit* it to the *plug tap*, next employed as a gage for size, and also to a small extent as a cutting tool.

The screw is enlarged with the screw tool towards the face end, until it will just admit the first few threads of the plug tap, which is applied to the work under the guidance of the cylinder of the popit head, after the same manner as the entering tap; but the lever is generally dispensed with and the handle held by the hand. The enlargement by the screw tool should gradually diminish towards the back end of the thread, the screw being for the time slightly taper, so that on trying the plug tap its teeth should actually engage against the threads at the front end, but do little or no cutting; the advance of the tap being arrested, from the screw being too

small to admit its further progress. The plug tap is withdrawn and the screw tool used again, passing lightly without pressure over that portion of its path that admits the tap and cautiously enlarging the thread beyond. The plug tap is then tried again, and this is repeated, until it will screw up to the bottom of the thread.

The plug tap being the same size as the nose of the mandrel, if it have been correctly fitted, the screw tool may be again passed lightly along the thread slightly to enlarge it, that the chuck may more readily screw on and off the mandrel. The screw finished, the whole surface of the chuck is moderately reduced, except a ring about half an inch in width, around the screwed hole, which is left to form the face of the chuck; and this space is then turned flat and true, that it may bed fairly against the true face of the mandrel; the junction of the end of the thread with the face of the chuck being finally cleaned from any roughness, by being turned to a small internal bevil with a point tool. The cylindrical and front portions of the chuck, are turned true when it is screwed on its place on the mandrel.

The screws of metal chucks are tapped after the same manner, but the bit and taps are generally used withdrawn from their handles, to prevent the risk of these splitting from the increased strain. Both bit and taps are advanced by the point of the popit head, a hooked wrench or a hand vice affixed to their shafts, lying on the tee of the rest to prevent them turning round; which also leaves both hands at liberty, for advancing the tool and handing round the mandrel. The plug tap is also occasionally twisted backwards and forwards in the metal thread, to correct the work of the screw tool.

The metal chucks should not only fit the mandrel by the screw, but it is essential that there should be fairly exact fitting or agreement, between the face of the mandrel and that portion of the chuck with which it is in contact; called the face of the chuck. When therefore the screw is deemed satisfactory and the face of the chuck turned true and flat, the two surfaces should be finally adjusted to agreement. The chuck is screwed on the mandrel and by means of a lever inserted in

the lever hole, is once or twice forcibly screwed up against its bearing, to produce a mark upon the face of the chuck, upon that portion which bears the hardest upon the face of the mandrel. Unless this mark extends in a circular line, two thirds or more around the face of the chuck, the annular surface of the latter is then corrected by scraping with a triangular tool, after the manner described in the second volume for scraping a planometer. The chuck should then be tried again and the operation repeated, until a fair amount of bearing surface is obtained; complete agreement being very desirable for chucks requiring considerable accuracy.

The plug tap should be allowed to remove but very little of the material, that it may be protected from undue wear and its original dimensions fairly preserved; but it ensures the thread being a true screw, the correct diameter, parallel, and exactly in the mandrel axis; the two last qualifications being highly

Fig. 536.

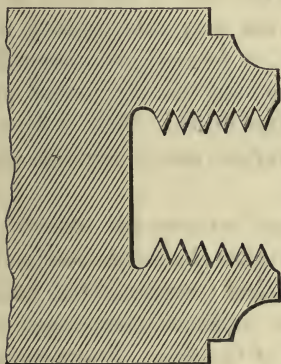
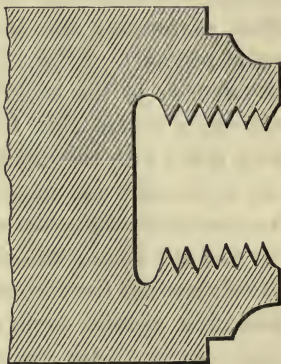

Fig. 537.



necessary in all chuck screws. It is essential to the permanent fit of the chuck, that the screw should be parallel; if it be taper in the direction of fig. 536, it only holds the parallel nose of the mandrel towards the end, and is too large towards the face. This chuck would be insecure and also liable to screw further round upon the mandrel, according to the force employed; such a chuck cannot be constantly removed and replaced on the mandrel without throwing the work out of truth. The reverse error, where the chuck screw fits the nose closely at the face, but has been turned out too large beyond, fig. 537,

interferes somewhat less with truth, but is objectionable in throwing the entire working strain upon that portion of the nose close to the face of the mandrel. The screws of hollow metal chucks are sometimes produced, but in an inferior manner, at one operation, by the use of a single taper tap, terminating in a cylindrical cutting portion. A hole is bored in the chuck true with the axis of the lathe mandrel, and of sufficient size to receive the taper end of the tap; the chuck is then placed in the vice and the tap is twisted completely through by means of a tap wrench. This method is inapplicable to all chucks in which the tap cannot pass through, and when it is employed, it is open to serious objection. The guidance derived from the popit head and the revolution of the mandrel being abandoned, there is nothing to replace it except the truth of the hole bored at right angles to the face of the chuck; but this guidance proves quite insufficient to prevent the tap assuming a position somewhat out of the perpendicular, or in disagreement with the axis of the hole, in the process of tapping the thread. This may arise, either from unequal pressure of the tap wrench, or from slight inequalities in the density of the material, which lead the tap to cut more freely on the one side than on the other. The screws of chucks made with the taper tap therefore, rarely or never absolutely agree with the mandrel axis.

Any deviation from the right angle between the axis of the screw and the face of the chuck, prevents the latter from screwing fairly against the face of the mandrel; and the two, instead of touching around their respective surfaces, then meet only at some one spot, at the outer edge of the face. The necessary contact being absent, the chuck is insecure, and vibrates upon its small and unequal bearing; added to which it will assume different positions on the mandrel while in use, screwing further round upon the nose, according to the force used with the lever in screwing it up to its place, and sometimes also, from a sudden jerk from the tool in turning; either of which places the work out of truth.

An appreciable error in the axial truth of the chuck screw, may sometimes become a source of danger to the nose of the mandrel. The force applied through the tool, or the effect of blows given upon the work, instead of being equally distributed

all around the mandrel, are all directed to the one point where that is in contact with the chuck. The tendency of this is to bend the nose, and in some cases with work of large diameter which affords increased leverage, or with a chuck having this fault highly developed, a blow or a sudden violent wrench from the tool, may sensibly bend and might even break off the nose of the mandrel. The single taper tap for these reasons therefore is a very undesirable tool for cutting chuck screws, and it is comparatively little used for the purpose, while it should be altogether avoided. Chuck screws made with the lathe taps and also the smaller screws for attaching work to the double screw chucks, figs. 298. 299, made in the same manner with similar smaller tools, on the other hand, should be entirely free from all these defects; except that it is possible to make them taper by careless use of the screw tool.

CHAPTER XI.

THE SPHERE, AND VARIOUS FORMS IN HARDWOOD AND IVORY
DERIVED FROM THIS SOLID.

SECTION I.—SELECTION AND PREPARATION OF THE MATERIAL.

THE sphere, among other purposes, serves as the foundation of many interesting examples of plain turning, among which, as in the Chinese ball and analogous works, it is used both as the envelope and as the gage for various forms turned within its substance; a few varieties of these, together with the employment of the sphere for the development of the five platic solids, may be briefly described as illustrations. In all these, the truth of the results depends entirely upon the accuracy of the original sphere; which however, may be produced by hand turning upon a system that affords a positive guide, and is consequently far superior to that of approaching the sphere through the polygonal section given to the material, described in a former chapter. The method pursued is the same for large or small diameters, for either hardwood or ivory, and will be conveniently illustrated by following the successive steps in turning a billiard ball, the sphere that is perhaps the most universally known and appreciated.

Judicious selection and preparation of the wood or ivory, is essential, that the accurate sphere produced, may suffer the least possible subsequent interference in permanency of form, from the natural and inherent contraction of these materials. The precautions to be observed will be first separately considered.

The structure and consequent changes of form that take place in wood and ivory, have been described at some length in the first volume of this work. Contraction and density, two of the qualities there referred to, exercise a very appreciable and unfortunate effect upon the sphere; but, as they are invariably present in either material, it becomes necessary so

far as possible, to evade or counteract their effects. Either material as produced by nature, considered in the form of a cylinder the lengthway of the grain, consists of an accumulation of longitudinal fibres, more closely bound together or denser around a center than at the circumference. This center of density may be nearly in the axis of the cylinder, *a b*, fig. 538, and as in the section fig. 540; or, more or less to one side, as in fig. 539. After being cut or opened, and the exterior reduced to the circular form, the material dries or seasons from contact with the atmosphere, by the gradual evaporation of the contained moisture. During which natural process, all the fibres contract around the center in the transverse direction, *c d*, and rather considerably, when compared with their contraction in length *a b*, in which direction they diminish very slightly. The shrinkage always preserves the same ratio, and

Fig. 538.

Fig. 539

Fig. 540.

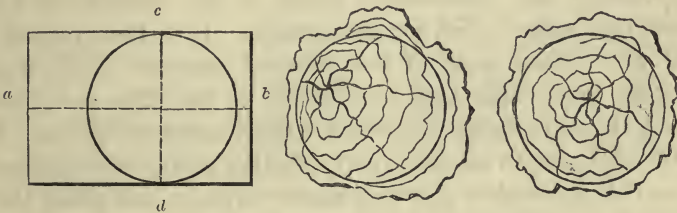

the process, although diminishing in effect with time, is long, and may be considered as almost indefinite.

The unequal contraction between the long and the transverse section of the material cannot be avoided; the hardwood sphere therefore, is at first only turned as a rough approach to the spherical form, and is then left to season. To attempt greater exactness would be useless, as an accurate sphere made from insufficiently seasoned material, would rapidly become an oblate spheroid, of longer diameter through the axis *a b*, in which direction comparatively little contraction takes place. The roughed out sphere, its entire surface being exposed to the atmosphere, contracts more rapidly than the cylinder. It is left to season as long as may be necessary, which depends upon the dryness of the wood previously to the first turning;

and it should be kept in a dry place free from heat or draught, either of which may possibly cause it to split. The hardwood sphere may be finished at the second turning, or, if greater permanency be required, after further preparation as with the billiard ball.

The thorough seasoning of billiard balls is of the first importance, and hardly too much care or time can be given to it, so as to reduce the possibility of contraction in the finished balls to a minimum. The ivory ball after it is first roughed out, should be allowed to remain at least six months to shrink or season; it should then be turned a second time, with care to approach the spherical form, and to equalize the length of the axis, *a b*, fig. 538, to the diameter of the circumference *c d*. This second turning should leave the ball about one sixteenth of an inch larger than its proposed finished diameter.

An entirely fresh surface being thus exposed to the atmosphere, the ball again contracts on that account, and also from the constant but diminishing action of the material, and it should now again be left for six months. It is then turned a third time, when most of the material removed comes from about the ends of the axis *a b*; leaving it less than one thirty second above its finished size and a fairly accurate sphere. It is still advisable to allow the ball a further period of seasoning, before it is finished to size by a fourth turning; and a ball thus prepared is usually very permanent in form. But even with these precautions, it is good practice to leave the finished balls a trifle larger than their reputed size, that after they have been some time in play and have become acclimatized to the temperature of the billiard room, they may be once more corrected, to render them still more permanent and accurate. This long and careful preparation is too frequently curtailed; it is however the only means of counteracting the natural shrinkage of the ivory, and when neglected, the billiard balls cannot remain true.

The growth of ivory and of most of the hardwoods, takes place by the deposition of the fibres, layer after layer around a center; and in both, in some measure from the compression of the external layers and from other causes, the material is

denser the nearer it is to the center. It is not usual however that the growth of the layers is quite concentric, that is, that the rings are equally distant at all parts from the center of the growth; which center also, is not necessarily central to a transverse section of the tree or tooth. In ivory, the section is always more or less oval, while in wood, it is frequently very irregular.

Variation of density around the axis of the sphere in the transverse direction, *c d*, the second quality referred to, arising from irregular growth in the material, can be greatly reduced by suitable selection, so as to place the axis of the ball, as nearly as possible coincident with the center or axis of the dense portion of the wood or ivory. A section of wood such as fig. 539, would be avoided, because the axis of the ball could not coincide with its center of density. The denser and

Fig. 541.

Fig. 542.

Fig. 543.

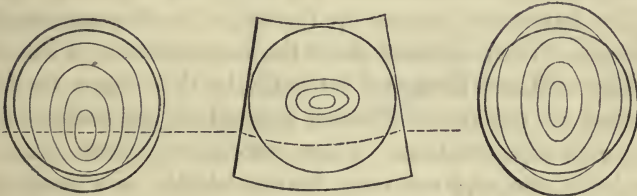

slightly heavier material would preponderate on the one side, and give the ball a bias or inclination to follow that side in rolling, forcing it to roll in a curve instead of in a straight line. Wood of suitable section for the sphere, fig. 540, permits the axis of the ball and the dense center in the wood to be nearly or quite coincident, and moreover, the wood from having grown of more nearly circular section, is itself concentric.

The growth of the elephant's tooth is more regular, and whatever the section, except from some accidental circumstance, the rings or parallels may be considered as concentric. Teeth are however met with, in which the nerve the center of density, is not central in the section; this is exaggerated for illustration in figs. 541. 542. and such a tooth would be very unsuitable for a billiard ball, as the latter would largely possess the bias referred to and could not possibly roll straight. The

nerve therefore should coincide as nearly as possible with the axis of the ball. The most suitable ivory is obtained from teeth far more nearly round than fig. 543, in which, although the conditions of density are favorable, the section is objectionable. A ball from so oval a tooth, would have one pair of sides from a denser, and the other pair, from a lighter portion of the section, perfectly balanced and merging into one another, but owing to the unequal and varying density of the sides, there would now be unequal and varying contraction in the section of the circumference *c d*.

Another practical difficulty arises from too oval a section in the tooth, which renders the finished ball very liable to scale upon the two sides that are nearer to the bark or exterior; which are coarser and more fibrous than the other pair, formed by the more internal portion of the ivory on the long diameter of the oval. The oval lines representing the quasi-concentric layers of ivory, and the circle, the section of the ball through its circumference, fig. 543; are intended to show that the latter cuts across the former, in such a manner that the layers of ivory situated about the long diameter of the oval, are supported and protected laterally, by those upon the short diameter, the outermost of which themselves are entirely without any such protection. These outermost layers from the flat sides of the oval are very distinguishable as a mark upon the surface of the sphere at its circumference, fig. 542, formed by the edges of the super-imposed layers; the external and shortest of which is completely without protection, its permanency of attachment depending only on its surface contact. The second layer is the same as to its edges, but is a little protected by the first lying above it; the third is still more strengthened and so on; until the lower, merge into or become the protected layers upon the long diameter. The unprotected, outer layers being also the coarsest part of the ivory, have a tendency to catch against the tool, sometimes leaving the surface rough or cellular, portions occasionally splitting out. Although in the production of the sphere this may be avoided by skilful turning, balls that are made from ivory of too long an oval section, will not continue in use without damage from the external lateral fibres splitting, or, from an entire layer scaling off.

The form of the elephant's tusk may be generally described as a long cone tapering to a blunt point, hollow for about one third from the larger end, and more or less curved in the direction of its length; its peculiarities, uses, and the various methods of its preparation, are given in the first volume. The teeth used for billiard balls, fig. 544, are selected as *straight* and as *round* as possible, they are known as "ball teeth" and are more nearly solid. Usually only one ball of each size, is cut from each tooth. A point is first determined at which the diameter is just sufficiently large, for say, a 2 inch ball; which position, varies both with the section and with the thickness of the bark of the particular tooth. One inch is marked off on either side of this point, and then using the frame saw, fig. 49, Vol. I., the tooth is cut through on the outer sides of the marks, leaving a block of no more than sufficient length for the 2 inch ball. The next piece cut off in the same manner,

Fig. 544.

Fig. 545.

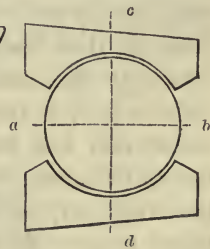
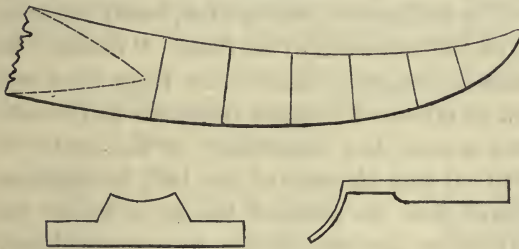

Fig. 546.

Fig. 547.

generally serves for a $2\frac{1}{16}$ inch ball and is of corresponding length, and to this, should follow the $2\frac{1}{8}$ inch and larger sizes; all the cuts being made radially to the curve of the tooth.

It occasionally happens that the tooth tapers too rapidly, or not sufficiently, to permit this regular progression. Sometimes with insufficient taper, two blocks may be cut consecutively, intended for balls of the same size, but this is rather infrequent. For the reverse case or too rapid taper, if after a block has been cut, suitable say for a $2\frac{1}{16}$ ball, the next portion of the tooth should prove too large for a $2\frac{1}{8}$, and yet not large enough for either a $2\frac{3}{16}$ or a $2\frac{1}{4}$ inch ball; a thin slice is then first cut from the tooth and laid aside for some

other purpose, when the succeeding portion produces the larger ball block. The value of this system, consists not so much in economy of material, as in uniformly obtaining the ball from a block that is no larger an envelope to it than is unavoidable ; and taking an extreme case as an illustration, a very sensible difference in density and weight, is found to exist between a ball from a ball tooth, and a similar ball turned from the central portion of a tooth of large diameter. Billiard balls taken from similar positions in selected teeth approach very fairly in this particular, and would still more nearly, had they not to contend with the varying specific gravity of the different teeth.

Mr. Myers, gives the sizes of billiard balls and of blocks cut in the trade, as ranging from 2 inches, increasing by sixteenths of inches, to $3\frac{1}{2}$ inches diameter. The sizes to $2\frac{1}{8}$ inch only are used in England, the larger sizes on the Continent, the largest sizes being required for the South American market alone. Foreign orders for billiard ball blocks usually reach him expressed in millimètres, and are frequently at closer intervals than that of the sixteenth of an inch. "Owing" he says "to the immense demand, almost any ivory that will make a ball, is used or mis-used without reference to its suitability and will find a sale; the desirability of the center of the tooth being identical with the axis of the ball, is therefore too frequently ignored, but, the selected blocks in which the nerve is near the axis of the ball, obtain a correspondingly enhanced price."

An exceptional method of preparing the billiard ball, fig. 545, arose from a demand for ivory rings for exportation to the East Indies, for bangles manufactured and used by the natives, and has been occasionally followed. The rough balls of $2\frac{1}{2}$ to 3 inches diameter, are cut with a curved tool, fig. 547, passed around their surface, from the center of solid blocks measuring 3 by 4 inches and upwards. The tool may be guided by hand, after the manner described in a later portion of this chapter, or more successfully in a slide rest having a circular movement. The two ends of the block are first recessed to a diameter rather exceeding one sixth of the circumference of the intended ball, the bottom of each recess being also turned to the curve of its surface, and the sides to an angle, to permit

a sufficient traverse to the shaft of the tool. The two sixths of the ball thus formed and the sides of the apertures, are turned to a template, fig. 546, leaving the axis, the distance a to b , rather more than the required diameter. The existing portions of the ball then serve to assist the guidance of the tool, applied by hand or otherwise, in cutting around it to the diametrical line $c d$. The block is then reversed in the chuck, and the remaining portion of the ball cut free from the other face; after which the ring is divided through the line $c d$ to form the pieces for two bangles and obtain access to the ball. The result is usually about equal to a ball first roughed out in the ordinary manner.

SECTION II.—CHUCKING AND TURNING THE BILLIARD BALL
AND ACCURATE SPHERE.

The preliminary turning slightly differs for hardwood and ivory. The polygonal method may be roughly followed for the former; but, as this guide is to be superseded by a better, the ball is more generally roughed out direct from the cylinder,

Fig. 548.

Fig. 549.

Fig. 550.

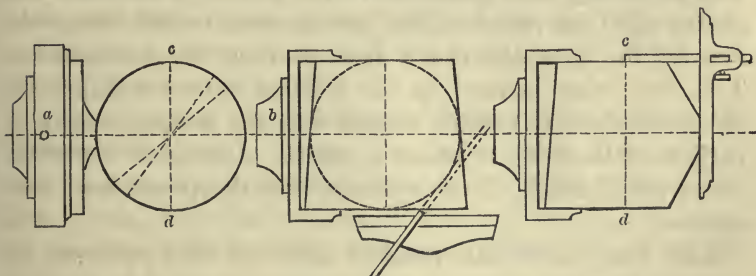

fig. 548. Taking the precaution to measure with callipers, to ensure that its axis $a b$, is not less than the diameter of the circumference $c d$; and also that the contour of the ball, measured across at various angles, indicated by the dotted lines, is nowhere of less diameter.

The ivory ball block, being of no more than sufficient length, no part can be cut to waste or left in the chuck. A circle is first scribed upon one end, placing the nerve as nearly centrally as possible, and the bark having been removed, the

block is roughly rounded to this circle with the paring knife, and placed in a strong wood or metal plain chuck, fig. 549. It is then adjusted with the hammer, that the nerve in the external face may also run as nearly centrally as the ivory will permit, and the block is then turned cylindrical with the gouge.

Owing to the curvature of the tooth the ivory block is a segment of a circle, to which its two faces are about radial, and therefore, not at right angles to the mandrel axis. The exposed face could not be turned to a surface, without reducing the more prominent angle until it fell within the lesser, fig. 549, which would reduce the length of the block, and make the axis of the ball too short; instead therefore of surfacing the block, a ring is cut off from the end, which may be saved for other purposes. A thin parting tool, entering at an angle upon the cylinder, but without encroaching upon the ivory required for the sphere, is made to detach the ring by cutting through to the surface left by the saw; leaving a portion of this surface, about an inch diameter intact, to maintain the original length of the block, or axis of the ball. A set square held vertically touching the space left at the center, fig. 550, with its sliding steel blade set to the radius of the ball, and resting upon the cylinder, may now be used to find the position for the circumference, $c d$, determining the hemisphere. This line being marked on the cylinder with a lead pencil, the hemisphere is roughly shaped with the gouge; leaving a portion of the surface, about a quarter of an inch diameter, and a small width of the cylinder with the pencil line, untouched.

The block, now half roughed ball and half cylinder, is released from the chuck by a slight blow on its side, and reversed to turn the other half. This requires another chuck, but is in other respects a precisely similar operation, and it is usual to turn the first sides of a number of balls, and then changing the chuck, to turn their other sides. A plain wood chuck, fig. 551, is used to turn the second side; this chuck is turned true, very slightly taper inside and accurately faced. The aperture at the face, is rather less in diameter than the diameter of the hemisphere; when, provided the chuck be of suitable angle, the elasticity of the wood gives the work

sufficient hold. The block is pressed into the chuck with the fingers of one or both hands, until the pencil line at its circumference runs truly with the true face of the chuck; the adjustment of the one to the other being effected by pressure of the hands on different points on the face of the block. When truly adjusted, a few light blows are given upon the end of the block with the hammer or with the end of the arm rest handle, after which the ring is cut off as before, and the second hemisphere roughed out to shape. The second side is thus fairly true to the same axis as the first, both agreeing with the same base line at the circumference, $c d$; no attempt at further accuracy is made in this first turning, after which the rough balls are put aside to season.

The sphere may be described as a solid contained by a semi-circular line, $a c b$, fig. 538, revolving around an axis $a b$; every portion of its surface at exactly the same radial distance from a common center, the planes of all its peripheries radial.

The circumference $c d$, and the similar periphery at the axis $a b$, have their planes at right angles, and pass through each other at two points on the surface; and all other similar vertical peripheries at an angle to $c d$, fig. 548, also pass through the same two points.

The mechanical demonstration of these axioms in the lathe, produces the accurate sphere; the system followed consists in first forming the circumference $c d$, and then reducing to this, by its revolution as a gage, the periphery in the plane of the axis $a b$, together with every other portion of the surface.

Positive concentric truth in the wood chucks employed is essential, for if the aperture of the chuck be not perfectly concentric with the mandrel axis, the two hemispheres cannot possibly be turned exactly upon the same base. They would be in some degree like a ball cut in halves, the two halves slid slightly upon each other, instead of precisely opposite as when the ball was solid. The angle in the aperture of any of the chucks, figs. 551 to 559, is about 2° , measured at the surface, where its diameter should be something less than that of the

ball, so as to embrace the latter at about 10° to 15° from its circumference. The surface or front edge of the chuck, must also run exactly true; and, as the aperture is enlarged by correction, the face is turned away so that the chuck may always remain the required size. The ball when held in the wood chuck at about the point described, is very secure, so much so that it is sufficiently firm for all the finishing turning when simply pressed into the chuck by the hand; by which also it may generally be as easily removed to be re-adjusted. Whenever the wood chucks have not been in immediate previous use, lest they may have warped in the smallest degree, they are first corrected to ensure their possessing the necessary concentric truth; a right side tool held very firmly, is used both to reduce the aperture and face to exact truth, and also, to carefully preserve the same degree of internal taper. The chucks often require correction day by day, and in warm weather sometimes still more frequently; and those in which the balls are turned are never used for polishing, to avoid alteration in their truth from the moisture; an old chuck being used for this purpose.

In roughing out the ball for seasoning, the nerve or the lengthways of the grain, has been hitherto always in the same direction as the mandrel axis; but in finishing, the ball is first placed in the chuck, fig. 552, with the nerve at right angles to the mandrel or in the direction of the line *c d*. The circumference, now to be turned and used as the gage for size and form, thus lying in the direction of the grain, in order that when first turning the hemisphere to it, the tool in passing around the curve from *b* to *c*, fig. 554, may cut smoothly with the grain, and so avoid a great portion of the risk of leaving the cellular surface before alluded to.

The position of the circumference *c d* fig. 552, is first marked. This may be measured as before with the turning square, fig. 550, but it may be more exactly determined, by striking a pencil line on the ball while in revolution, close against the face of the chuck, then reversing the ball and re-adjusting this line to run true, and then striking a second, also close against the face of the chuck. After which the width enclosed by the two lines, is bisected and marked on the ball by the pencil line *c d*. A band or flat about three eighths of

an inch wide, is then turned around the circumference with a narrow flat tool. This band, $d e c$ fig. 552, should be concentric, slightly larger in diameter than the finished size of the ball, and parallel, as measured by the callipers or the parallel gage, fig. 553, and the circumferential line absorbed in it, should be exactly in the center of its width; all readily attained in the lathe. When deemed satisfactory, the tool is exchanged for a hard pencil, and the entire surface of the band is covered with the black lead; after which the ball is released from the chuck.

It is replaced with the axis $a b$, at right angles to the mandrel axis, and the plane of the circumference $c d$, parallel

Fig. 551.

Fig. 552.

Fig. 553.

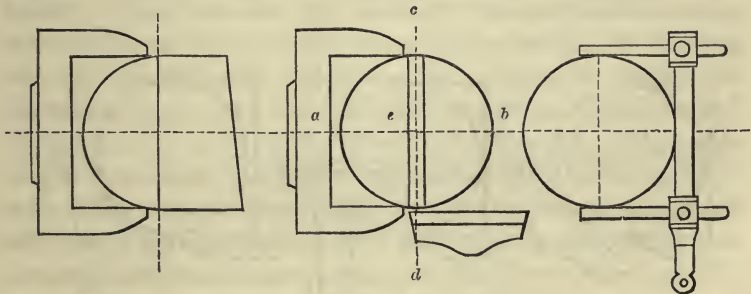

with it, fig. 554. The band $d e c$, is therefore half within and half without the chuck, the ball revolving upon the new axis $d c$, or the diameter of the circumference. The true semi-circle of the circumference, $d e c$, seen in plan in fig. 554, and in elevation in fig. 555, therefore revolving around an axis, describes the sphere; its revolution being moreover gaged by that of its other half, forming the complete circle $d e c f$, ensuring that the circumference or band revolves upon its diameter as axis and describes a sphere and not a spheroid.

The circumference contained by the band, $d e c f$, cannot however truly describe the sphere until adjusted; being held in the chuck by adjacent portions of the rough ball, from various circumstances not true with the band. Thus the *plane* of the circumference $d c$ fig. 554, may not coincide with the mandrel axis, but may stand at a lateral angle, c , being slightly either

to the right or left. Secondly, also owing to inequalities in the surface of the rough ball, the *axis d c*, fig. 555, may not coincide with that of the mandrel, but may be at a small vertical angle to it, *c*, being slightly above or below the true line. In either case the gage of the circumference will be inaccurate, but the revolution of the lathe and a turning tool, detects either vertical or lateral misplacement, and points out the required adjustment.

The coincidence or otherwise of the *plane*, fig. 554, is shown when a small gouge is applied to the ball anywhere between *b* and *c*, and allowed to cut a ring all around the hemisphere, sufficiently deep to arrive at the band. Should the plane coincide with the mandrel axis the tool will encroach

Fig. 554.

Fig. 555.

Fig. 556.

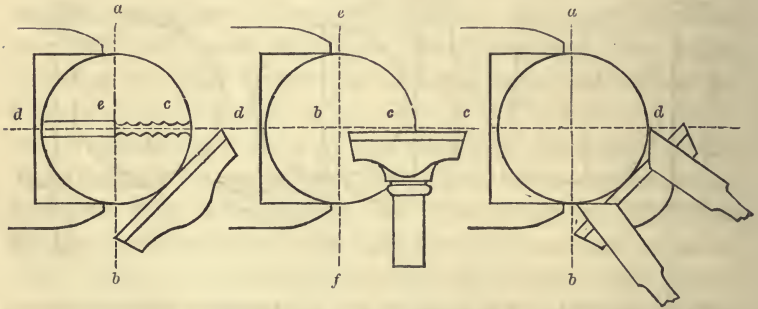

upon an exactly similar quantity on either edge of the band; usually, the ball is not correctly placed, when only one edge of the band will be cut, or the one edge deeply and the other but slightly indented, shown by the amount of black lead that the tool removes from the band. The gouge is used for these trials with some caution, for should the lateral misplacement be large, it may cut too deeply into the substance of the ball, before it can arrive at the band; a slight surface incision will detect this probability, whereupon the ball is withdrawn by the hand and readjusted in the chuck. Slight errors are corrected by light blows with the end of the handle of the tool or arm rest, given upon the prominent or *cut into* side, causing a slight rotation of the ball upon the axis *e*, fig. 554, and making the high side of the ball enter further into the chuck. The

gouge is then tried again, and the operation repeated, until the tool touches equally upon both sides of the band $a c$ and $b c$.

The vertical agreement of the *axis* of the circumference $d c$, with the mandrel axis, fig. 555, is determined simultaneously. Should the former be at an angle, placing c , much too high, the gouge may cut into the band between $e c$, and miss it altogether between $f c$, or more usually, it will cut deeper on the one side of the hemisphere than on the other. An analogous correction is required, the axis, b , has to be slightly moved; light blows upon the high side, making f , or e , enter further into the chuck, as c , may prove to be too high or too low.

When the circumference has been exactly adjusted in the two directions, the hemisphere is first reduced with a small gouge, about one quarter of an inch wide, and in a short handle. The gouge lies upon its back very nearly horizontally, the handle a little lower, it is held close to its cutting end, the shaft always *radially* to the sphere; the position of the hands around the tool and the rest, being that described for the horizontal position in hard wood turning. The rest is placed at an angle, and sufficiently high for the cutting edge of the tool to be also about radial; its surface should be smooth and free from imperfections, that the gouge or the chisel which is used subsequently, may not meet with the smallest impediment to their even traverse around the ball.

The gouge or other tool employed is swept about two thirds around the curve from b to c , fig. 554, the thickness of the shaving being made gradually to diminish towards the termination; the tool is then applied at the center c , and traversed in the opposite direction over the remaining third, this shaving also lessening in substance as it overlaps the previous and opposing cut. The rate of the traverse is always very slightly accelerated in passing from b towards c , and retarded from c to b , rates of motion necessary for the varying diameters upon which the tool is acting, that it may remain at each part of its traverse only a sufficient time to remove a uniform thickness from all around the hemisphere. The lathe mandrel revolves at a high rate of speed, the driving band running on the smallest groove on the pulley and on the largest on the fly wheel; a still higher speed is employed with

the foot lathes of the billiard ball manufacturer, who, for this purpose reduces the groove on the pulley to the smallest diameter that will allow the band to clear the lathe bearers. The driving band is also always allowed to be very slack, to permit the mandrel to be stopped for a moment, to examine the progress of the work without checking the lathe. The left hand being laid on the pulley to arrest it, the loose band slips, but immediately recommunicates the motion when the hand is removed; should the band at any time prove too slack, it is unhooked and twisted, as described page 56, so as to slightly increase its tension.

The tool encounters the flat band *d e c*, twice in every revolution of the ball, which every time causes a break in the continuity of the cut; it therefore requires holding steadily, to prevent its accidental advance to the surface of the band, until the intermittent cutting has sufficiently reduced the sides. At the same time the hands are not rigid, which would interfere with the free traverse of the tool. This is effected almost entirely by bending the right wrist, the forearm moving horizontally upon the elbow, which remains nearly stationary, the wrist being bent or straightened in carrying the tool around the curve, to which its shaft is always radial.

The gouge is employed until the band *d e c*, is reduced to about one third of its original width, its edges equally serrated by the tool, so that it still maintains a tolerable parallelism. The gouge is then exchanged for the flat tool or chisel, with which the surface of the sphere is finished; these act solely as scraping tools; having to meet the grain or fibre of the ivory at all possible angles. Thus in passing over the fibres on the side of the ball, indicated in fig. 542, in the one direction from *c* to *b*, fig. 554, the tool meets them more or less against the grain and has a tendency to cut roughly. On leaving them, in the other direction from *b* to *c*, it travels with the grain, cutting perfectly smoothly. These surface conditions however constantly vary with the changes of axes given to the ball; and the tool is always cutting at one moment with the grain on leaving one set of fibres, and then immediately encountering the ends of another set against the grain and so on.

A scraping tool best meets these conditions, and obtains a fine continuous shaving in all directions of the grain, but it requires

to be very keen and to be kept constantly sharp from the oil-stone. The chisel used is about one inch wide, and is ground in all respects as for soft wood; while the angle formed by the cutting edge with the shaft of the tool, is also found to very greatly assist the hand in carrying the cut equally around the curve. The flat tool is also ground to a long bevil, and both tools are used in short handles. The flat of the blade immediately behind the bevil, is laid flat on the top of the rest, and the left thumb is brought over on to the top of the blade, to keep the two in contact and as usual, to aid in propelling or retarding the tool in its traverse. Any accidental slip forward of the tool, making too deep a cut, necessitates the reduction of the entire surface of the sphere to the same depth, which may also reduce it below the required diameter. As a precaution against this accident the flat sides of the chisel may be laid transversely upon the grindstone, and the top surface of the rest rubbed in the direction of its length, with a piece of emery paper wrapped round a file or other flat object. A slight grain thus replaces the extreme smoothness acquired from use, giving the respective surfaces a little hold upon each other, sufficient to impede the advance of the chisel without interfering with its freedom of traverse; and advisable, as the horizontal position of the tool and its keenness, make it unusually insidious in cutting.

In traversing the hemisphere with the chisel, the cut is commenced at *b* fig. 554, by a portion of the edge near to the acute angle; as the tool proceeds around the curve, the cut gradually transfers itself along the edge, until it is near the center of the blade at the end of the traverse, which terminates at about two thirds from *b* to *c*. The chisel is then turned over and swept around the remaining one third of the curve, the cut being commenced at the center, *c*, also by a portion of the edge near the acute angle, the contact then travelling along the edge in like manner. Each pair of cuts being made to overlap, with gradually diminished thickness of shaving so as to remove a uniform quantity from all around the curve. During the reduction of the surface with the chisel the mandrel is stopped an instant from time to time by the hand, to watch the effect on the band, which is continually narrowing, and as before, should diminish equally, remaining nearly parallel.

This condition serves as a test of the work done with the chisel, and can only result from the equality of the shavings removed from all around the curve; but the senses of touch and hearing, besides that of sight, which has been hitherto most relied on, now commence to assist in the guidance of the tool. The recurrence of loss of contact between the work and the tool, caused by the band twice in every revolution of the lathe, is both felt and audible as a succession of little blows dealt on the edge of the tool, every time it comes again into work after passing over the band. The sound and blow have more force when the band is wide and comparatively deep, than later, when narrow and disappearing; and when the band is considerably and unequally attenuated, inequality in sound and touch as the tool traverses the curve, sensibly point out those portions upon which it has not cut sufficiently. Where most appreciable, the tool is made to linger, while the effect ceasing at any part of the traverse, shows the cutting to be already in excess.

The band gradually diminishes under the chisel until it becomes the old circumferential line, or would be so, but from the irregularities inseparable from the use of the tool. The remaining black lead presents the appearance of a broken irregularly wide line; where broken, the chisel has already scraped below the surface of the circumference, and it was to provide for this, that the band was left a trifle larger than the finished diameter of the ball; the irregularities in width, show those places still requiring reduction, but which reduction must not be permitted to extend beyond them. So little is required, that the tool may be held by the right hand alone the left arresting the mandrel, to discover the exact place at which the correction is to be made. The forefinger of the right hand is placed on the face instead of at the side of the chisel, which is swept around the curve by the movements of both hands as before, just in contact with the work, but not cutting. Having previously observed the position of the little spot on the circumferential line, when it is thought that the tool has arrived about opposite, the left hand is withdrawn from the tool and placed on the pulley, stopping the lathe mandrel for an instant, to observe the contact of the cutting edge. This, being where intended, the hand is removed from

the pulley and the shaving taken, the mandrel is then again stopped to see the effect, a further narrow shaving been taken, or the chisel passed on to the next point as necessary. The correction being continued, leaves the circumferential line much more broken, more regular in width, but not entirely obliterated.

The half of the ball $b c a$, fig. 554, may now be considered hemispherical; it is a little larger than the required size, and from it, the other half $b d a$, is next turned. A concentric line is first struck with a pencil, around the ball near the circumference $a b$; the ball is then withdrawn from the chuck fig. 554, and re-chucked having been rotated one half on the axis $a b$, fig. 556, the pencil line being adjusted to again run true. This line being true in every respect with the half of the ball already turned, when it again runs true, with the ball in the reversed position, fig. 556, it not only ensures the two halves being true with each other, but also by the truth of the aperture in the chuck, that all the adjustments of the circumference and axis requisite in producing the first half of the

Fig. 557.

Fig. 558.

Fig. 559.

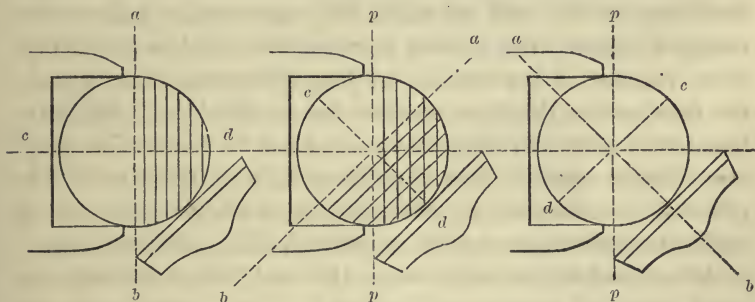

sphere, are at once acquired as a necessary consequence; and it only remains to turn the second hemisphere with the gouge and chisel, in the manner just followed for the first.

After this, the spot or spots are placed in the ball; a hole is bored by a small pipe bit to the depth of about one quarter of an inch, the nerve being usually selected for its position; the black wood plug turned to fit it, is driven in with a little cement and roughly cut off, it is finished to the surface in the subsequent turnings.

The two halves of the ball accurately turned as described should form a perfect sphere, but practically, minute errors exist all over them and the ball is still too large in diameter. The faults are gradually corrected in reducing the ball to size; in which process the chisel alone is used. The axis $a b$, having been always at right angles to the mandrel, the separate lines or circles cut by the tool, which collectively form the contour, $b c a d$, fig. 557, have been produced parallel with it. The small inaccuracies referred to are caused by these lines viewed separately and in section, being either too long or too short for the contour of the sphere; shown also by the irregularity of the circumferential line, when it was at length extracted from the band.

If the ball be made to revolve on some other axis than $c d$, another line will occupy the position of $a b$, and all the lines or circles then made by the traverse of the tool, will be parallel to this new line $p p$, fig. 558, and as before, at right angles to the mandrel; of necessity also they will cross at an angle the first set of circles, made while the ball was chucked as in figs. 554 to 557. The second set of circles will have their own errors; but these are materially less than those of the first, because the ball on which they are worked being more nearly a sphere, the correct traverse of the chisel is easier. The crossing of the second set largely corrects the errors of the first, and a third set worked from a third axis, will have less errors still, correcting the second set, the errors of which are already sensibly less than those left by the first. The process is continued, by chucking the ball upon axes at all angles to each other, until it is reduced to the required size.

At every change of axis, when the one half of the ball has been traversed by the tool, a pencil line is struck near the circumference $p p$, fig. 558, and the ball is then reversed and made to run true to this line, fig. 559. The second half is then in turn traversed by the tool, that the two may agree, or be on the same axis. One single equal shaving is removed all over each hemisphere at every chucking, and provided this be done, the more numerous the axes from which the ball is turned, the more accurately it will be corrected. The chisel however requires constant setting on the oilstone, that its edge may be straight and in the highest cutting perfection; while to

give the body steadiness for these fine finishing shavings, the operator removes his foot from the treadle, standing still on one or both feet, while guiding the tool around the ball. With the last vestiges of the band the tests of sight and sound disappear, and the guidance of the tool depends entirely upon touch, or the constant and equal contact between the tool and the ball. The nearly perfect form of the latter greatly assists the guidance of the chisel, but frequent practice is necessary to acquire and retain the delicacy of touch and freedom of hand, requisite for removing the thin finishing shavings quite equally from all around the sphere.

The turning should leave the ball so smooth and true a surface, as to require no glass paper, but this is sometimes used to a very limited extent, to obliterate any faint signs of the last traverses of the tool that might otherwise show through the polish. Glass papering is avoided as much as possible, as it easily deteriorates the truth of the sphere. The last marks left by the tool being in the direction shown by the lines fig. 557; the ball is withdrawn from the chuck, and replaced with the axis, *c d*, at right angles to the mandrel, so as to again cut across the direction of the lines. A piece of the finest glass paper, about three inches square, is held close around the ball in the hollow of the hand; it is passed around the curve from *b* to *d*, fig. 557, and to and from the operator simultaneously, being never allowed to rest in one place. The position of the ball is also frequently changed and reversed as for the turning, but the pencil line is no longer required.

The billiard ball is polished with washed whiting and water, page 1101. Vol. III. applied on linen rag several times folded; the position of the ball being still frequently changed that the abrasion in polishing, which is quite appreciable, may cross it in all directions to avoid deteriorating its truth. Washed clean from the whiting, it is dried and polished to a lustre with a few drops of oil, used in the same manner on some squares of soft rag; the balls are dyed in the manner and with the materials mentioned, page 577, previously to the final polishing with the oil.

SECTION III.—VARIOUS WORKS FORMED WITHIN THE SPHERE
BY PLAIN TURNING.

THE CHINESE BALL.

These works may be constructed either in wood or ivory, the latter being preferable from its uniformity of texture, which avoids some difficulties incidental to the former; all require an accurate sphere as the gage or foundation from which they are worked, and it is always supposed that this has been first produced. Some, require tools made to the size of the sphere in which the work is to be executed, or else, the sphere must be reduced to the diameter for which the tools are intended; while it is also a great advantage to the operator, to be himself capable of making and replacing the more delicate of the tools, some of which are rather easily broken.

The following examples, which will suffice to illustrate the different processes, may all be turned by hand without much difficulty. Many among them, together with some others still more elaborate, are ably described by Bergeron; but in setting out the platonic solids, rather easier expedients have been adopted, which are yet sufficiently good for the degree of accuracy that may be obtained by hand turning. The platonic solids, may be produced with comparative facility with the slide rest and apparatus for ornamental turning; but the description and manipulation of these, are foreign to the present volume. A complete and interesting series of these curious specimens of plain turning, may be seen in the collection of the Conservatoire des Arts et Métiers, Paris.

The popular ivory Chinese ball, made in the district of Canton, consists of several thin spherical shells, pierced with large holes, and contained one within the other, enclosing a small solid ball at the center. The shells are separated in the lathe with tools introduced through the holes, their surfaces being carved and ornamented subsequently, also through the holes, with appropriate small tools and drills. In the native specimens the turning is usually rather roughly executed, but the carving effectually hides all imperfections.

The Chinese ball shown in the section, fig. 560, has three

shells pierced with six holes, the centers for which, fig. 561, are first carefully set out upon the sphere, turned to the diameter A. B. The circumference C. D, is determined from the edge of the chuck and marked with a pencil line, in the manner described page 416 ; it is then divided into four equal parts by the division plate and marked across with short pencil lines. The edge of the rest, exactly at the height of center of the lathe being placed close against the ball, or in preference, one of the accurate scribing tools, being used in marking them. The centers for the remaining two holes, are upon the axis A. B ; one center is turned with a point tool at B, the ball is then reversed in the chuck, the line marking the circumference adjusted to again run true, and the other center at A, turned in like manner.

The plain wood chuck, that employed in turning the sphere, is now exchanged for another similar to that described by

Fig. 560.

Fig. 561.

Fig. 562.

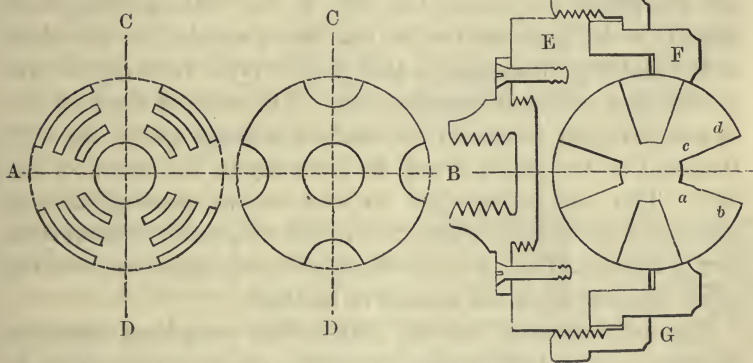

Bergeron, but with the addition of a metal flange screwing on the mandrel, fig. 562 ; it is formed of three parts shown in section. The back E, is of wood, hollowed exactly hemispherical to the diameter of the ball. The wooden ring F, hollowed within to the same curve, is carried on the back by a plain cylindrical fitting ; the two are closed upon each other by a metal ring, G, screwing upon E, thus grasping the ball, of which about one third is accessible by the aperture in the face of the wooden ring. The ball can be readily fixed with any point of its surface in the axis of the lathe, and remains

undisturbed when G. is tightened. The ball being placed in fig. 562, the four centers upon the circumference C. D., are successively adjusted to the center and struck with the point tool; previously to turning all the six radial holes, A. B. C. D. shown by the sections, figs. 560 and 562.

The inner ends of these apertures form portions of the surface of the solid central ball, and to render them all similar, they are fitted to a template fig. 567; the tools used being the drill, the right side, and a narrow flat tool for the bottom, or otherwise, a shallow hollow tool ground to the section of the central ball. It is more convenient to replace the template, by the taper halfround bit, fig. 563; the holes are then prepared with the hand tools and finished with the bit, which like the template, is prevented entering to too great a depth by two non-cutting projections that are arrested by the surface of the ball. The tools for separating the shells, figs. 566, 568., are analogous to inside parting tools, with the blades curved to the radii of the circles for which they are required. They are sharpened only upon the end, *a*, the cutting edge being slightly wider than the rest of the blade, which, like the blade of the inside parting tool, is also ground taper vertically to give it clearance within the grooves cut. The stem of the tool lies in a rectangular groove in the shaft of a metal guide, fig. 566, the front of the guide being filed exactly to the curve of the ball. The tool is attached by two screws passing through elongated holes, and is adjusted to the requisite depth within one of the radial holes in the work, with the entire curve of the guide bearing upon the surface of the ball.

The solid central ball, fig. 560, is first completely detached and then every shell seriatim, from the most central outwards. The sphere is placed in the chuck, fig. 562, with the radial aperture B in front, the grain therefore running in the direction of the axial line. The smallest tool placed in the guide, is then applied within the hole and adjusted and fixed, so that the corner of the blade *a*, just touches the surface of the central ball, *a c*, with the back of the stem close against the side of the radial hole *c d*, and the guide, in contact with the exterior surface. The tee of the hand rest is fixed just sufficiently high to place the surface of the tool both horizontal, and radial to the sphere. Thus arranged the tool is made to cut around the

curve of the ball in the direction B to D, until it is arrested, by the front of the stem arriving in contact with *a b*, or the opposite side of the radial hole.

The first cut completed, the brass ring is slackened, and the ball reversed with the fingers, is refixed with the aperture A running true in front; and the tool remaining fixed as before, is then used at this hole. The four holes upon the line C. D. are then successively adjusted to the front to run true, the tool gradually separating the central ball from the surrounding material by cutting at each hole, and setting it entirely free at

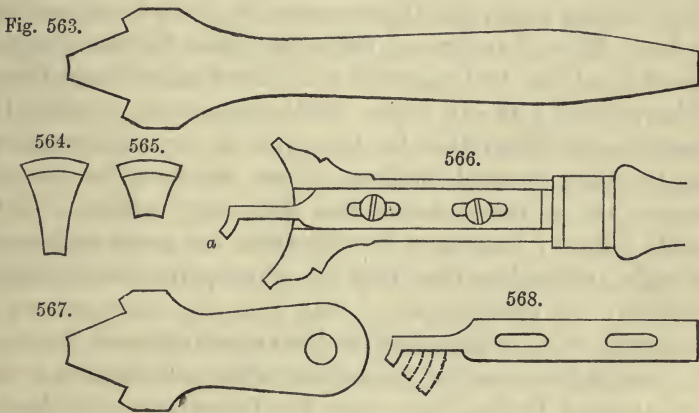

the termination of the sixth cut. The innermost shell is separated by the next larger tool, used in like manner from all six centers, followed by larger tools according to the number of the shells; the two first cuts being always made at B and A, fig. 560, or *across* the direction of the grain.

The path of the tool is completely under control, so long as the entire curve of the guide is retained in contact with the surface of the ball; but the cutting action, not only resembles that of the inside parting tool, previously referred to, but the liability to an accumulation of shavings arising from the enclosed position of the tool, is now also increased by its curved form. Increasing the width of the groove to give the shavings facility of escape, as with the inside parting tool, not being allowable, the tools require using with great gentleness and caution; and the formation of any hard collection of shavings

is carefully watched for and immediately reduced, to avoid the otherwise almost certain breakage of the tool or work. The tool also requires to be frequently withdrawn, to have its sides and cutting edge cleansed from adhering shavings, and its edge slightly set upon the oilstone, that it may cut freely and leave the surface of the shells smooth; as any surface roughness cannot be conveniently removed subsequently.

The diameter of the radial apertures depends upon their number and arrangement, but the smallest diameter that will suffice, produces the most effective result. The tool has to cut through rather more than half the material lying between neighbouring holes, and the diameter of the hole is required so much larger than this, as will allow space for the width of the stem of the tool in addition to the length of the blade. Balls pierced with six holes, which have been selected for simplicity of illustration for this, and the two following examples, show a radial diameter of one eighth of the circumference to be rather more than sufficient, while one ninth barely suffices; but, when the apertures are more numerous, as eight, or twelve, they may be of proportionately smaller diameter. In making a set of balls from the six apertures as described, it is obvious, that the least accessible and therefore the most difficult part of the turning upon each shell, is at the last, and lies at the point where the three circles cut by the end of the tool intersect. The difficulty experienced in cutting this portion of the work, may however if necessary be considerably reduced, by boring smaller additional conical apertures at these points of intersection, to remove a portion of the material. This expedient also allows of a small reduction in the length of the blade of the separating tool, with a corresponding reduction in the diameter of the original six apertures; and may be considered to improve the appearance of the result. The additional apertures have been omitted from figs. 560. 562. to avoid confusion.

The edges of the holes in the shells may be left square, or turned to a bead or moulding with an internal tool, fig. 401; a bead or other narrow ornament may also be cut around them on the surface of the shell with ordinary tools, intro-

duced at a considerable angle to A. B. Such enrichments are turned concurrently with the separation of the shells; the dividing tool is allowed to cut a short distance and withdrawn, the moulding is then cut upon the edge while the shell is still solidly attached to the surrounding material, and the separation is then resumed.

The intervals or surfaces between the apertures upon all the different shells, may also be covered with ornament formed of circles, small hemispheres, beads and cones, turned upon them, and by small pierced holes; all admitting of arrangement in groups or patterns. Every interval is brought successively to the aperture at B, and temporarily fixed by a conical wood stopper, inserted in the opposite aperture at A. The head of the stopper fits the hole in the external shell, its outer surface being turned to the curve of the ball. The stopper fig. 564, is sufficiently long to reach the central ball, and to press it and the entire contents of the external shell together against the side B; holding them with sufficient firmness for the shallow turning required in producing the ornament. The shells further from the center, may be held by corresponding stoppers of less length.

The pattern is first sketched out upon the surface with a pencil, every center is then adjusted fairly to the mandrel axis, seriatim; the outer shells by the fingers, and the innermost by aid of a sharp steel point; the screw ring of the chuck being slackened previously to every change of position, to lessen the pressure of the stopper; the enrichments are easily executed and may be very elaborate, but they then require both time and patience.

SOLIDS TURNED WITHIN THE SPHERE.

Hollow balls containing compound solids formed of cones or rays, and other shapes attached by their bases, are produced in much the same manner as the Chinese ball, but with some additional precautions. The sections figs. 569. 570, give such a figure, formed of six acute cones attached to a cube, contained within a single spherical shell.

The solid sphere while in the plain chuck is marked with six equi-distant centers, as in the last example, it is then transferred to fig. 562, and radial recesses of the form shown

in section, at A. C and D, fig. 570, are turned at all the six centers. The recesses are about one eighth of the circumference of the ball in diameter, and are equal in depth to the thickness of the external spherical shell together with the width of the blade of the separating tool; a projection being left at their centers, to form the extreme points of the cones. The cones are then turned to shape, and a portion of the external

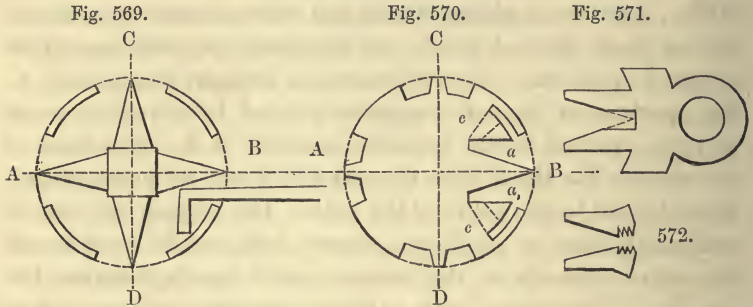

shell separated from its contents, at every center, seriatim; the first being turned at B, and the second at A, with the grain of the material running in the direction of A B.

The horizontal groove *a a*, is cut into the solid ball with narrow flat, right and left side tools, to a depth determined by a gage or turning square; the inner side roughly forming the angle of the cone, all of which is left too large or unfinished. The spherical groove separating the shell, is then commenced with a small tool, the width of the stem and the blade of which, does not exceed the distance between the rough point of the cone and the edge of the radial recess; the tool being used in the guide, fig. 566. When this tool has cut to its full extent, or to the first dotted line in the direction B to D, it is exchanged for one of the *inside* hand tools, figs. 579—581, then used to widen the groove *a a*, and to turn away *c c*, the material surrounding it. These tools are similar to inside parting tools, sharpened upon the ends and upon both sides of their blades, they are used in ordinary handles, and require care to avoid damage either to the cone or spherical shell. The corner of *c*, being turned away to the first dotted lines, allows space to introduce a longer separating tool, to continue the circular groove so far as the second dotted line; after

which, *c* is next turned away to the same distance with a longer inside tool, applied as in fig. 569. Sufficient space being thus obtained for the manipulation of the tools, the face of the cube is turned flat, and the cone finished to the gage of a thin metal template, fig. 571; the rest being placed rather high, that the left side tools used may be *slightly* inclined to the axis of the cone.

The first of a series of five conical wood stoppers, shown in section fig. 572, the exact counterpart of the radial aperture in the shell and of the cone, and abutting against the face of the cube, is then made, and placed in the work to support the internal solid figure while turning the remaining cones. The stoppers are pierced cylindrically to avoid damage to the points of the cones, and are cut with internal screws for the insertion of a handle by which they are subsequently withdrawn. Their external surfaces are turned to agree with that of the ball with a flat tool on the armrest, or they may be finished exactly with a narrow round tool, fig. 573, used in a metal guide having two projections bearing upon the surface of the sphere.

The ball is then reversed in the chuck and the foregoing repeated at A, and subsequently, at the four centers upon the line C. D. These latter require very careful and gentle turning with sharp tools, as the grain is then across the axis of the cones, while the tools also cut into the sides of the stoppers, inserted at A and B. When the last cone is completed, the five stoppers are withdrawn, in the reverse order to which they have been inserted, the last pair at A. B being both loosened before either is removed. The ball and star is frequently employed to form a portion of the stem of some other work, the parts of which are attached to opposite apertures, and are pierced with holes to receive two of the rays, to hold the points also in position. The effect of the specimen is enhanced when the solid is formed of eight or twelve points; the centers for these are set out on the sphere, as for the geometrical solids, the apertures are less in diameter, but the manipulation is otherwise the same.

The ivory balls sold in the bazaars of Singapore, fig. 574, have numerous small loose cones or points retained in cavities upon the surface; they are very similar to an ornament made

by the Chinese in porcelain, and both are supposed to be derived from the formation of the lotus-nut. On rotation of the balls the points as they arrive at the under side fall outwards to their full length, while those towards and upon the upper surface, drop back into, and are nearly concealed within their cavities, the points alone standing just above the surface. The little points number from twenty-five in the smallest, to sixty or more in the larger specimens, and it is affirmed that they are cut from the solid material of the ball. This is incorrect, but the deception is excellent, the Singapore balls

Fig. 573.

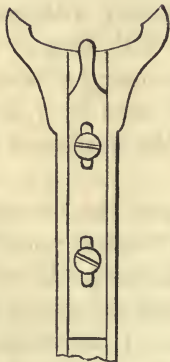

Fig. 574.

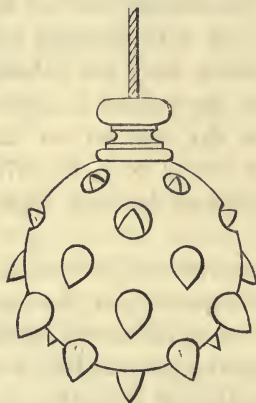
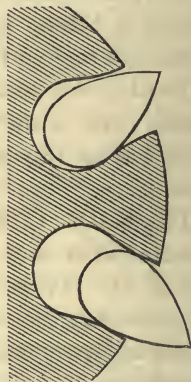

Fig. 575.



being turned in white ivory having little visible grain; a close inspection, however, shows that the grain of all the points coincides with their axes.

The points are difficult to extract, but if one be forced out, it, and its radial receptacle, are found to have the sections, fig. 575. The cavities are rounded and undercut, while the largest diameter of the cone, above its rounded base, tightly fits the orifice of the cavity and requires some force to make it enter. This ball has been alluded to, as being to some extent the reverse of the last described; it can be easily copied, taking care that the ivory used matches in colour and quality and has little grain, its manufacture requires no special instructions.

The method of turning simple or circular solids within a spherical shell, is described in forming the box, fig. 584. The solid sphere marked with six centers, as previously, is placed in the chuck fig. 562, and radial recesses rather larger than one eighth of the circumference of the ball in diameter, and equal in depth to the thickness of the external shell and the width of the separating tool, are turned at all the six centers ; as at A. C. and D. in the section, fig. 576. The ball is then adjusted in the chuck with the grain running in the direction A. B ; and the spherical groove separating the external shell s commenced with a tool in the guide, fig. 566, and carried

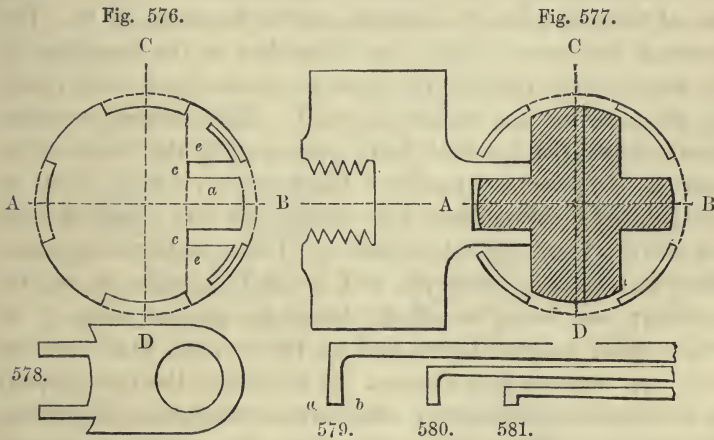

more than half way from the opening at B, towards those on the line C. D. The pin, *a*, required for chucking the interior when turning the box, is next formed by cutting the cylindrical groove *c c*, with ordinary narrow flat and side tools, to the depth of the dotted line ; the bottom of the groove is left flat, and the pin, *a*, very slightly taper to the size and depth of a template, fig. 578. The material *e e*, surrounding the pin, is next turned away also to the depth of the dotted line, with the inside tools figs. 579—581. The smallest tool widens the groove *c c*, giving space to insert and use the second ; the spherical groove is then continued to the apertures D. C, and the remaining material at *e*, turned away with larger inside tools, introduced with care, to avoid cutting into the pin or the partially completed spherical shell. The ball is

then reversed in the chuck and the preceding repeated, forming a second pin at A. The four recesses upon the line C. D, are then successively place central, to complete the spherical shell, with fig. 566; the last of the four cuts separating it from the interior, as in the section fig. 577.

The contained piece for the box, is then chucked in a hollow wood arbor chuck, fig. 577, and is held alternately by the one or the other pin, as the base or the cover may be under operation. The arbor is hollowed to a corresponding taper and to a depth rather exceeding the length of the pins, that its flat annular surface may be in contact with the surfaces of the work. Its external length is sufficient to permit the shell a small lateral traverse upon its contents, in the direction A, B. The external diameter is rather less than that of the apertures in the shell, which permits the arbor to revolve, and carry round the piece for the box within the shell. The latter is prevented from revolving and is held fairly quiescent, by the shafts of the hand turning tools, introduced through the openings both on the axis and circumference in turning the box; and also, by the left forefinger placed beneath it. Other methods are sometimes employed to retain the ball or shell quiescent during the turning; one being to attach strings to opposite sides of the shell, small weights being tied to the strings, which are led away over surrounding objects. In every case the tools require to be frequently withdrawn, that any accumulation of shavings between the shell and the box may from time to time be cleared away.

The under and upper external surfaces of the box are turned flat and convex, with tools analogous to fig. 580, introduced through the apertures of B and A, or, when the spherical envelope admits of sufficient traverse in the direction A to B, with these, and with a narrow right side tool, introduced through the apertures on the line C. D; after which the box is divided into two portions with a parting tool. The base and the cover are then successively chucked upon the arbor chuck, and are hollowed with fig. 580, introduced through C. D; the correctness of the internal surfaces being tested with gages of the form, fig. 583, or, a finishing tool may be made of that form with non-cutting portions bearing upon the edges of the cavities. The lip and the external edges are then turned with

ordinary small flat, bead, round or other tools, also introduced through the apertures upon C. D; and, when the work is in ivory, the internal surfaces are polished at this stage, with whiting and water upon a linen rag, applied through the holes by the finger. Each half of the box during the turning or the polishing of the opposite piece, being alternately held back in the shell and prevented from contact with the tool or rubber, by two narrow ribbons passed through opposite holes, and tied externally at B. fig. 582.

The fitting between the box and its cover must be sufficiently secure to hold the two halves together while turning away the

Fig. 582.

Fig. 583.

Fig. 584.

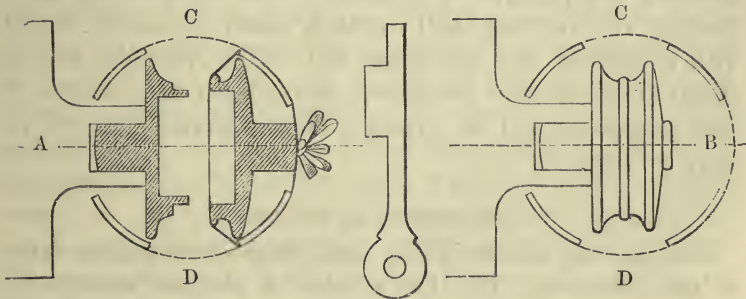

two pins, and yet slack enough, to permit of their easy separation and replacement by the tips of the fingers through the apertures when the work is completed. The fitting therefore is made sufficiently slack for the latter purpose, and strips of paper or ribbon are shut in between the top and the base, to give them a temporary hold secure enough for the former. The pin upon the cover, is cut off near to the convex surface with a parting tool, through D, and the portion remaining is turned through the aperture B, to a flat plate or other form, having an edge standing above the surface, fig. 584; this and the completed external surface of the cover are then polished. The pin on the base of the box is removed last, the hollow arbor chuck is exchanged for a similar solid arbor chuck, turned at the end with a recess exactly fitting the surface and edge of the central plate last turned upon the cover. The recess in the chuck and the central plate on the cover, are fixed to each

other with a little thin glue, when upon the lathe, and the box is immediately adjusted to run true; turner's cement being used instead of glue, when the ball and box are turned in wood.

The pin on the base, now standing in the direction of B, fig. 584, may be also cut off with a parting tool, but with care to avoid any sudden jerk which might detach the cover from its slender chucking. Or, it may be turned away entirely in shavings from the end, with a flat tool at B; which tool is required in either case, to finish the under surface of the base, previously to its being polished. The end of the solid arbor chuck is then cut off with a parting tool close to the cover, the thin disc of wood and the glue left upon the cover, being loosened and removed by moisture. The edges of the apertures in the external shell and their intervals, may be turned with mouldings and ornaments, and the box may also be enclosed in two or more envelopes; in the latter case, the box is first completed, and its envelope then separated into two or more as required.

GEOMETRICAL SOLIDS.

The majority of these forms admit of production in the lathe by plain turning. The five regular or platonic solids, contained by the surface of the sphere, so named from their possessing equal faces, sides and angles and from their intimate angular relations to each other, are offered as examples. Their construction from prisms, readily attained in the saw machine, together with that of other forms met with in crystallography, has been given in extenso, in the second volume; their construction in the lathe by plain turning, also allows them to be used as envelopes for other forms or for lesser copies of themselves, like the sphere in the late examples. Little special apparatus is required, but therefore the more exact manipulation.

The measurements upon the surface of the sphere, for the 4. 6. 8. 12 and 20 centers for turning the faces of the *tetrahedron*, *hexahedron*, *octahedron*, *dodecahedron*, and *icosahedron* respectively, are determined from the axis of the mandrel, and from the circumference whose plane passes through the center of the sphere, at right angles to that axis. On every

sphere which it is intended to convert into a regular solid, such a circumference is first traced in pencil, with a view to its division as may be required, by the division plate, and for obtaining the other measurements. It is also assumed that in every case a circle is described on paper, with radius equal to that of the sphere about to be treated; two diameters, A. B. representing the axis, and C. D. the plane of the circumference just mentioned, being drawn in the circle at right angles to one another.

For the tetrahedron or pyramid of three sides, the point *e*, is marked at $19\frac{1}{2}$ degrees* from C, fig. 585. the line *ef*, drawn parallel to the circumference C. D. and the figure completed; the centers for three faces are upon the line *ef*, and that of the remaining face at B. in the mandrel axis. To set out these four centers upon the work, the sphere is placed in the plain chuck with the grain running in the direction A. B., the circumference C. D. is found from the edge of the chuck, as previously described, and accurately marked with a pencil line; a center is then turned with a point tool at B, and the sphere reversed in the chuck with C. D. again running true. The distance *e*, C. as given by the drawing, is marked on the sphere, the circle *ef*, is struck upon it with a pencil line, and this circle is divided into three equal parts by the division plate.

The sphere is then chucked in fig. 562, with B. central, in order that the first face may be turned across the grain; and the material of the sphere is next reduced to the face of the figure with ordinary hand turning tools, but leaving a cylindrical pin at the center B. The height of this pin is first measured from the drawing, rather within its length and fixed on a turning square, which serves for the first rough turning. The exact height, taken from the drawing, the diameter of the pin as left by the tool, and the curve at the end, part of the original surface of the sphere, are then carefully cut out as a notch in a thin sheet metal template, similar to fig. 578, but with the two parallel sides left considerably wider, and flat and true as to their ends; this second gage serving when completing the turning, that in every case the sufficient, and exactly similar

* Mathematically $19^{\circ} 28' 17''$.

quantity, may be subsequently ascertained in like manner, in turning every face to the depth and to a true plane. The face surrounding the pin at B. is turned flat under the guidance of a steel straight edge laid across it; after which, the material just turned away is replaced by a hardwood filling piece, indicated in section by the shaded part, fig. 586. Which precautions are requisite, for the adjustment and security of the work in the chuck when turning the remaining faces, and also to prevent the tool during their formation, from splintering the edges of those already completed. The filling piece being turned flat and fitted to the pin, its exterior is turned, in its place or separately, to the exact radius of the sphere; the

Fig. 585.

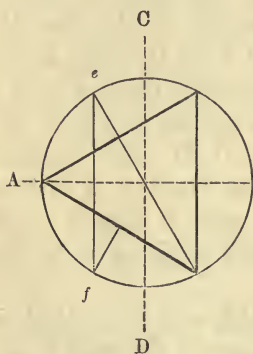

Fig. 586.

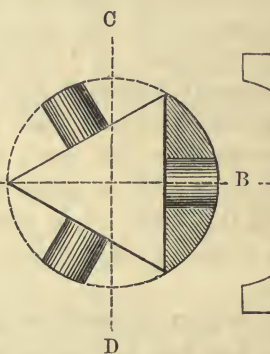
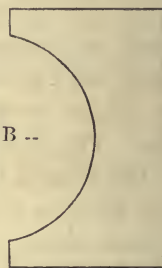

Fig. 587.



curve being obtained from a thin template, fig. 587, previously turned to the exact diameter. It is then detached from the sphere, that the central pin at B may be cut off, and the space it occupied made co-incident with the surface, which, when uniform is polished. The filling piece is then re-attached to the completed face by thin glue or cement, and the work replaced in the chuck, with the center which has been marked for one of the remaining faces, revolving truly in the mandrel axis, in the position lately occupied by B. Should the solid be turned in ivory, the wooden filling pieces may be attached directly to its surfaces, as the ivory may be subsequently immersed in water for their separation; but when turned in wood, a piece of thin paper is interposed between the slightly

glued surfaces, that they may be afterwards detached without damage.

The second face of fig. 586, is treated precisely as the first, but as its grain is nearly lengthwise, and as it meets and cuts the first at an acute angle, forming the straight line common to the two faces, the management of the turning tools requires increased care to avoid accident, particularly to the extreme corners of the first face, which are but slightly supported by the filling piece. The third face turned in the same manner, meets and forms edges with both the first and second, and the fourth face with all the three preceding; this last terminates

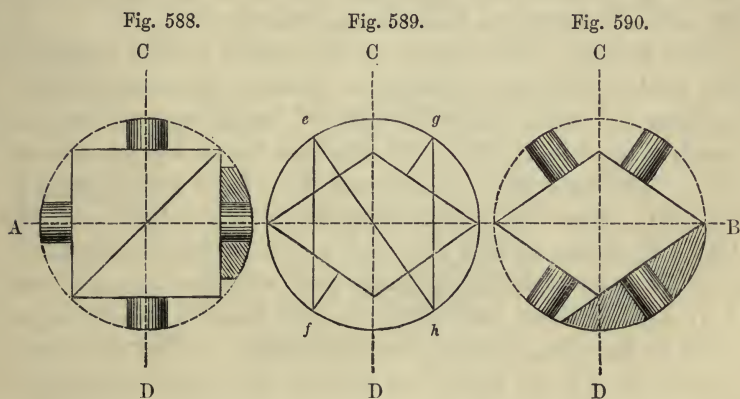

the figure and requires no filling piece, the pin turned upon it serving only to measure the depth from the surface.

The hexahedron or cube fig. 588, has two of its centers in the axial line A. B, and the others upon the circumference C. D, divided into four by the division plate. The cube may be turned from the sphere after the same manner, but the filling pieces are only required to hold the work in the chuck, after the removal of the pins, and may be made as rings shaped on the outer surface to the curve of the sphere. The rectangular form of the solid affords the edges of the faces complete support, and they do not splinter, provided the two faces across the grain at A. and B. are turned first. The cube for ordinary ornamental purposes may be turned by several different methods of chucking, some of which are referred to in the last chapter

The octahedron or double four sided pyramid, figs. 589. 590, has four of its centers upon the lines ef , and four upon gh ; the positions for these circles upon either side of the circumference, being determined by the line eh , at $35\frac{1}{4}$ degrees* to C. D, first drawn on paper as before. One of these circles gh , having been marked on the ball with pencil, it, and the circumference C. D, are divided into four by the division plate; the sphere is then reversed in the plain chuck and the other circle ef , marked and divided into four, the index being adjusted that the four marks may exactly agree with those on C. D, that thus every pair of centers may be exactly opposite each other upon the same four lines. The filling pieces, fig. 590, are similar to those already described.

The division of the surface of the sphere for the centers of the twelve equilateral pentagons forming the dodecahedron, perhaps the most beautiful solid of the group, is also that which is most useful for other spherical works and ornamentation. The form and arrangement of its faces are indicated in fig. 591. The circle, the diameter of the sphere, and the line eh , drawn at $26\frac{1}{2}$ degrees† to the circumference C. D, give the distance for marking the work with two circles ef , and gh ; each of these two circles is then divided into five equal parts by the division plate, but alternately; so that the points marked on the one circle, are opposite the spaces and exactly between the marks on the other, this places ten centers, the remaining two being at A. and B. in the axial line, and as in the previous examples the end way of the grain.

The centers of the twenty equilateral triangles of the icosahedron, fig. 592, lie in pairs, alternately upon the circles ab , cd , and ef , gh ; found by the lines ah , and cf , respectively at $52\frac{1}{2}$ degrees‡ and $10\frac{3}{4}$ degrees§ to C. D, by the division of all those circles into five equal parts. The circles ab , and cd , being divided alike, and the circles ef , and gh , being also divided alike; but the points of division on the two former circles being intermediate to those in the two latter. The manipulation in turning these solids is in every respect that already described, but the increased number,

* Mathematically $35^{\circ} 15' 52''$.

† Mathematically $52^{\circ} 37' 21''$.

‡ Mathematically $26^{\circ} 33' 54''$.

§ Mathematically $10^{\circ} 48' 44''$.

requires greater care in marking and adjusting the centers to run true, to ensure that all the faces are true planes, that they are all reduced to a precisely similar depth from the surface of the sphere, and that all the solid angles are left perfect.

The separation of the solid polyhedra into several shells, contained one within the other, is accomplished much after the same manner as with the chinese ball, but with straight in place of curved tools and guide. Every external face at its completion upon the sphere, and before proceeding to form the next, is pierced with a radial aperture flat at the bottom, pro-

Fig. 591.

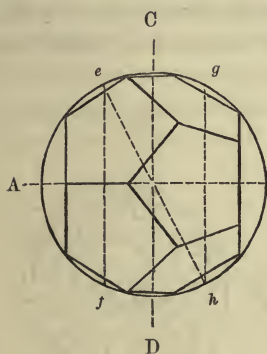

Fig. 592.

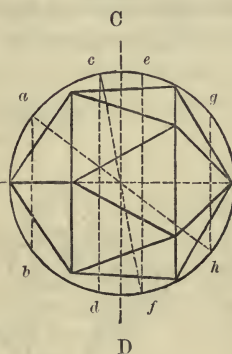

Fig. 593.



portioned in depth to the number of shells and their intervals, or the widths of the separating tools, and in diameter, to the length of the blades and the breadth of material to be severed. The exact form requisite may be previously set out on paper and a template made to it, similar to fig. 567, that all the apertures in the different faces may be turned to one size. As every aperture is made, it is fitted with a stopper, fig. 593, bearing upon the bottom of the hole, which will be one face of the central solid; the head, turned to the curve of the sphere to serve as the filling piece, and cut with an internal screw to insert a handle to assist its removal.

The separating tools are used in a guide similar to fig. 566, but with the front, which bears upon the flat faces of the solid, straight and parallel with the blade of the tool. The face of the central solid is first separated and then the shells, from the most central outwards, after which the stopper is inserted in

its place; this is retained in position by fitting the aperture, but requires securing, by slightly cementing under its head. The other faces are then proceeded with in the same manner, but, as every one becomes inaccessible, so soon as its stopper is inserted, the similarity of depth to which the different separating tools are placed from the surface, requires great care. Accuracy in this respect is however readily attained, by employing a distinct tool and guide for every shell; these tools remaining fixed in their guides, as they were set for turning the different faces at the first aperture. It should be observed that the exterior faces and angles of each shell, are copies of the external solid, but that their internal surfaces are not entirely so, for the superficies of the separating grooves being circular, they cannot quite approach the internal angloids; as

Fig. 594.

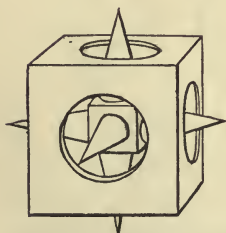

Fig. 595.

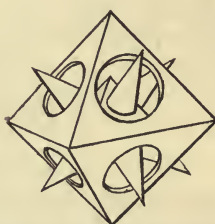
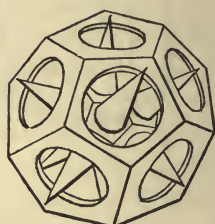

Fig. 596.



these however are not visible, this is comparatively unimportant. For the same reason the complete separation of the shells, requires a tool of greater proportionate *width*, than with the chinese ball; that the corner *a*, fig. 579, may quite complete the external faces of the more central shell, without *b*, cutting through those in the shell exterior to it.

The methods of turning simple or compound solids with polyhedral envelopes, may be sufficiently gathered from preceding pages. In one instance, the compound solid turned within the sphere, fig. 569, is precisely the same turned within the cube, fig. 594; while figures of similar or different character may be produced within all the other regular solids, provided the number of points or other forms, corresponds either to that of the faces or the angloids of the solids. The central pins,

employed to determine the depth of the faces, in figures 594—596, usually remain to form the apex of the cones, which are turned to a gage similar to fig. 571, and project beyond the faces of the external solid.

The production of one face, pin and cone, and hollowing the corresponding portion of the shell, may be concurrent and completed at all the faces, seriatim; or, all the faces and pins may be first produced, and then returned to in regular order to turn every cone, and to hollow its portion of the shell. The combined filling pieces and stoppers, fig. 593, required as the points and faces are completed, are fitted to the apertures in the shell, pierced and exactly fitted to the cones, abutting against their base the central solid; affording support in the same manner as for the sphere, fig. 569. The edges of the apertures may be enriched by ornament, and the internal solid may also be contained within two or more shells, separated from one thicker envelope.

CHAPTER XII.

PRACTICAL EXAMPLES OF SIMPLE, PLAIN TURNING IN
WOOD AND IVORY.

SECTION I.—CONSTRUCTION, FORM AND ORNAMENT.

PLAIN turning in wood and ivory has so wide a range, that illustration by examples can necessarily indicate but few of its results. The indulgence of the reader is therefore claimed for the attempt made in the following chapters, as also for the short preceding references to construction and design ; which, serviceable to beginners, must in many points be already appreciated by the practised amateur. The series of typical designs offered, presents no difficulties, but gradually increasing elaboration in form and manipulation ; and it is hoped may also serve as suggestions, to be carried out in other shapes as individual taste may determine.

In simple plain turning, the work revolves and is entirely executed upon one axis. The specimen may be produced from a single piece of material, or it may be constructed of many pieces, perhaps of several contrasting materials, all its parts still possessing one common axis or center ; the entire work may be of the plainest character, or it may be distinguished by elegance of form, or enriched by ornament. Combined plain turning, to which the succeeding chapter is devoted, may be divided into specimens formed by a central principal and axial figure, into which turned ornaments or subordinate parts are inserted eccentrically ; and into those in which the solid itself is turned from two or more axes, for the production of surfaces, ornaments or projections at various angles to the main axis.

The combination of many pieces in simple plain turning is frequent and necessary ; for economy of material, convenience in construction and manipulation, for strength, and for contrast in color. Small and moderate sized works, when no contrary reason exists, are however often advantageously made from a single piece as one solid ; but when the work presents

any considerable variations in diameter, and is of large or even moderate size, it is generally necessary to construct it of two or more pieces fitted one into the other or screwed together, as will be shown.

All the above mentioned reasons it may be said, have about equal force in determining whether the entire work should be turned in one or in several portions; and if in the latter, as to whether its main subdivisions should themselves be constructed of one or more pieces. The increase in stability attained by chucking the work as several short lengths instead of in one long piece, greatly conduces to the production of smooth and well finished surfaces. Separation into parts, generally permits greater freedom in the management of the tools, which otherwise often have to be restrained and are with difficulty prevented from encroaching upon neighbouring portions of the work; while the short lengths of the individual pieces very frequently enable the popit head to be dispensed with. In forms, such as figs. 633. 663, and others, where portions of the work of comparatively large are connected by those of small diameter, the neck or connecting piece when turned from the solid is more or less deteriorated and weakened by the strain it suffers in the process; diminished diameters in such positions are therefore much stronger, when turned upon one only of the two large diameters and attached in an aperture turned in the other; or sometimes, the smaller portion may be turned as a separate piece to be affixed to both its neighbours. Lastly the comparative rarity of hardwood and ivory of the larger diameters, makes it desirable to economise these by employing portions of no greater length than is essential to the design.

It should also be remarked, that some among the following subjects are relatively of large and others of small size, this circumstance, together with the limited space at disposal, does not allow of the entire series being drawn to the same scale; but as every figure exhibits its due proportions, the variation may perhaps be considered as of less importance. All are taken from a tabulated list, placed at the end of this section, possibly convenient as a collection of works of utility or ornament produced in the lathe; most possess the former characteristic, and while it is premised that all are intended to elucidate modes of procedure, rather than to serve as models

of form, it is hoped that none may offend good taste. While, without assuming to lay down canons on so inexhaustible a subject, this chapter can hardly be passed over without using the same examples, in hazarding a few words upon form and ornament and their appropriate application in plain turning.

In the production of any specimen marked by good taste, the elements of success are found to lie in the adoption of simple proportions in the section or outline of the main figure; followed by a co-relation to this form in the details of a subordinate ornamentation; which together, give a homogeneous, natural character to the design. In turning however, the outline is often and correctly influenced by the appropriateness of the form to the purpose to which the work is to be applied; and secondly, the proportions that appear most desirable may have to submit to variation, to be more or less recast, by reason of imperfections or of want of sufficient size in the material, either of which may only become apparent during the progress of the work. The former of these contingencies need but rarely interfere with an agreeable shape; and the latter may be overcome, in the infinite gradations that may be given to the principal curves forming the outline, which in almost every case will submit to variation in depth or curvature, height or breadth, and still remain elegant. A convenient property, in great measure neutralizing any ill effect the accidents of the material might otherwise exercise over beauty of form, and affording scope for ingenuity and taste, to satisfactorily vary the original proportions of the design.

Correct balance or proportion between the principal curvatures of the outline, differing as it does with every individual figure, cannot be easily defined, but inappropriate form and the class of error to be avoided may be broadly indicated. Thus, it is evident that the graceful, tapering curve of an amphora, employed in fig. 700, or the outlines of any of the vases, figs. 670 to 678, would be destroyed by the superposition of secondary, quicker and abrupt curves, merging into the first at any part of their length; but on the other hand, such curves becomes appropriate as part of the bowl of a chalice or tazza. The lower portions of any form it is equally apparent should be of sufficient magnitude to convey a feeling of stability, and yet not so extended as to appear unduly heavy; while cornices and other projections towards the summit,

poor and feeble, when too slight in depth or width, become in most cases equally ungraceful when too far extended in proportion to the foot or to the body of the work from which they spring. On the other hand, many among the illustrations exhibit the extent to which the curvature of the main outline may sometimes rapidly taper from a large to a small diameter, without giving the effect of weakness, and others, that to which lips and similar projections may occasionally extend. Artistic feeling demands a balance in the form of every figure, but so arbitrary are the curvatures that may be successfully adopted that the elegance or otherwise of the outline produced, must always in great measure depend upon the taste and knowledge of the operator; with results more successful from one hand than another in corresponding degree.

Subordinate to the principal outline there follows the prolific subject of suitable ornamentation; which in plain turning, takes the form of fillets, mouldings and small curves, separated by cylindrical and other plain portions. The success of these ornaments depends upon the correct form and relative proportions of their members, a suitable variety or contrast, or when similar mouldings are employed in different positions, variety in their dimensions, with the same view, and the employment of a sufficient quantity without profusion. While it should also be observed that these enrichments, the main curves and other portions of the outline, all require to be finished to smooth regular lines without any break, flat, or indentation in their length; but these faults, technically called "elbows," may always be avoided in turning, in which the uninterrupted continuity of the lines is easily obtained.

These qualities being less abstract than excellence in outline, lie more nearly under rule. Perhaps no such common fault is met with in turned works as that of a redundancy of ornament, which is as objectionable as ill shaped and meaningless form in the ornament itself. The juxtaposition of several complete mouldings with the view of adding to the enrichment, is to be deprecated and offends by transgressing simplicity; for, whether individually good or bad in form, too closely approached, each moulding will to a great extent interfere with the effect of its neighbour, the result of the entire group being confused and disagreeable. The best effect is produced when the mouldings are sufficiently separated by cylindrical or other plain portions

of the work, and the balance to be observed between these latter and those enriched by ornament, while again somewhat a question for individual taste, should be specially insisted on as of no slight importance to effect; the plain portions of the work giving greater force and value to the enrichments, while nothing can be æsthetically worse or more wasteful, than to conceal a beautiful form by excess of ornament. In the illustrations which follow, the plain portions largely preponderate, and although additional ornament might be employed in some instances, it would be at a corresponding sacrifice of simple to more florid style.

A pedestal turned to accord with some of the architectural orders, or a column approaching the same rules, may serve to illustrate these and some other points. In both, the proportion left plain is large, the mouldings at either end terminate the straight plain shafts, to which their figured projections give the requisite variety, and in the column, relieve what would otherwise be an abrupt junction of the shaft with neighbouring portions of the work. The upper mouldings forming the cornice or capital, as in the pedestals figs. 663. 707 and in the columns, figs. 708. 733, usually entirely differ from those at the base or plinth; while should similarly formed mouldings be employed in these two positions, they generally differ in magnitude to avoid monotony, figs. 730. 747; although, as none of these statements are without exceptions, in some analogous works, as in figs. 727. 731, the mouldings receive exact repetition at either end of the column. Mouldings in these relative positions, are usually correct in their individual proportions when the greatest diameter of that forming the base, stands either as the lowest member or nearly so, while in the capital or cornice this order is reversed; the two then gradually taper towards the shaft, figs. 707. 731 spreading as a foot below and a support above, their original purposes. Occasionally these proportions are reversed, the mouldings standing the other way uppermost with good effect, as in some Moorish and Egyptian columns, the forms of which are very well suited for reproduction in the lathe; but the effect of the transposition is usually less pleasing and rather abrupt, sometimes giving the appearance of want of strength.

The only recognised positions for the enrichments founded on the classic models being towards the two extremities, the

shaft may receive no further ornament, except in the case of the Doric column, which is sometimes rusticated. The shaft may then be said to be surrounded by quasi-cylindrical portions at regular intervals, all along its slightly tapering length, these additions having plain edges and being in width some four or five times that of their intervals; which latter, should be about as deep as wide. This nevertheless still preserves the same general outline, as the rusticated column may be otherwise described as having its shaft larger in diameter and cut into a series of rather shallow square grooves; a groove being next to both capital and base, which remain as before. In another variety cubical blocks replace the added cylindrical ornaments, the column then appears as if finished cylindrical only at regular intervals along an original square shaft, or as threaded through a series of cubes. These styles of ornamentation are easily produced in the lathe and may sometimes be carried still further, as in the mirror, fig. 733, by the alternation of cubes with beads or other forms.

A different taste has introduced or revived the employment of one considerable increase of diameter at the center of straight slender shafts, or of one principal and central increase with one or more subordinate, placed at equal distances above and below it; forms of ornament effectively employed in Church and other furniture, probably derived from the Lombardo-Romano school of architecture. The central piece is frequently turned from a different material and enriched with mouldings or inserted ornament by the method described, fig. 755; when it is of the same material but of largely increased diameter to the shaft, it is very often added in the form of a ring, the addition being concealed in the manner shown by fig. 763; thus producing a column of considerable effect with a minimum of material. Many other shafts and rods, especially those employed for balusters and portions of domestic furniture, have their lengths broken and ornamented by a greater or less number of beads and mouldings connecting their various curved or straight lines; while most of the plain or ornamented shafts referred to, may be readily grouped together in plain turning to form clustered columns, as described in figs. 721 to 726.

An additional use of ornament lies in its employment to break joint, that is, to conceal the junction of the pieces of

which any portion of the work is composed. For this purpose, the position for the joint is arranged so that one portion of the work that is turned to a plain edge, abuts against a moulding turned upon another, or, when the moulding is of bold proportions, some of its members may be turned upon each of the two pieces, when in either case the position of the joint is lost sight of. Want of sufficient length or diameter in the material, also sometimes renders a joint indispensable in a straight or curved portion of the work, in a position where the form requires the outline to be left plain, and where therefore the joint would be visible.

A joint in such a position may be fairly concealed, by means of a shallow bead or other ornament turned upon the edge of one piece, and only sufficiently deep to leave its most prominent member just level with the surface or outline of the work; which surface ornament, something like a level string course in architecture, causing little or no depression does not materially interfere with the outline. Incised ornament of this character is frequently employed when there is no joint, as in the Etruscan vases, figs. 670 to 678, when turned of small size and from single pieces of material. The lines indicated in these examples are the boundary lines of the colour on the surface of the originals, and are therefore appropriate even when the work is solid; but when it is of large size so as to require several pieces for its construction, the junctions would be made upon these lines of ornament, which then break or conceal the joint also.

Frequently a somewhat intermediate course is adopted, a band or moulding of inconsiderable height being turned to stand just above the plain curve; this, primarily serving to break joint, may also be rendered an effective ornament without greatly interfering with the outline. Thus the long curve of the amphora, referred to as deteriorated by the addition of any abruptly projecting curve, will when necessary submit to that of a thin band or fillet, the two edges of which may also be appropriately enriched with small and delicate mouldings. This expedient has been carried still further in the base of the candelabra, fig. 746; not however in this case to break joint, but to counteract the abrupt effect of the junction of the feet with the vase forming the center of the base.

The beauty of a long, well proportioned, uninterrupted

curve in the outline is indubitable, but the form, the height or diameter, necessary to the purpose of the work, may render a single curve undesirable; mouldings are then appropriately employed to divide it. In some forms approaching the cylindrical character, the same curve is repeated on either side of the moulding serving the last purpose, or to break joint; but in most forms, the moulding terminates one and then serves as the starting point for a different curve. The moulding usually

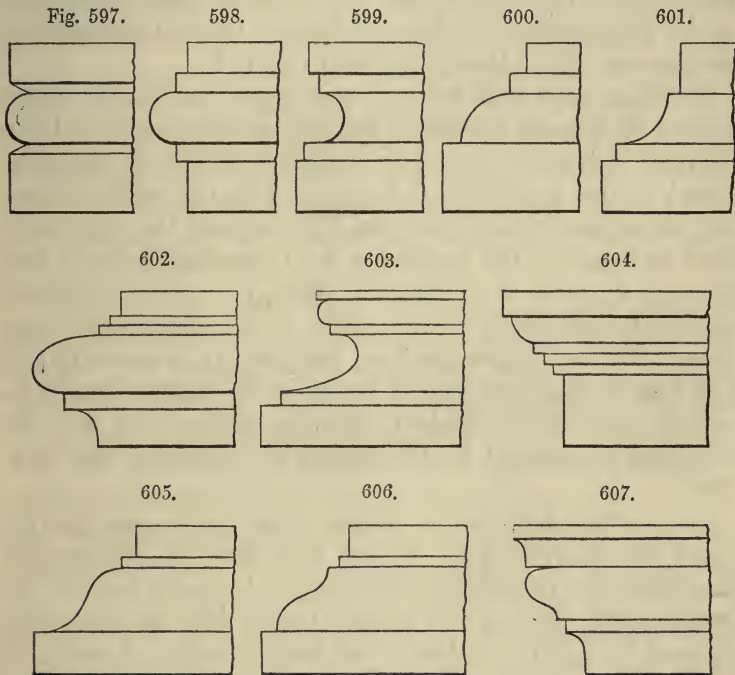

placed at the junction of a straight shaft with other portions of the work, such as the capital of the column referred to, becomes indispensable when a plain stem supports the body of a vase, or other work of globular or oviform section; the tapering moulding interposed then leads the larger to the smaller of these dis-similar forms, and avoids the disagreeable effect of an abrupt transition.

The character and proportions of the mouldings used and a suitable variety, the other points referred to, are again influenced by individual taste. Inelegance however, may easily

arise from too frequent repetition; from errors in the separate shapes, the hollows, rounds and other forms employed; from incorrectly grouping these as members of mouldings and from ill-judged position. Repetition of the same ornament, but differing in magnitude upon different portions of the work, will be met with in many of the examples, and this is correct and desirable as giving unity to the design; but on the other hand, if the repetition be too frequent the effect is monotonous. When many mouldings are necessary, relief is afforded by the introduction of others, sometimes themselves repeated, interspersed among those previously referred to.

Mouldings not intended as exact reproductions of classic models, allow some latitude in the relative proportions of their different members, but every member should be carefully turned to the exact form it is intended to represent. Thus, and enumerating those most used in turning, the *bead*, indicated by fig. 597, the *astragal*, a bead standing between two fillets fig. 598, and the reverse of these, the *cavetto* or hollow, fig. 599, lose in effect, when in place of the true semicircular section, they are represented by inaccurately rounded forms. The *quarter round* and *quarter hollow* in like manner should be exactly quadrants of circles; these as in figs. 600, 601, are frequently terminated by the surface or cylindrical face of a fillet.

The *ovolo*, employed in similar positions to the quarter round and its reverse or concave form figs. 602, 603, may be considered for explanation, as composed of one half of the quarter circle forming the quarter round, with the other half replaced by a curve of longer and flatter sweep. Actually it is formed by portions of ovals, being fairly represented by the last joint of the thumb viewed edgewise, whence it is popularly called the "thumb moulding." The relative proportions of the two parts of this continuous curve may be almost indefinitely varied, nearly always with satisfactory effect; prominent as in a cornice, or standing alone as in the lip of a vase, any requisite increase in width may be obtained by extending the longer portion of its curvature. The *ovolo* may be terminated by a fillet, or by a *quirk*, as in the ogee fig. 607. The combination of a round and hollow in one curve forming the *ogee*, may have the two halves corresponding in dimensions, or their relative magnitudes may be considerably varied; either

the convex or concave half may be placed above, the former ogee, fig. 605, being styled the *cyma-recta* and the latter the *cyma-reversa*.

The effective appearance of the *fillet*, depends upon the truth of the small portions of cylinder and surface of which it is composed, which then meet exactly at a right angle. The clear definition thus obtained for a single fillet, is essential to the success of the little steps formed by a series, fig. 604, a tapering ornament employed beneath a projecting moulding, or when reversed, upon a plinth. The fillet is sometimes replaced by a *quirk*, occasionally introduced to give vigour to the ogee or ovolo. In the quirk the narrow width of cylinder which would have formed the vertical face of the fillet, is cut *in* as an acute angular groove, square as a surface on the horizontal side and meeting the termination of the curve at a sharp angle on the other, fig. 607, leaving the latter unsupported, which throws the groove or quirk into shadow.

The grouping of the various members described into complete mouldings, admits rather wide variations, but in this respect it is perhaps safer to conform generally to acknowledged architectural models. All such mouldings owe their elegance to contrast and balance; a bead or round being followed by a hollow, these reversed forms being rarely of similar dimensions, while they are more generally separated and diversified by fillets, quirks, or plain portions of the cylinder or surface. Two similar members or forms are very rarely placed in juxtaposition, even when differing in magnitude; exceptions to this general rule, being the beads at the base of the Doric column, the series of fillets before alluded to, and the reed, an ornament formed of a series of narrow beads, generally of uneven number. The latter ornament forms a flat band standing above the surface of the work, and the little beads of which it is composed are usually all of the same diameter and width, but in some varieties the beads are alternately of different widths. In turning, the reed is more exactly formed when produced by a single moulding tool called a *barrel tool*, the cutting edge of which is serrated to the required form.

Lastly, the accurately shaped mouldings so entirely subordinated to the form as to leave that the main attraction, cease

to be superfluous, when so placed upon the work as to serve some direct purpose in addition to that of ornament. Thus for joining a larger to a smaller diameter at a base, or to support a cornice, or to connect the superstructure to its stem, to conceal a permanent joint, or to strengthen the edges of parts fitted or screwed together, which in subsequent use have to submit to frequent separation; the moulding is essential and its position obvious. When employed to break the monotony of long vertical lines upon shafts and other nearly parallel forms, except upon a pedestal, the moulding may be placed about the center of the length; but upon vertical curves and upon horizontal lines and curves, a more agreeable effect generally obtains by placing it rather decidedly above or below the center of the line to be divided; examples of all these purposes are given in the following illustrations.

The graceful, simple beauty of the ancient Greek and Etruscan vases, in great measure arises from the almost constant adherence to one principal curve, which, also admitting infinite fine gradations, was equally employed in the main outline and in the details of the enrichments. A few words may be permitted in analysis of the system, both as one that cannot be surpassed in results, and as particularly adapted to the production of good forms in the art of plain turning.

The beauty of the curve of the circle lies in its exact uniformity, that of the ellipse, neglecting its many gradations from a long to a more nearly round character of curve, both in uniformity and variety. The former yields the complete circle, the semi-circle, the quadrant and any portions less than the quadrant, all of which obviously possess one continuous curvature. The latter gives the ellipse, the semi-ellipse upon the long and that upon the short diameter, and any less portions taken anywhere around the curve; all of which, while still possessing relative uniformity, continuously vary in curvature. All sections or outlines contained by portions of the circle therefore, are similar in the character of their curvatures; but those contained by portions of the ellipse may be exceedingly varied, as the part of the curve used for the outline may be taken from the sides or the ends of the figure, as it may comprise parts of each in various relative degrees, and as it may be placed with its shorter or longer curvature uppermost. And

when the curve of the outline is returned, that is proceeds in an unbroken line from concave to convex, the relative variety of outline is still more largely in favour of the ellipse.

The oval differing from the ellipse, in having the curvature of one end of the figure of less diameter than the other, uniformity is so far diminished, as to exist only in the similar curves of each pair of its quadrants; but as a consequence, the variation of outline into which the oval will compose, is twice that, that may be obtained from the ellipse. In addition, for the purposes of ornamental form, the difference of magnitude of the two ends of the oval may always be diminished or increased without interfering with its character, thus introducing further variety in the curve and the outlines that may be obtained from it.

The relative degrees of elegance, apparent upon comparison of vases or other axial forms having outlines of these three complete curves, are yet more striking when the curves cease to be axial, or when only portions are used to give the outline of the main figure, and also when these portions are employed on a smaller scale for enrichments. The oval is the key note of both form and ornament in the Etruscan Vases, in which beautiful creations a semi-circular section in the outline is rare; the oviform vases, figs. 670 to 678, drawn from the antique, exhibit outlines entirely derived from the oval line, and it will be seen also that portions of the oval are freely adopted in the outlines of many other of the illustrations. The figures especially referred to, which slightly indicate the varieties of similar forms that may be derived from the endless gradations of curvature of which the oval line is susceptible; show in addition, how subordinate the necessity for ornament may become when the main outline is intrinsically excellent. The turner is sometimes tempted to endeavour to annul want of success in beauty and proportion of outline, by superabundance of ornament, the simple yet subtle character of the Etruscan vases, shows how much may be attained by making outline the chief consideration; which valuable lesson is placed also in the well known aphorism directed against the opposite extreme, that the effort should be only to ornament construction, and not to construct an ornament.

TABULAR VIEW

OF WORKS IN PLAIN TURNING IN WOOD AND IVORY.

DINING ROOM AND DOMESTIC.	Tables. Table candlesticks. Table ware. Tea caddys.	SMOKING ROOM.
Apple scoops. Ash trays.	DRAWING ROOM.	Amber mouthpieces. Ash trays. Cigar cases. Cigar cutters. Cigar stands. Cigar tubes. Cigarette cases. Cigarette moulds. Horn and ivory mouthpieces. Pipe bowls. Pipe stems. Pipe racks. Pipe stands. Spill pots. Table lights. Tobacco boxes. Tobacco jars.
Bellows boards. Bonbon boxes. Bottle cases. Bottle label rings. Bottle stands. Bowls. Bread plates. Brush handles. Butter moulds. Butter stands.	Banner screens. Bases for glass shades. Candelabra. Candle screens. Card baskets. Card racks. Card trays. Carte de visite frames. ditto on stands. Chalices. Chandeliers. China bowl stands. Clock cases. Cocoa nut vases. Coquilla nut vases. Cups.	WORK TABLE.
Candle dumps. Chimney candlesticks. Candle elevator stands.	Egg shells as vases. Etagères.	Bodkins and cases. Crochet needles. Embroidery frames. Emery cushions. Knitting ball holders. Linen markers. Needle cases. Netting meshes. Netting needles. Netting vices. Pin cushions. Purse moulds. Reels. Reel stands. Screw pincushion work holders. Silk winding machines. Spinning wheels. Stiletos. Tambour frames. Tattooing needles. Tape measures. Thimbles. Thimble cases. Wax holders. Winders. Work cases. Work boxes. Worsted ball cases.
Drinking cups. Dumb waiters.	Flower holders. Flower pot stands. Hanging lamp holders.	
Egg cups and stands. Egg glasses. Epergnes.	Jardinières.	
Finger plates.	Miniature frames.	
Hand candlesticks. Hat pegs.	Ostrich egg vases. Pagodas. Pedestals.	
Knife rests. Knobs for doors, drawers, windows, and sticks.	Pedestals for bronzes. Piano candlesticks. Picture frames. Pot-pourri jars.	
Lamp stands. Lemon squeezers. Liqueur frames.	Slender ornaments. Standard lamp stands. Stands for China cups. ditto for plates.	
Menu-holders. Mustard pots.	Table mirrors. Tazzas. Temples.	
Napkin rings. Nightlight stands. Nut crackers. Nutmeg graters.	Vases. Wall brackets. Wall light brackets. Wall mirrors.	
Pepper boxes. Pickle stands. Punch bowls.	Watch stands. Wax taper stands. What-nots.	
Rolling pins.		
Salad bowls. Salt cellars. Sodawater stands. Spice boxes. Spill holders. Snuff boxes. Stoppers for bottles. String boxes. Sugar sifters.		

TABULAR VIEW

OF WORKS IN PLAIN TURNING IN WOOD AND IVORY.

<p style="text-align: center;">TOILET.</p> <hr/> <p>Bonbon boxes. Bonnet stands. Bracelets. Brooches. Bouquet holders. Bottle cases. Buttons. Chains. Chatelaines. Crosses. Earrings. Fans. Folding screens. Glove stretchers. Hair rollers. Hand mirrors. Jewel cases. Lipsalve boxes. Lockets. Match boxes. Mirror frames. Necklaces. Parasol handles. Pincushions. Pin trays. Pocket mirrors. Portable hanging ward- robes. Powder boxes. Ring holders. Scarf pins. Scarf rings. Scent bottle stands. Scent boxes. Shaving brushes. Shirt studs. Sleeve links. Solitaire studs. Sovereign boxes.</p> <hr/>	<p>Electrical apparatus. Erasers. Hygrometers. India rubber holders. Inkstands. Letter balances. Letter holders. Magnifier frames. Microscope stands. Opera glasses. Paper weights. Pedestal for globes. Pencil cases. Penholders. Penracks and cases. Rulers. Seal handles. Sundials. Taper stands. Telephones. Telescopes. Telescopes, cases and stands. Thermometers.</p> <hr/>	<p>Rattles. Solitaire boards. Spinning tops. Toy, breakfast, dinner, dessert, and tea ser- vices. Whipping tops. Whist counters. Whist markers.</p> <hr/>
<p style="text-align: center;">STUDY AND SCIENTIFIC.</p> <hr/> <p>Almanacks. Barometers. Brush penwipers. Compass cases.</p>	<p style="text-align: center;">GAMES AND TOYS.</p> <hr/> <p>Bandelores. Bagatelle balls. Besique markers. Billiard balls. Billiard chalk cases. Bowls. Chessmen. Cone to run up hill. Conjuring tricks. Cribbage boards and pegs. Croquet balls. Croquet mallets. Cup and ball. Dice. Dice boxes. Draughtsmen. Hoop sticks. Humming tops. Military tactics. Ninepins. Pegtops. Pope Joan Boards. Portable Chessmen. Puzzles.</p>	<p style="text-align: center;">MISCELLANEOUS.</p> <hr/> <p>Acoustic instruments. Bells of speaking tubes. Castanettes. Chairman's hammers. Chinese balls. Crutches. Geometrical solids. Gum rings. Handles for carpenter's tools. Handles for turning tools. Harness rings. Horse cradles. Mallets. Mauls. Measures. Musical instruments. " clarionettes. " drumsticks. " flageolettes. " flutes. " piccolos. " oboes and others. " violin pegs. Pestles and mortars. Profile rings. Solids in ball. Solid profiles. Star in ball. Turned furniture. Voice conductors. Violin string boxes. Walking sticks. Watch rattles. Weights. Whip handles. Whip racks. Whistles.</p>

SECTION II.—AXIAL OR SIMPLE PLAIN TURNING.

The manipulation of the hand tools employed in the production of the following specimens, requires little further elucidation than that already given upon the various surfaces and solids, in the chapters on elementary hard and soft wood turning; while the chucks referred to, together with their more particular purposes, have been also already described. The tools to be used will be mentioned, and the mode indicated, together with collateral matters so far as may appear necessary; but attention will be principally directed to the various methods of chucking, the precautions observed to ensure concentric truth upon the different surfaces, the most suitable positions for the joints, and the modes of fitting together the various pieces of which the work is composed.

Works of moderate dimensions turned between centers, that is, carried by the prong chuck or the square hole chuck, and supported by the point of the popit head; which, consisting of single pieces of material the length way of the grain, may be finished at one chucking, will be first described; and it will be observed that much that may be said upon the production of these simple forms, applies as directly to the formation of the parts of more elaborate specimens. A ruler, a rolling pin, and various rods and handles are familiar examples; the precautions followed in turning the cylinder have been described, a tool handle, fig. 608, and a nine-pin, fig. 609, will serve as plain and more ornate specimens of the class.

Short turning tool handles of the form of fig. 608, range from about five to eight inches in length, and the material, whether of hard or softwood, is usually cut out square by the saw, of just sufficient size for the largest diameter to be contained by its square sides. These pieces are carried by a square hole chuck, fig. 195. When turned of beech or other softwood, a gouge about an inch and a quarter wide, lying on its back as in turning the cylinder, is first employed to turn away the corners and rough the piece true to the taper form shown by the dotted lines; the tee of the rest being placed close to the work, and remaining parallel with its axis throughout this and the following operations. A chisel of about half the width of the gouge, is then used to turn down the end

nearly cylindrical to receive the brass ferrule. The tool is first applied as in turning a surface, supported on its edge, the acute corner beneath, with the bevil of the cutting edge next the chuck at right angles to the axis of the work. A surface incision is made to form a square shoulder, a sufficient distance from the end to meet the square edge of the ferrule; and then lying on its face as in turning a cylinder, the tool is employed to reduce the pin, for which latter cut, the chisel being wider than the length of the pin, it does not require traversing. These two cuts, which are also employed in making the external plain fitting for joining any two pieces of softwood, are continued alternately, until the pin, left very slightly taper, is reduced to the required size; a pair of callipers or a piece of sheet metal filed with a deep notch being used to gage the diameter.

The method of cutting up the brass tube into short lengths for the ferrules, is shown by fig. 196. The tube is placed upon

Fig. 608.

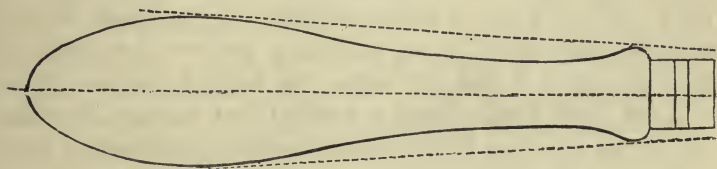

a wooden arbor, usually turned from one of the pieces cut out for the handles being made, which passes easily within it and is parallel, except close to the chuck end where the arbor is left slightly taper to hold the tube. The width of the ferrules are scored upon the revolving tube with the points of a pair of compasses, after which a thick, acute point tool, fig. 448, is used to divide the whole, commencing at the end next the popit head; the bevil on the left side of the tool being held at right angles to the work, which leaves every ferrule with one true flat end. The pin turned upon the handle is inserted in the square end of a ferrule, and the two are held vertically upon some hard surface, while the former is driven into the latter with the hammer; the pin being rather less in length than the ferrule, the two surfaces arrive in exact contact. The work is then returned to the lathe, the end of the ferrule is turned true and square with the same point tool, and its

cylindrical portion with a flat tool, fig. 452; a small quantity of brass lacker being immediately applied with a brush to preserve the bright surface from subsequent tarnish, the heat arising from the turning serving to instantly evaporate the spirit and dry the lacker. The ferrule may be ornamented with a milling tool or by one or two fine lines cut upon it with the point tool, previously to its being lackered.

The work still in revolution then has the total length scored upon it, by one point of a pair of wing compasses opened to the size, the other point being held against the end of the ferrule. After which it is turned down nearly to the finished form with the gouge, lying always upon its back; the end near the chuck being nicked in, somewhat after the manner described in turning the back surface. The largest diameter upon the swell, and the smallest upon the neck, are determined by the callipers, or when turning quantities, by two other notches cut in the sheet metal gage, previously used, so as to leave the work with but little to be removed by the chisel, with which the form is then completed. The chisel is held and used, very much as in turning a soft wood cylinder or cone; the edge is first laid upon the highest portion of the swell, its shaft having both a vertical and horizontal angle, both the corners free of the work; the blade is traversed down hill towards the right, the obtuse angle leading, following the contour given by the gouge until the shaving removed has been carried so far as the smallest diameter of the neck. Whereupon the chisel is removed, turned over and laid upon the highest portion of the round next the ferrule; the horizontal angle being thus reversed, the tool is traversed from right to left until this shaving merges into the preceding cut.

The chisel is then again reversed and placed upon the top of the round next the ferrule to turn its short curve, which is half that of a bead, much after the manner of turning a small sphere. The bevil is laid on the top of the round by a portion of the cutting edge very close to its obtuse corner, with the shaft, at about right angles to the axis of the work, and then, without permitting the shaft to obtain any horizontal inclination, it is slightly rotated upon itself by the right hand holding the handle, until the obtuse corner arrives at the ferrule. For the fourth and concluding cut, the chisel

once more reversed, the obtuse angle thus always leading, is laid upon the top of the swell and traversed towards the left, being brought to rest nearly upon its side, as it arrives at the point of the handle to sever that from the piece remaining in the chuck.

There is no difficulty in exactly joining these four cuts so as to form one continuous surface or curve, the junction upon the neck only requiring rather more care than that upon the convexities, to prevent the one side of the hollow curve dipping below the level of the other or joining in a flat. It is more likely until after a little practice, that the curves will be turned flatter than is intended, but this may be avoided by at first turning the form pretty accurately with the gouge, and then endeavouring to take an equal shaving all along it with the chisel; bearing in mind that the blade of the chisel in traversing the curve acquires, but in a *very* slight degree, the twist described for turning the softwood sphere. The position of the left hand placed around the work with the thumb upon the blade of the chisel, page 264, may also be used with advantage. Some of, or all the four cuts will require repetition, but when a number of one size of handles are turned, the form and direction of the curves are soon appreciated, when they may often be correctly produced by single traverses of the tool, provided the gouge has been efficiently used in roughing out the form.

Hardwood handles may be turned in a similar manner with the gouge and chisel, but ground to the less acute angle suitable to the material; or they may be rough turned to shape with the gouge and finished with the flat and bevil tools for hardwood. In traversing the convex curves, the flat tool is held in the horizontal manner, lying flat on the rest; upon the concaves, it is slightly tilted upon one of the sides of the blade, page 303, to place the corners of the cutting edge free of the work. The bevil tool, fig. 387, may be used for the portion from the point to the top of the swell. In turning handles in quantity every piece is turned taper with the gouge and the pin turned to the size for the ferrule, all are then driven into their ferrules; the different pieces are then returned to the lathe, the ferrules finished, and the gouge, chisel or other tools consecutively used upon each. The last process is

to strike a deep center punch mark on either side of the ferrule, to prevent it loosening from possible shrinkage of the wood; the ferrule end being supported in an angular notch cut in the end way of the grain of a piece of hardwood, used held in the bench vice.

The handles when turned have to be bored, and may require glass paper for smooth finish. A carpenter's nose or spoon bit of small size is employed, mounted in a boxwood chuck, in figs. 231. 232, or in one of the die chucks; the handles are thrust straight on to the bit by the hand, and are frequently withdrawn to clear the former from the accumulated shavings, the bit being also lubricated from time to time with tallow.

The bit is then exchanged for a slender, taper arbor, made from a piece of steel wire and mounted in a chuck in a similar manner; the handles are thrust on to this by the hand, which gives them a sufficient hold for glass papering and polishing.

The round hole in the handle is subsequently enlarged to fit the taper tang of the tool, being fretted out to a rectangular shape with floats, taper steel tools, some narrow and comparatively thick, others wide and thin, cut across upon one face with teeth resembling those of a coarse saw. A different form of tool handle, used for hammers and screw drivers, has a wide, flat surface on either side at its largest diameter. The material is sawn out of oblong section, and is carried between the point of the popit head and a taper, hollow plain wood chuck, or for quantities, in fig. 193. The extreme corners at the one end, are first roughly cut off in the direction of their length with the turning chisel, from every piece as it is placed in the chuck, that it may more readily seat itself in the circular aperture. The turning is precisely the same as for fig. 608; but the cutting is intermittent at the larger part of the handle where the flats occur, analogous to the steel key, fig. 491, wood however permits the circular portions and the edges of the flat part to be entirely turned to shape. The flat sides are planed smooth after the turning is completed.

The nine-pin, fig. 609, varying from four to twelve inches high, would be turned from material roughly rounded with the axe or paring knife, mounted between the prong chuck and the point of the popit head. Several being required all precisely alike, the work is executed upon some system to ensure

similarity, one being generally turned to the finished form to serve as a model for the remainder; the mode of turning the various forms upon fig. 609 in softwood, will serve also for all analogous curves in that material.

The piece is first turned roughly cylindrical with the gouge, and the end true with the chisel, as in turning the surface fig. 349. The total length of the work is then marked off upon the cylinder, and the latter is nicked in as in turning the back surface, leaving the end square for the base, at a little distance beyond this mark. Measured from this square edge, the distances and widths of the band, astragal and bead of the head, B C and D are then scored on the revolving work with the compasses, taking care to mark the widths of all in excess of that required. Shallow surface incisions are then made with the chisel, supported vertically upon its edge, at all the lines

Fig. 609.

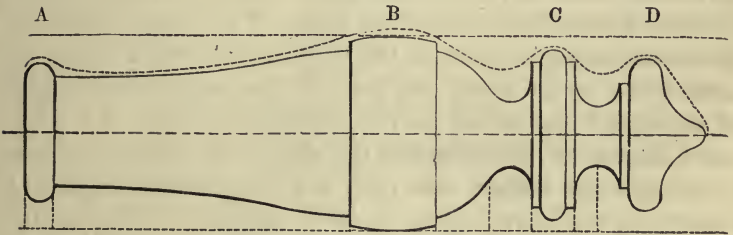

marked to denote the widths of the different mouldings; the whole form is then reduced somewhat to that of the dotted line with the gouge, taking precaution to leave sufficient diameters for the mouldings, and also to deepen the vertical cuts at C and D, that they may not become obliterated by the process of reduction. The band and other projections are then more carefully reduced in diameter with the gouge, under the guidance of callipers, and the long curves retraced with the tool, so as to leave but little to be removed by the chisel, with which the form is principally completed.

The bead at the base A is first completed by separate cuts made with a narrow chisel, used in the manner described in turning the half bead next the ferrule upon the handle, fig. 608. One side having been shaped, the chisel is turned over, again laid on the top of the bead and twisted in the reverse direction

to form the opposite half; these two cuts being in part or wholly repeated, as may prove necessary in gradually reducing the bead to diameter and its two sides to precise similarity of curvature. The under edge of the band B is then turned square with the chisel, presented on its edge as in turning the surface, the one bevil of the cutting edge at right angles to the axis of the work; the tool carefully prevented from cutting to a greater depth, than will rather less than suffice for that of the edge of the band. In working to a copy, a succession of these thin cuts would be made, until the distance from the under side of the band to the under side of the base, is found to agree with that in the original. The width of the band may next be determined by measurement and a series of surface cuts upon its upper edge, after the same manner.

The long curve from B to A is then turned with a wider chisel, in the same manner as the curve of the handle, fig. 608, travelling down hill, the obtuse angle leading, until it arrives in contact with the bead at the base. The chisel lies at an horizontal angle, as that to the right in fig. 339, to place its corners free of the work, and there is therefore a narrow width of the upper end of the curve, immediately under the band, which cannot be reached unless the shaft of the chisel be placed at about right angles, and then not conveniently, from the liability of the acute corner to catch against the edge of the band. To turn this narrow portion, which occurs in all similar curves starting from a shoulder and sloping downwards, the chisel has to be turned over to lie in the position of that on the left fig. 339. So applied on the curve, the chisel is cutting uphill and against the grain; it is therefore traversed as little as possible, being rather held in such a position, that its obtuse corner will just arrive against the shoulder upon the tool being made to cut by slightly raising the handle. The short portion referred to close under the band, would be first turned and the chisel then reversed to continue the shaving to the end of the curve.

Upon a small scale, the curve from the upper edge of the band to the edge of the lower fillet of the astragal, would be entirely turned with the gouge; that selected, fig. 327, being small and ground to the elliptical cutting edge referred to. The tool is applied lying exactly on its side, its long *bevil* at right angles to the axis of the work, and in absolute contact

with the square upper edge of the band. It then for the first moment cuts by the center of its elliptical edge, but so soon as its traverse commences, the shaft is gently twisted to cause the tool to lie a little less on its side, while traversing the roundest portion of the curve, when it cuts by a part of the edge *slightly* to the left of the center. As the shaving is continued into the hollow, the gouge is as gradually turned back again so as to be again supported on its side, in which position the tool remains until it arrives at the center of the neck. It is then withdrawn, turned over, and again upon its side with the bevil at right angles to the axis, is applied to the edge of the fillet of the astragal, to turn the opposite half of the curve. The gouge is thrust almost straight forward for the upper part of this curve, after which it is slightly twisted to lie less on its side, while it also receives a slight traverse on the rest, as it meets the termination of the opposing cut.

Upon larger examples, the convex portion of this curve so far as the vertical dotted line, would be more conveniently turned with the chisel; the remainder and the opposite side, with the gouge as described. The obtuse corner of the edge of the chisel would be first applied against the upper shoulder of the band, to turn a short length of the curve for the reasons lately given; the blade would then be turned over, to continue the curve from this so far as the vertical dotted line, the curve being obtained partly by traversing the chisel but more by twisting the shaft as in turning a sphere. The gouge would then be used to continue the curve to the bottom of the hollow; first tracing a portion of that just cut by the chisel, supported on its edge but without cutting, and then as it commences to act, being gradually twisted until it lies on the center of its back when it arrives at the smallest part of the neck. The opposite half of the curve starting from the under edge of the fillet, is in both cases gradually formed by more than one traverse of the gouge, so that guided by measurement, it may determine the distance of the edge of the fillet of the astragal from the base. The width of the complete astragal is then reduced upon its upper edge by the chisel, as with the band, and the position for the under side of the head being found, the curve connecting the two is next turned. This second neck being reduced to the same diameter as the first as measured by the callipers,

and the opposing sides of the two hollows turned to precisely similar curvatures.

The edge of B is next turned with the chisel to the diameter and flat curve of the copy, and the round of the astragal and that of the head, the parts remaining for completion, are reduced with the chisel to very nearly their finished diameters. The fillets of the astragal then have their equal widths determined by several slight surface cuts, given with the chisel upon either side of the central piece to the left to form the round, alternated, by shavings removed from their cylindrical faces to determine their diameter; the obtuse corner of the chisel used in these two directions leaving well defined internal square corners, without being permitted to cut into either the cylindrical or the horizontal faces produced. The chisel if sufficiently narrow, is used upon the cylindrical faces lying almost flat upon the rest; but, when the blade is so wide that it would catch against the head on the one side or the band on the other, the tool is presented to the work supported on its edge, with the blade inclined vertically to right and left; when the cylindrical faces and internal corners of the fillets are produced with equal accuracy, and without risk of injury to the neighbouring portions. The bead of the astragal and the round edge of the head with its underlying fillet, are then completed with the chisel; the surface curve of the head being turned last, with the gouge travelling down hill, supported first upon its side, then gradually twisted to lie nearly upon its back and then again on to its side; when, the total length of the material being rather in excess of the finished length, as was originally permitted, the gouge leaves a little piece between the point of the work and that of the popit head.

The completed work is then very nearly severed from the piece on the chuck, so that the two may be easily broken apart, after the little piece left at the point has been cut through with the chisel; the left hand being placed around the work while this concluding cut is made, to catch it as it falls free from its supports. In turning this object in hardwood the widths would also be marked out upon the rough turned form as that progressed, the gouge and chisel would also suffice, but the flat and round tools for hardwood held in the horizontal manner, would generally replace them and be preferred as more conve-

nient. The manipulation of these tools upon fig. 609, offers no variation from that detailed in Chapter VII.

The preceding examples would probably require the application of glass paper, and possibly the further finish of their surfaces by polishing. It should be noted however, that upon all the better works in softwood, hardwood or ivory, the use of glass paper is avoided so far as possible, from the facility with which it obliterates the sharpness and correctness of the angles and forms turned. With tools in good condition as to their cutting angles, and with a little practise in their use, the work may generally be so smoothly turned as to reduce the necessity for glass paper to a minimum, sometimes even to render it unnecessary, and when requisite it is applied to the more carefully finished works with the following precautions. Upon cylinders and long curves approaching that character, such as fig. 608, a piece of fine glass paper about three or four inches square, is held around the revolving work in the hollow of the hand. The glass paper is never allowed to be strictly quiescent but while used constantly receives a small backward and forward movement in two directions, both laterally with respect to the axis and also around the work, to avoid marking the surfaces with rings; this being varied by occasionally stopping the motion of the lathe, that the glass paper may then be used upon the work in the direction of its length, to obliterate any circular marks that may have formed.

This alternation is more necessary upon surfaces which are very liable to be marked in rings that become apparent through the subsequent polish. Surface work has the glass paper first applied while in revolution and then at intervals in various directions across the diameter, the lathe being at rest and the left hand laid upon the mandrel pulley to retain the work at different positions. Upon the surface and upon some cylindrical forms, such as square bands, edges and fillets, the result is considerably better when the glass paper is used tightly wrapped around a true flat piece of wood for the former, and on a straight square slip for the latter; the accurate faces of the rubber tending to preserve those of the work. For quirks and angular grooves, unless these are of sufficient size

to admit a corresponding rubber, the glass paper is once or twice folded and the stiff edge placed within them. It is also folded or rolled up for small concaves, but whenever possible it is used upon a straight piece of wood having a rounded edge, and sufficiently narrow to be twisted about within the hollow; for larger concaves and for most cavities, it is applied upon the fingers or the end of the thumb. For flat internal surfaces, edges and angles, the glass paper may be wrapped around a small flat piece or cube of wood, analogous to the rubber for the external forms. Glass papering is usually concluded with a finer cutting paper, or with pieces upon which the cutting action has nearly worn away. Roughly turned works in softwood submitted to the action of glass paper, have any loose fibres not immediately removed by it, laid down flat in the one direction; the work may then be set in revolution in the reverse path, by which they are brushed up and carried away.

The various works left uniformly smooth from the tool or glass paper, are polished by different processes varying with their material and the degree of finish required, the following are the more general; the reader is also referred to the third volume, for notices upon polishing all the different substances used in the arts, and for the preparation of the materials and tools used for this purpose.

A large proportion of works turned in the softer woods, acquire a clean and sufficiently polished surface from simple friction, given to them while in revolution by a handful of their own shavings; this being sometimes followed by similar friction given with a clean cloth. The darker coloured softwoods are also polished by being lightly rubbed over with wax with the addition of a little resin, dissolved with heat in turpentine to the consistence of paste, applied on a piece of flannel; a slight coat is allowed to remain on them for some hours, the work is then returned to the lathe and as much as possible is removed and the polish completed by friction with dry clean flannel. The various softwoods previously treated with a coat of strong size and allowed to dry, are frequently varnished; one or two coats of sandarac or white hard varnish are usually employed, and the surface thus given is sometimes then rubbed down with fine glass paper and again varnished or polished,
page 1399 Vol. III.

Hardwoods also receive a polish from the wax mixture, but being less absorbent, the wax requires more thorough removal, especially from all internal angles; the subsequent friction is continued until the work no longer receives marks from the fingers when taken in the hand. The effect upon either hard or softwood is permanent, the work always brightening when rubbed with a brush or cloth.

A superior polish for the closest grained hardwoods, results from abrading their finished surfaces with rottenstone, tripoli or dutch rush; the process being in fact simply that of continuing the finishing with glass paper by other, finer cutting materials. The polish or rather the exceedingly smooth surface produced is permanent and the method is employed for many of the best works, especially for those having frequent angles and small well turned mouldings, which it is not so advisable to lacker. The work left as smooth as possible from the tool, and carefully finished where necessary with fine glass paper, with the precautions already mentioned, first has its surfaces and all mouldings thoroughly cleansed from any particles of the glass and dust produced. A piece of flannel once or twice folded so as to form a square of about three inches, has one side moistened with oil and then covered with a thin layer of rottenstone or yellow tripoli, the latter being always used for the lighter coloured woods; this rubber is employed in the same manner as the glass paper, being used alternately while the work is in revolution, and then while it stands still, lengthwise upon the cylinder or across a surface. The soft rubber easily accommodates itself to the form of the work, but for penetrating very small mouldings the flannel may require to be used only once folded and to be carried in by the thumb-nail, or the end of a small piece of stick; the powder gradually dries and at the same time becomes crushed and finer from the friction, the cutting action therefore gradually becomes more delicate, eventually leaving a very smooth surface, to preserve which advantage additional tripoli is not used except at the early stages of the polishing.

Dutch rush produces similar results upon very close grained hardwoods and upon ivory. A small bundle loosely bound together at the ends, formed of a moderate quantity of the short lengths of the rush cut from between its knots, and

frequently dipped in water while used, is pressed and rolled about upon the revolving work, so that all sides of the rush may be equally used, until its cutting action is apparently lost. The rush soft and inoperative, is then laid aside to dry and a fresh quantity used if required. The work being also allowed to dry, the worn rush when dried is then used to complete the polishing.

The majority of works in hardwood are polished with the spirit polish, known as hardwood lacker; the process has been noticed, page 1413, Vol. III., but being both expeditious and suitable to most of the following examples, further description may be convenient in this place. For the best results, the work left smooth from the tool or glass paper and wiped clean as before, has the lacker applied to it upon a soft rubber, which varies from very small to about the size of a walnut, according to the dimensions of the work. The rubbers consist of cotton wool, or for large works for which they must be more enduring, of several small pieces of soft clean rag folded one over the other; either kind being enclosed in one thickness of rag which is then gathered together behind and tied, so as to form a soft ball. When used the face of the rubber is rather plentifully supplied with the lacker, by gently pouring a small quantity upon it from the bottle, or, the lacker is placed upon it with a brush, which, as conveying only the supernatant fluid is to be preferred; the rubber is then covered by a single thickness of fine clean rag, the edges of which are gathered and held together behind by the fingers. The finer portions of the lacker penetrate this covering, and one or two drops of linseed oil, placed on the center of the lacker coming through the external rag, completes the preparation.

The rubber is then carried along over all parts of the gently revolving work with a slight, equal pressure, neither the hand nor the work remaining still for a moment; the lacker rapidly transferring itself from the one to the other, so as soon to require replenishing. This occurs many times, but most rapidly in the early stages until the pores of the wood become thoroughly filled, for the rubber is never allowed to become dry, which would cause it to adhere to and damage the tender polish; gently squeezing the rubber occasionally with the fingers, brings the lacker to the surface and reveals its con-

dition as to dryness. Several successive applications are required, during which the rubber is allowed to linger within internal angles and hollows and upon any portions of the work that appear to have been at all neglected, all parts the end way of the grain being more absorbent, receiving a larger supply. On the other hand should the rubber be overfilled, or allowed to remain too long upon them, the lacker is apt to collect upon external, and within internal angles, and small grooves or mouldings; as the polishing is continued therefore and the work becomes coated with the lacker, the rubber is used both with a lighter hand and for a longer period without replenishment, while the motion of the lathe is also occasionally stayed, that it may be used lengthwise upon all cylindrical forms, and across surfaces, to render the entire thin coating flat and uniform. Should the loose covering of the rubber show signs of becoming hard after some use, it is immediately renewed to prevent possible damage; the small quantity of oil used with every supply of lacker and required to relieve the friction, being never omitted.

The lackering is continued until the surfaces acquire a brilliant uniform polish, and the work, still upon the chuck, is then set aside to harden. After a few days the brilliancy of the polish will probably somewhat diminish from the continued absorption of the wood, the surface also appearing partially cloudy, arising from the oil used. Time having been allowed for absorption, a slight repetition of the lackering restores the brilliancy of the polish which is then generally permanent, after which, the work is lightly gone over with a small quantity of spirits of wine upon a fresh cotton wool rubber; this, called *spiriting off*, entirely removes all cloudiness, together with the small quantity of oil from which it arises; but spiriting off is confined to the barest necessity, for if continued it gradually removes the surface of the lacker. For works less carefully polished, the rubber may be placed on the mouth of the lacker bottle and the two then shaken together, and the oil added as before; while for inferior works, a more plentiful supply of oil is first put on the rubber and then the lacker, the external covering of rag being discarded.

Polishing with hardwood lacker is also employed for improving the colour of a pale specimen of wood, or for darkening

one piece to agree with the colour of a better, the colouring matters used, described in the last chapter, being steeped in the oil or in the lacker. For slightly toning the work, the coloured oil, but rather more in quantity, is employed in the manner already described; for a more considerable effect, the rubber is saturated with the coloured oil and the lacker put upon that.

In all polishing with hardwood lacker, it should also be noticed, that the rubber is never directly lifted off the work unless that be in revolution, when the work is still, it is always *swept* off at the termination of one of the straight strokes to avoid the risk of its adhering to and removing a small patch of the yet soft polish. Damage to the surface from the rubber adhering, or from the accidental intrusion of any foreign particle, causes the lacker to rapidly collect about and to aggravate the blemish, the sole remedy then being to entirely remove the lacker with fine glass paper and to recommence. It may also happen that portions of the work may prove to be coated with unequal thicknesses of the lacker, arising either from want of sufficient exactness in previously finishing the work, or of care in the polishing; in such cases, the polish when thoroughly hardened, is levelled with fine glass paper and the work relackered. Very excellent results may be obtained by thus rubbing down and relackered, and this practice is necessary, as in the analogous process of varnishing, when it is desired to cover the work with a more considerable coating. It is perhaps hardly necessary to add that all defects and accidents to the surface should be entirely removed, or when that is not possible, as in the case of holes or fissures, these are filled with melted shellac or other material, prior to the polishing, which otherwise gives them increased prominence, in the same degree that it exhibits the beauty of the grain of the wood.

Ivory is a material easily left smooth from the tool, and as facile to polish. It readily receives scratches from glass paper, the use of this is therefore limited so far as possible, and that used is of the finest character or much worn; it is good practice for ivory, as also to obtain the smoothest surface upon hardwood, to first rub the pieces of glass paper face to face, to level any particles that may be in excess. Dutch rush may

replace the glass paper, and although slower and less convenient, it is free from most of the objections to the latter. Cleansed from the dust of the glass papering, works in ivory are polished with *washed* whiting mixed with water to the consistence of cream, contained in a shallow vessel placed under the work, and applied upon folded rag as a thin rubber; the latter is employed in precisely the same manner in all respects as if it were a piece of glass paper, with the same precautions to avoid marking rings upon the work, and it is never allowed to become dry. A small flat piece of soft deal plentifully supplied with the whiting and water, is employed with advantage upon flat surfaces, and a square slip, upon square fillets, edges and internal angles; the end of a slip of deal dipped in the whiting and water, is employed for small mouldings and incised ornament, into which it soon fits by wear. The smooth mixture of whiting cuts with more vigour than might be supposed, the process therefore has to be conducted with care and with a thin rubber, that all edges may be felt with the fingers, and the use of the flat slip of wood resorted to, to avoid deteriorating the forms of the angles turned upon the work. A moderate but equal continuance of the polishing suffices, when, so soon as the work ceases to hang to, and is felt to run quite smoothly under the rag, it is discontinued, and the work is thoroughly washed with water and allowed to dry, still upon the chuck; in which condition it is subsequently finished and acquires a brilliant polish from friction, given with a few drops of neat's foot oil upon clean soft rag.

Figs. 610 to 620, forms having little ornament, and ranging from one and a half to about seven inches high, used for *Egg cups*, *Salt cellars*, *Match and Spill pots*, and to contain glasses as *Flower holders*, may be turned either in hard or softwood, in most cases from single pieces of the material. All having to be hollowed with large apertures leaving only a narrow annular surface, the material selected is first mounted between centers, or in the chuck, fig. 286, that one end may be turned down true, slightly taper and surfaced, to fit within a plain chuck, fig. 256, which carries the work; so as to dispense, more or less, with the support of the popit head. For the larger among

these works when mounted in the plain chuck, it is however frequently a safeguard to use the popit head, when much of the material has to be turned away in first roughing the work to external form, and then to remove it for the hollowing and finishing.

In softwood all would be turned from material the length-way of the grain with the gouge and chisel, in a similar manner and with the same precautions, as with fig. 609; the general dimensions of any one, being arranged to the proportions of the piece of material employed. The latter having been securely chucked and roughly turned true, the position of the under surface of the base, is first marked by a line cut in the cylinder with the chisel, always leaving the available material a little in excess of the finished height of the design. The widths of the different curves composing the outline, being also all set out and marked from the same line upwards during the progress of the work, the excess of length is finally reduced in turning the surface and form of the uppermost moulding.

The outlines having been turned nearly to the form with the gouge, all are finished with the chisel, with the exception of the three small concave curves shown in the feet of three of the figures, which are completed with the gouge. Upon the tapering cylindrical curves of such forms as figs. 616. 617 and 618, the edge of the chisel is first presented with its obtuse corner against the projecting moulding or other form at the upper end, to turn the adjacent short portion, which as already explained cannot be otherwise conveniently nor safely reached; the blade is then turned over to proceed downhill for the remainder of the curve, the obtuse corner thus also arriving in contact with the lower projection. No such precaution is necessary upon fig. 615, where the chisel travels downhill along both halves of the curve, the obtuse angle thus meeting first the one and then the other side of the astragal, of which the fillets and their square edges have been previously formed by the chisel. The tapering outlines of fig. 620 are turned as cones; while that of fig. 619 may be considered as merely the curve of the handle, fig. 608, enforced. The chisel is employed upon the latter and upon all the other curves in these outlines in a similar way, travelling from the largest to the smallest

610.



611.



612.



613.



614.



616.

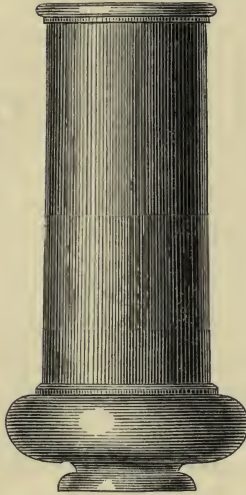

615.



617.

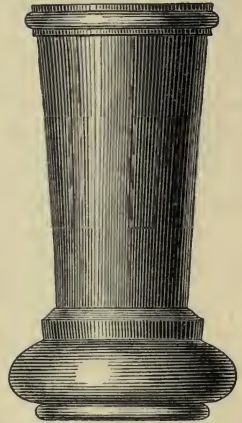

619.



618.

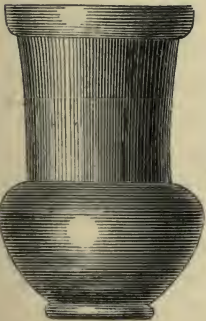

620.

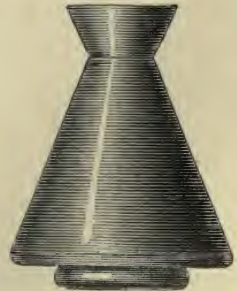

diameter, first upon one and then upon the other half of the curve; in some of the more rapid curvatures being guided as upon the sphere, but the obtuse angle always leading. The three central figures are among other examples of forms which overhang their base; these when chucked in the manner supposed, require an additional length of material left between the form and the edge of the chuck, and turned down beneath the diameter of the base, to allow sufficient space to admit the chisel in turning the mouldings on the foot.

The internal turning in softwood, is commenced with a deep hole bored with a small nose or spoon bit, which may then be increased with a larger, and afterwards enlarged with the gouge, hook and side tools. Short internal curvatures, as in the four smaller of the specimens and others of moderate depth, may be entirely completed with the gouge; the tool being generally used upon portions in the reversed position, fig. 365. Deeper hollows, some of which have straight or nearly straight sides, are turned near the mouth with the gouge, and then completed with the hook and side tools; the use of all the foregoing being described in the elementary chapter.

In hardwood and ivory, the external forms marked off as before, are shaped with the gouge, and finished with flat, point, round, half round and bead tools, held in the horizontal manner and presented to the work as in figs. 438. 439 and preceding illustrations. The apertures are commenced with a hand drill, and when deep are conveniently enlarged with half round or other boring bits, followed by right side, round and other tools used upon the armrest.

In several of the foregoing and in turning many other hollowed works, the following sequence is observed; the external form is first roughly approximated to the required shape, but left everywhere much too large in diameter, the aperture is next bored nearly to the depth and enlarged, but left less than its finished size in about a corresponding degree. The external form is then nearly reduced to its longitudinal measurements and finished diameters, followed by the completion of the aperture; after which the external form and its enrichments receive their final corrections. This alternate system is pursued to avoid risk of splitting the work, to permit small alterations in the design, the necessity for which may arise from imperfections appearing

in the material, and to counteract expansion in the apertures, a source of inconvenience which will be further noticed.

The finished work, perhaps lightly touched with glass paper and polished, is separated from the portion remaining in the chuck, in softwood, by the chisel, as in fig. 349, or by the parting tool; in hardwood, most readily by the parting tool appropriate to that material. A flat under surface or at least one that is not convex, is necessary that the finished work may stand steadily; the base may be made slightly concave by directing the tool at a small horizontal angle from circumference to center, the little neck unavoidably left at the center of the face by the parting tool, being subsequently cut away by hand. When a flat base is required, the work is re-chucked reversed, that it may be treated as in turning a surface, figs. 349 and 418. Works of short length are then lightly held within the rebate of a plain wood chuck, or in a wood spring chuck, those of greater length in the same manner, but when adjusted to run true the latter generally receive the support of the popit head to prevent their accidental displacement; with the popit head, the softwood surface is turned with a chisel, that of hardwood, with the point or bevil tool, fig. 414.

The *Black bottle stands*, figs. 624. 626 to 630, and the *Ash or Pin trays*, figs. 637 to 639, varying from about one to three inches high, may also be turned from single pieces of the material. When of softwood the length way of the grain, the piece mounted between centers would first have a narrow width turned down at the end, by which it is placed in a plain chuck, the general form would then be given with the gouge, after which the cylindrical or curved apertures would be finished to their required size and form. Some would then be entirely finished as to external form; with others, the curvatures upon the upper portions would alone be turned to shape with the gouge and finished with the chisel, and then the annular surface turned flat under the guidance of a straight edge, held across the diameter of the work. The finished portions are then treated with glass paper if required, and polished with a handful of their shavings. The work is next detached from the chuck, reversed and remounted by its aperture upon an external rebate, turned upon a plain wood chuck, fig. 257; the flat surface of the base may then be turned together with

621.

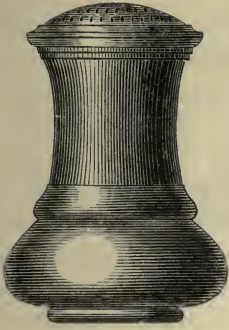

622.

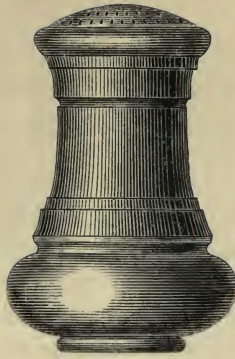

623.

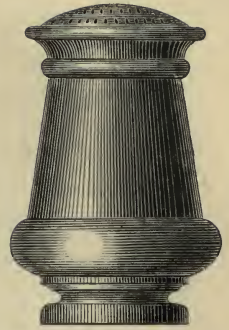

624.

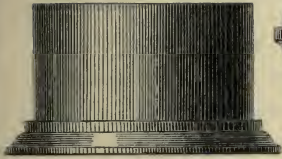

625.

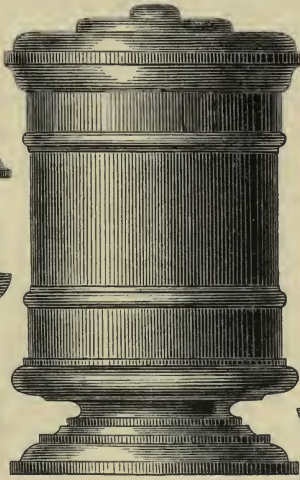

626.

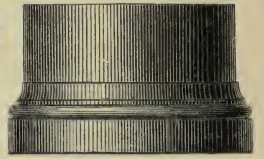

627.



628.



629.

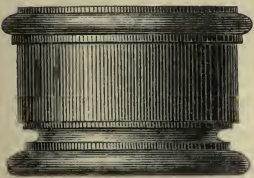

630.

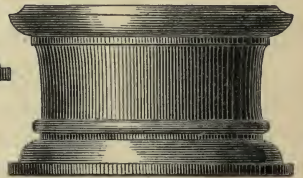

631.

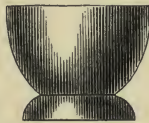

632.

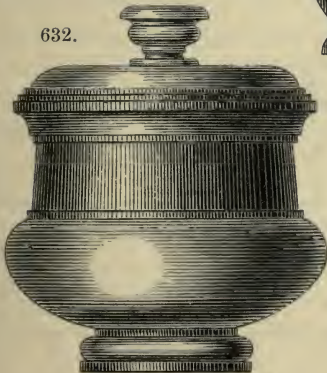

633.

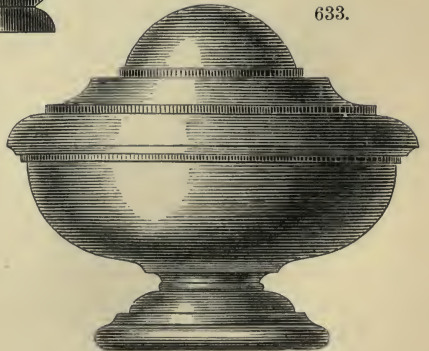

the lower curvatures, with far greater convenience than in their former position, while if necessary the part previously within the plain chuck may be used to add to the height of the foot.

The rebate upon the chuck for holding these or any parts of work partially turned, is formed with precision; the cylindrical portion is first turned accurately true and to the diameter, but of rather less length than the depth of the aperture in the work, the vertical face or *shoulder* is then turned flat and at right angles to it, as tested by the right angle of a small steel square, used in the same position as the blade of the turning square in fig. 427. After which, the cylinder of the rebate is turned very slightly taper towards the end, just sufficiently for it to more easily enter, and to avoid any risk of splitting the work. The true annular face of the latter coming in exact contact with the true face of the rebate, the work becomes true edgewise, and also fitting upon the concentric, quasi-cylinder of the rebate by its true aperture, it again revolves upon the same axis as before, and all the forms then turned upon it are concentric with those previously completed. This mode of chucking has also an additional advantage, the slight elasticity of the wood precluding damage to the finished edge of the work.

When the aperture is of inconsiderable depth, or contains some projecting surface but a little distance from the margin, the cylindrical portion of the fillet on the chuck is then made the longer, that its true end surface may abut against the internal surface, or the ridge within the aperture; the end surface of the fillet and its vertical shoulder, being rarely both required to touch the work. The fitting on the chuck is made to the same angle as that in works having conical apertures, and to the form of those that are curved, and is used when these works cannot be held within a chuck by their exterior margins, a more secure method. The length of fitting is increased in such cases to acquire greater surface contact, but it often happens in curved hollows that the edge or some portion of the curve is either concave or approaches the cylinder; advantage is taken of either and the rebate is turned to fit such portions, truth being always ensured when possible, by the

contact of the true shoulder or the true end surface of the fillet, with some corresponding true portion of the work.

Several of the forms last considered may be turned from single pieces of softwood the plankways of the grain. The material would be mounted upon fig. 295, with the precautions given to place it square to the flange of the chuck, and to prevent the screw penetrating both surfaces. It would generally be desirable to obliterate the screw hole thus made from the finished work, for which reason the sequence in turning last mentioned would be reversed. The screw of the chuck is inserted in the surface to be afterwards hollowed, and the general external form being turned, the lower external curvatures and the surface of the base are then finished. The work unscrewed from the screw worm chuck, is next reversed and held by the bead or the plinth at its base, within a true internal rebate in a plain wood chuck; either adjusted to run true held only by the cylindrical portion of the rebate, by pressure of the hands, or gentle taps with a poised tool handle or the hammer, or more generally, as giving greater security, in contact with its true shoulder. The aperture and upper curvatures of the work are then made and finished.

Two or more pieces turned plankways, fitted one to the other, may be requisite to obtain sufficient height, as in figs. 629. 630; or it may be convenient to make the larger diameter of plankwood, as in figs. 635. to 637, mounted upon a stem the length way of the grain. The method pursued in fitting these pieces together will occur in following examples, and a section has been previously given to the manipulation of the softwood tools, employed in turning and hollowing the plankways material.

The *Sugar* or *Flour sifters*, figs. 621. to 623, ranging from about four to six inches in height, the *String boxes*, figs. 625. 632. 633, four to eight inches high, and the *Toilet boxes*, figs. 648. to 650, from three to five inches high; would all be made from two or more pieces, the separate parts being turned mounted in plain chucks and jointed one into the other, in softwood, usually by plain fittings, in hardwood and ivory, either by plain fittings or screwed together. The first named,

634.

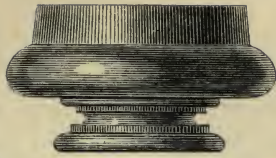

635.

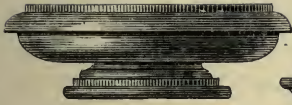

637.

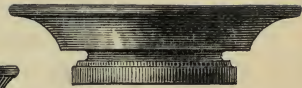

636.

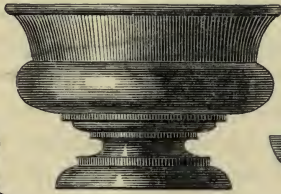

638.

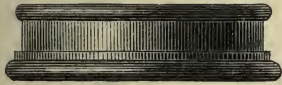

639.

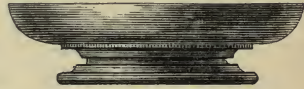

640.

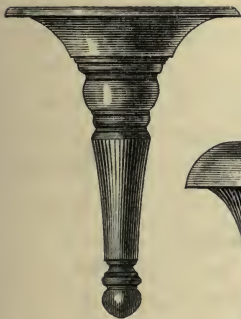

642.

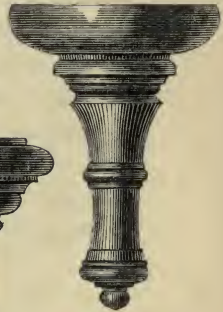

643.



644.



645.



646.



647.



648.

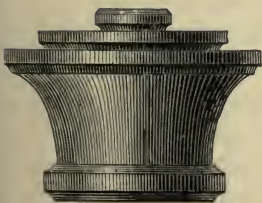

649.

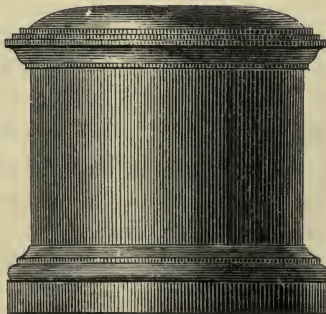

650.

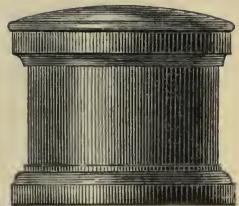

would probably require but one plain joint for the removal of the heads, the hollow being in the latter and the fillet upon the main piece. The joints would be placed beneath the two little fillets of the head of fig. 621, below the fillet beneath the large bead of the head of fig. 622, and beneath the second bead of fig. 623. The heads would be roughed out to about their largest diameters, the aperture would then be turned as an internal cylinder, under the guidance of the callipers fig. 342, its internal concave surface also completed and then the annular external surface turned accurately flat; after which the head would be cut off from the piece remaining in the chuck, and remounted by its aperture on the rebate of a plain wood chuck, to turn the external form. The same division would obtain with the toilet boxes, except that from the increased size of the base in fig. 649, it might be convenient to make this of a separate piece from the cylinder. The string boxes of larger dimensions, would probably be made in three or four pieces. Taking fig. 625 as an instance, the joint for the lid would be immediately below the ogee, the foot, neck and large moulding terminating and jointed to the cylindrical portion, would themselves probably be of two pieces joined somewhere at the neck, the larger if in softwood probably being plankways, while in addition it might be convenient to make the cylindrical portion in more than one piece.

Excepting that which is perfectly plain, the *Bouquet holders*, about five to six inches in length, turned in softwood, hardwood or ivory, figs. 640. to 644, would all be made in two pieces; the bell jointed or screwed to the stem, which would be inserted in the former. Both portions would be turned nearly to their finished dimensions, and then mounted on wood chucks to be completed; the stem being supported by the popit head.

Plain joints connecting parts of the work so closely resemble the external and internal rebates turned upon the wood chucks, that their formation requires no further description, additional care however is given in turning the shoulders on each piece square to the axis, as pointed out by the diagram fig. 355. 356, that the two may everywhere arrive in precise contact, both for stability and to make a close joint. In inferior works the

two surfaces are frequently turned at a slight angle, which, from leaving their margins more prominent attains the latter result; most permanent plain joints are also slightly glued or cemented, prior to being finally placed together.

Either half of a joint may be turned the first and the other fitted to it, as may prove more convenient to the progress of the work, but it is perhaps generally safer to turn the aperture first, and to reduce the pin or the external rebate to fit within it. The latter order will also sometimes dispense with the wood chucks. Thus the *Toilet* or *Sovereign box*, fig. 645, and other hollow work of fairly parallel form, would be turned from material driven into a plain metal chuck; this, being turned concentric and surfaced, a shallow internal cylinder and surface would be turned in the end for the aperture of the cover, the general external form of which would then be given, and this short piece cut off. The hollow for the lower part of the box would then be made in the remainder of the material, and the external rebate of the joint turned upon it, so as to tightly fit the finished aperture in the cover; it then serves to carry the latter while its external form and surface are finished. The cover being completed and removed, the internal cylinder and surface, and the external form of the lower half are in turn completed, after which the external rebate of the joint is slightly reduced in diameter and its arris rounded, that the two parts when in use, may be sufficiently easily separated by the fingers. Lastly, the lower half of the box is cut off from the piece remaining in the chuck, upon which latter an external rebate is then turned to carry the lower half by its aperture, while the under surface of the base is turned flat.

Plain joints turned upon hollow works, will sometimes subsequently lose the accuracy of their fitting from the unequal contraction of the material even when that is well seasoned; the liability being the greater when the two portions fitted together are comparatively thin and of large diameter. The tendency to contraction mentioned with fig. 538, is increased from the work being hollow, but at the same time it is always less in the short internal cylinder forming the lid than in the longer portion; while the difference may even be accidentally increased, for the rim of the lid may sometimes easily suffer a small *expansion* from remaining too tightly fitted upon the

651.

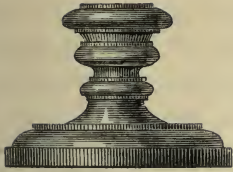

652.



653.



654.



655.



656.

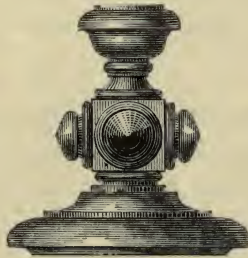

657.



658.



660.



659.



661.



rebate of the plain wood chuck, used during the reduction of the external form. Misfitting from this cause may be generally avoided, by first allowing the material to accommodate itself to its new condition. The two pieces likely to suffer contraction are prepared hollow nearly to their finished dimensions, and then put aside for a few days previously to their being fitted together. In manufacturing, such parts are roughly turned and hollowed in quantities and laid aside to season, often for a considerable time.

In thin works in ivory, more especially in those made from the hollow portion of the tooth, plain joints sometimes suffer an additional form of contraction, tending towards the original oval section of the tooth; this is counteracted by similar treatment. The construction of screw joints has been described pages 373—375; these are similarly affected by the variation in their material, and although this is not quite so important as in the plain joint, the same precautions are frequently necessary.

The *Candlesticks* and *Wax Taper holders*, figs. 651 to 658, ranging from about two to eight inches high, would with one exception, probably all be made of two pieces, the stem jointed into the foot. The longer stems when roughly reduced to shape would require the popit head to be exchanged for the support of the boring collar, fig. 128, while turning the cylindrical aperture to receive the metal nozzle. The stems are afterwards mounted by this aperture upon a plain wood chuck and again supported by the popit head, while their forms are completed and a pin turned at the end to fit within the base. Figs. 659 and 661, forms which would be turned in hardwood or ivory, would each be made of five or six separate pieces. Thus in the latter, the hollow vase for the taper would be attached to the tray beneath it, which may also receive the slender shaft by a separate fitting, the lower end of the shaft passing through the concave dish into the foot; or the upper end of the shaft, may in like manner pass through the tray into the vase.

These parts would be turned, the vase, as to its external and internal form, upon the end of a piece of solid material, cut off from which it would be reversed and mounted by the

lip within the rebate of a wood chuck, to turn either a pin to fit within the tray, or a hollow to receive the upper end of the shaft. The tray completed upon its edge, upper surface, and the marginal part of its under surface and hollowed to receive the pin on the vase, or pierced with an aperture should the shaft pass through it, while yet on the solid material, is then mounted by its edge and surface within a wood chuck, to turn the under central mouldings; some members however being generally turned upon the stem as a collar, to retain the tray in position and at right angles to the axis. The shaft would be turned carried by the square hole chuck, fig. 194, the prong chuck, or driven into a plain chuck and always supported by the popit head. As it becomes reduced in diameter it would require the support of the finger against the thrust of the tool, and in some cases, that given by fig. 139, or some of the other guides mentioned. Should no portion of the moulding be placed upon the shaft to prevent the descent of the tray, the upper end is reduced in diameter as a pin that the shoulder may fulfil the same purpose, but this method considerably reduces the strength of the shaft; the lower end in like manner carries a bead or moulding, not seen, or is reduced, that the shoulder may prevent the displacement of the dish. The latter is hollowed and turned as the tray; and the base, as many other preceding examples. Fig. 660, would have the shaft of a single piece fitted into its foot, and together with the figure above it, has separate portions inserted, the methods for which will be gathered from succeeding sections.

The *Vases*, figs. 662. 663, would be constructed, the former of either three or four separate pieces, the latter of four, and fig. 664 of two, inclusive of the stems, which are inserted in their pedestals. When of moderate dimensions and of uniform material, the pedestals would be turned from single pieces, or would at most require the addition of a second piece of larger diameter for the plinth; upon a larger scale, they would be built up of several parts fitted or screwed together. This construction is also adopted on the smaller when variety is sought, the shaft and plinth are then made of one, and the cornice and mouldings of another and contrasting material. The *Vases*, figs. 665. 666, precisely similar in the curves of their outlines, illustrate the effect produced by the reversal of the main form;

662.



663.

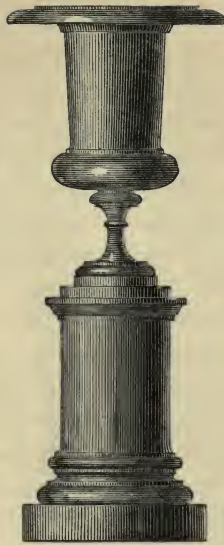

664.

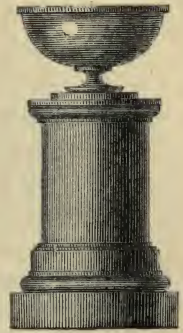

665.



666.



667.



668.

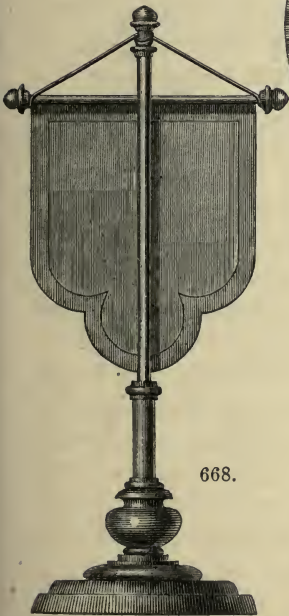

669.

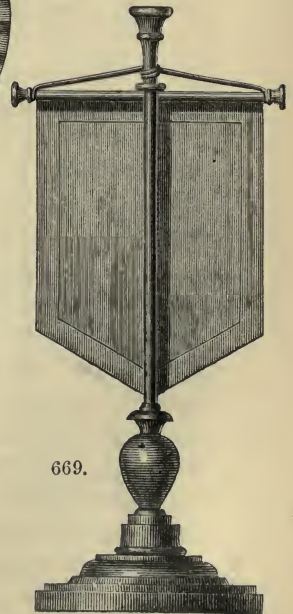

except when of large size, which would require the bell to be inserted, they would be turned from the solid. Figs. 662 to 666 would usually be turned in hardwood or ivory, but all as also many others among the examples, may be suitably produced in Cannel coal; a material easily turned, taking a high polish, and when finished undistinguishable in appearance from black marble. The mode of working this material and the tools employed, are given page 162, Vol. I.

The shafts and bases of the *Banner screens*, figs. 668. 669 about fifteen to eighteen inches high, would be turned from three or four pieces, and those of the *Candle shade*, fig. 667, from two; the slender cross rods, attached by silk cords, and the shafts, would require similar precautions in turning and fitting them together, to those lately described.

The outlines of figs. 670 to 678, reduced from *Etruscan Vases*, are intended to illustrate the characteristics and to indicate a few of the numberless varieties of curvatures, resulting from combinations of portions of the oval line. In these as in all forms derived from this source, ornament is markedly subordinate, their excellence arising solely from the balance and quality of the outline; for which and other reasons already alluded to, more instructive examples of form for plain turning cannot be advanced.

Viewing these figures as sections, in some the oval giving the main outline is axial, more generally, as in fig. 673, it is removed, the vertical or long diameter of the oval being eccentric and placed at an angle to the axis of the work. In nearly all portions of the curved outline are returned, that is, are alternately concave and convex, ovals of differing curvature and magnitude being usually opposed, but the one line always gliding into the other as a smooth continuous curve. Further variety arises from the vertical height at which the main form may be truncated by the lip, neck or foot, the outlines of which portions are themselves also contained by oval curves. The three central vases in which the oval outlines are not axial, also differ from variety in the ovals employed, both from the relative proportions of the large and small ends of the curves, and from the straighter or more rounded curvature of their long sides; differences common to the egg and all natural oval forms. Apart from the æsthetic

value of this last property, the exceeding variety that oval outlines will admit is particularly valuable in turning, meeting most accidents found in the material or arising from manipulation in the progress of the work; necessary departures from the predetermined form, so long as they harmonize with the character of the oval, always producing a true and agreeable contour.

Figs. 670 to 678, of small or moderate dimensions, may all be turned from single pieces of wood or ivory, frequently at a single chucking, the material mounted in metal plain chucks. With increased scale the support of the popit head is required; the material at first carried by the prong chuck, or fig. 286, and afterwards in a plain chuck, has its external and internal form turned true and roughly reduced somewhat to proportion, sufficiently to observe whether it will carry out the design. The hollow and the upper portion of the lip are then completed, and the work reversed and chucked by its aperture upon the fillet of a plain wood chuck, being adjusted to again run true before the popit head is brought up. All portions of the external form are then finished, the incised lines upon the body of the vase, the only approach to ornament, being finally cut in with a point tool. The vases are effective and serve many purposes when executed upon a still larger scale in hard or softwood, and the latter may be afterwards stained and polished. Of such magnitude they are constructed in several pieces, some joints occurring at the neck and foot, while others which have to be placed in the body of the vase, are concealed by incised lines, or some shallow moulding level with the outline.

671.

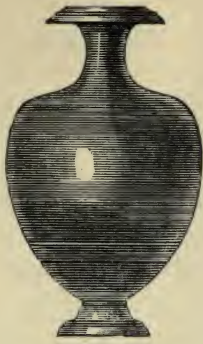

670.



672.



674.

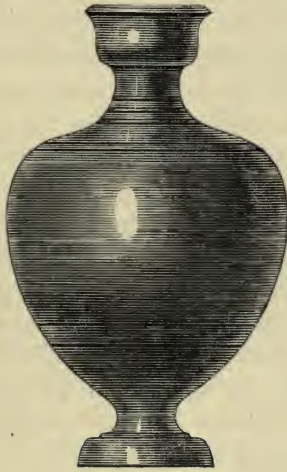

673.

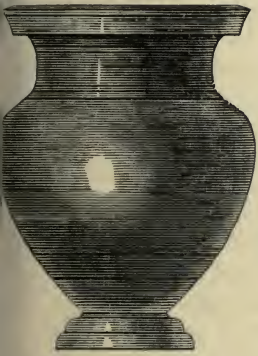

675.



677.



676.



678.

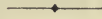

CHAPTER XIII.

PRACTICAL EXAMPLES OF COMBINED PLAIN TURNING, EXECUTED
WITH THE HAND TOOLS ALONE.SECTION I.—VARIOUS SPECIMENS OF MODERATE DIMENSIONS.
ATTACHMENT AND FORMATION OF COLUMNS, ARCS OF
CIRCLES AND OTHER ORNAMENTAL FORMS.

THE specimens described under this head consist either of main central figures, into which other portions are inserted eccentrically, or they have the main figure divided in several pieces, built up and connected by the other parts; in some few cases attached portions are cut out and shaped by other means than turning.

Those least removed from the works in the previous chapter, such as the *Watch stand*, fig. 687, about five inches high, in which the circular base and the tray above are connected by four or five short columns, have the additions parallel with their axes. All portions of this and of most of the succeeding examples, may be turned in softwood, hardwood, or ivory. The columns made from single pieces are nearly parallel, having mouldings at either end for the capital and base, beyond which both ends are prolonged as cylindrical pins for attachment. One column being first completed as a pattern, the remainder are formed of precisely similar dimensions, attained in each seriatim by first turning down the terminal pins to the same diameter, with the length of the remaining cylinder between accurately maintained; and then from that by measurements, turning the shaft, base, and capital to exactly accord with the pattern. The base and tray turned to form, they have circular lines struck upon the upper surface of the one and on the flat under surface of the other, to determine the position of the holes to receive the pins; the two circles being of precisely the same diameter that the columns may be vertical. That upon the base as the smaller piece is marked first, and sufficiently within the margin to prevent the foot of

the column extending beyond it ; the diameter of this circle is then exactly copied in striking the corresponding line upon the upper and larger piece. A lead pencil supported on the rest may be employed, when, should the dimensions of the second circle not precisely agree with those of the first, others may be marked within or without it, or the pencil may be slightly shifted so as to thicken the line until they do. The pencil would suffice for fig. 687, and its marks are easily removed with glass paper ; for greater precision, the compasses opened to the diameter of the circle may be employed as described upon the softwood surface ; and for nearly finished work, the pencil used to mark the circle under measurement is supplemented by a fine line carefully cut with a point tool ; but both the latter require the surface to be subsequently turned smooth to remove the lines, after the holes have been bored or their centers sufficiently marked. The two circles are divided into the requisite number of parts with the division plate, and marked across with the pencil or scratched with a line, page 126 ; and the work removed from the lathe, has the several centers carefully indented with a center punch.

In softwood, the holes to receive the pins may be made with an ordinary center bit ; the correctness of their positions being ensured if a fine hole be first bored with a wire drill or a small spoon bit in each center punch mark, for the guidance of the point of the center bit, all the bits being mounted in chucks and running truly in the lathe ; and the work held upon a parallel piece of board, being advanced by the flange of the popit head. The holes may also be bored in hardwood with drills running on the mandrel, but it is better for this material and almost a necessity for ivory, to mount the work upon a wooden surface chuck, page 240, that the centers marked may be successively placed in the axis of the mandrel and turned out to size with the hand tools. In all cases it is advisable to make the holes first, and then to slightly reduce the pins to fit them.

The amphora supporting the watch, in fig. 687, is in two pieces divided immediately below the head, which should be too large to pass through the bow ; the neck is hollowed to receive a pin turned in the solid with the head, which is withdrawn and replaced after the bow has been placed around the neck. The vase upon fig. 686, is of similar construction.

680.

679.

681.

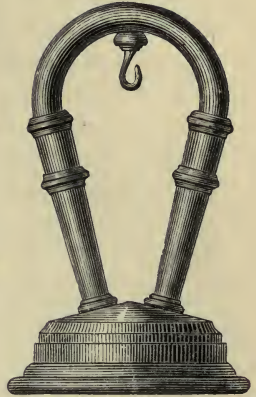
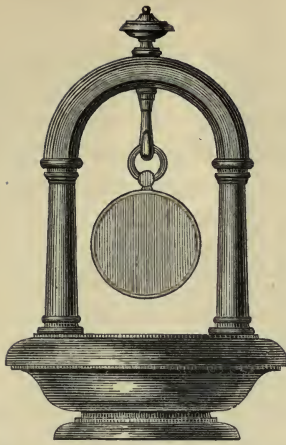

682.

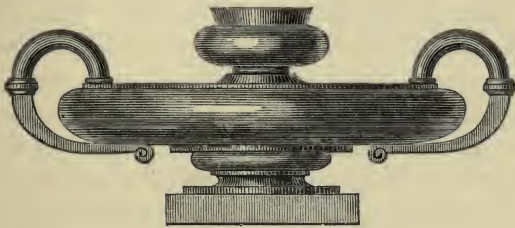

683.

684.

685.



686.

687.

This watch stand, as also fig. 682, has a square plinth, turned in the manner described in the succeeding chapter, and partially bored with a central hole to receive the pin for its attachment, which pin or external fitting is turned in the solid beneath the foot of the large vase.

Inclined columns, of which the *Watch stand*, fig. 684, about seven inches high, affords a small and fig. 747, a larger example, and all pieces so placed, may be variously attached to the surfaces they connect. Upon flat surfaces, as in the sections figs. 688. 690, the shafts are separate pieces, reduced at the ends. In the first figure the pins on the shafts are turned in the ordinary manner, having square shoulders and pass through the shaded piece, which may represent either the capital or the base, into the surfaces above or below. The separate capital or base finished to form but left solid, is then

Fig. 688.

Fig. 689.

Fig. 690.

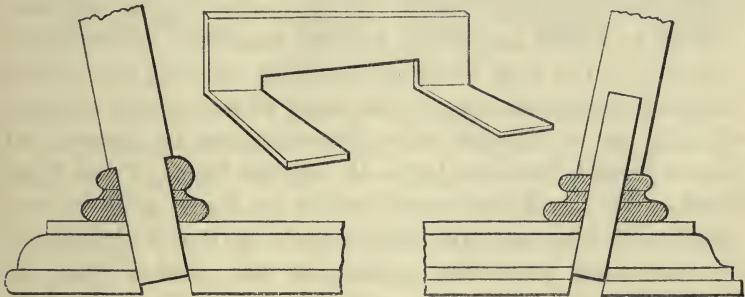

mounted centrally in the gap of fig. 318 or 319, held, the first, by its extreme upper and the last, by its under edge, the surface projecting beyond the front of the chuck, but parallel with it. One side lying in the direction of the opening of the chuck is then gently depressed, the work therefore rotating upon its diametrical line, until the face arrives at the required angle, as measured from the surface of the chuck; the screw or ring is then tightened, and the exposed face of the work reduced with a flat tool upon the arm rest, until it is again parallel with the surface of the chuck, and of sufficient diameter for the shaft. Similar angles upon all the pieces turned, may be ensured by first adjusting the work to a template, fig. 689,

having two long projections bent at right angles to lie on the surface of the chuck; equality in thickness being gradually arrived at, by frequent measurement of the edges of the different pieces through the gap of the chuck, as the face of the work is reduced. The work still in the same position then has a center made in it with a point tool and is pierced with a small drill, this hole being afterwards enlarged to the diameter of the pin on the shaft; all the turning on the surface and in the aperture, being carefully and gently conducted to avoid displacing the work. Work requiring more accuracy may be mounted axially, upon the sloping face of a wood chuck, fig. 321, this however is rather tedious for numbers, each piece having to be glued down.

The method shown by fig. 690, is neater and easier but less strong; both ends of the shafts are bored with parallel holes to receive separate hardwood pins, which pass through the intermediate pieces into the surfaces to which they are to be connected. The ends of the shafts are cut off at an angle, but this section being oval, the surfaces of the capital and base, have to be a little larger than its long diameter. These pieces turned to form, both surfaces remaining parallel, they merely require boring at the appropriate angle with a circular aperture the diameter of the pin; effected by interposing a tapering flat piece of wood between the wood and the flange of the popit head, or by turning the apertures at an angle, as described. Small and less accurate works, such as the *Watch stand*, fig. 684, may have the surfaces of the shaded portions, fig. 688, filed to the angle, and when the surfaces to which the inclined columns are attached are themselves conical, as in fig. 681, the mouldings remain at right angles to the shaft and are turned in the solid.

The positions for the holes in the surfaces of the two main pieces to receive the inclined columns, are marked out as for fig. 687. When drilled to size, the work is advanced by the flange of the popit head held on a tapering piece of wood, or when the inclination is considerable, upon two parallel pieces meeting at one end and more or less separated at the other by a third piece interposed, all three securely fixed together. When the holes are turned, the work is carried upon fig. 321, or upon a tapering lifting piece attached to a surface chuck;

being retained in position upon either, on an eccentric pin entering a central hole in the work, and fixed by clamps as described under the head of surface chucks.

The *Watch stands*, figs. 679 to 681, from five to six inches high, are usually made of hardwood or ivory, or with good effect as also in most of the combined examples, of hardwood for the principal pieces, with ivory interspersed for the enrichments and smaller portions. The arch connecting the columns is turned as a ring and may be of various sections; the piece employed, is first turned as a true cylinder within and without and its length reduced to its thickness, leaving it exactly

Fig. 691. 692. 693. 694. 695. 696.



square, to serve as a basis for more ornamental sections. During their formation, the ring is chucked in a wood spring chuck for turning its internal edge, and upon the fillet of a plain wood chuck, for reducing its two surfaces and external edge, being reversed from time to time, but always carefully placed in contact with the true shoulders of the rebates of either chuck.

For an octagon section fig. 692, the four corners are reduced with a flat tool until all the eight sides agree in width; the alternate faces may then be turned in hollows with a round tool, or as in fig. 694, an astragal bead may be turned on the center of every side of the original square. Among others the ring may be turned to a circular section, the latter, first as an octagon and then by continuously and equally obliterating the angles formed upon the system described for the sphere, fig. 431, until the circle is arrived at. This then serves as a gage to cut its entire surface into a series of small beads, side by side, fig. 696; the tool is presented radially to the circle, while those beads within the ring which cannot be otherwise

reached, are cut with an internal bead tool, fig. 401, upon the armrest.

The finished ring is cut across with a saw, rather more than half being employed for the arch; this is mounted in the spring chuck fig. 319, with first the one and then the other end adjusted centrally, the opposite ends projecting through the side of the chuck, to turn each surface flat, and parallel with the diameter of the ring. The arch is removed from the chuck from time to time, and the progress tested by standing its ends upon some flat surface, until the result proves to be correct. The exact center is then marked upon each end surface, which may be conveniently done with the sliding center, fig. 200, the arch reversed and held in the clamps of the vice; the distance between the two centers is then measured with the compasses and transferred to the base, to mark that with the positions for the two corresponding apertures. Replaced in the chuck, the arch has each center adjusted to run true, a straight edge placed across the two ends, showing that their two surfaces are at the same time parallel with the surface of the chuck; the ends are then pierced for plain fittings, or cut with internal screws to receive the pins turned above the capitals. When screwed into the arch, the lower pins of the columns are inserted in the base as plain fittings, but these are also frequently secured by turned screws, their heads countersunk in the under surface of the base, passing upwards into internal screws cut in the pins. The four little curved pieces for supporting the watch and chain upon fig. 684, in like manner are parts cut from a small ring, inserted in holes pierced in the moulding and in the little balls which surmount them.

The watch hook is first turned to the shape of a pear to obtain the outline, the upper end terminating in a little ornamented collar and a screw pin for its attachment. The opposite sides of the lower part are flattened and equally reduced to the thickness with a file; the internal line of the hook is then sketched on one of the sides with a pencil, and a large hole having been bored through the piece, to form the lowest portion of the internal curvature, the remainder is cut out with a piercing saw, fig. 714, Vol. II., or drilled with a series of fine holes, to be cut through with small files in finishing the hook

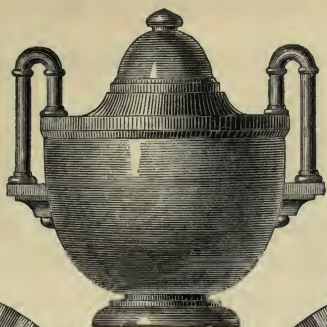

698.

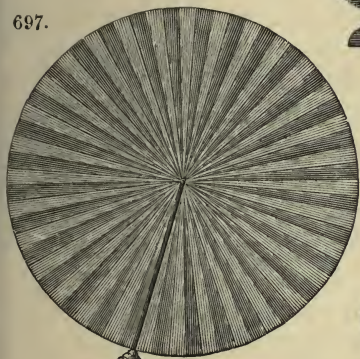

697.

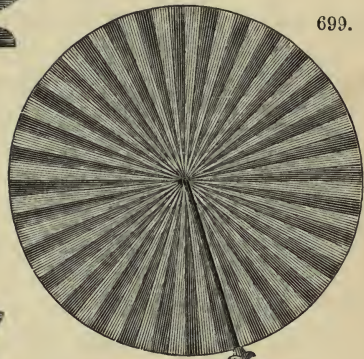

699.

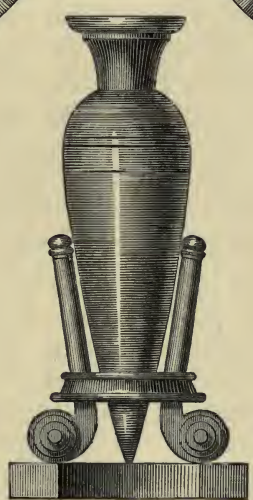

701.

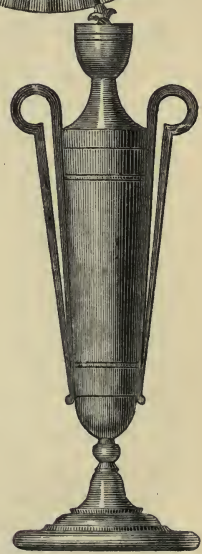

to shape. The hole to receive the hook, is turned with the arch adjusted centrally in the chuck, attained by shifting the work laterally until the two ends describe the same circle, the end surfaces being also tested for parallelism with the surface of the chuck to secure the hole being vertical; the latter, as in fig. 680, is sometimes bored completely through, a long screw on the hook then passing upwards into a terminal ornament.

The *Candle shade*, fig. 697, about ten inches high, has the stem supported on a tripod, formed of equal portions of a ring of square section; this, is marked and cut across in three places, parallel with its diameter for the upper ends, and radially in three others, for the lower. The upper faces of the arcs are turned flat, held in fig. 319, and pierced to receive small plain or screwed pins to attach them to the stem; the vertical faces are then turned flat, agreement in the lengths of the three pieces being ascertained by placing them side by side when out of the chuck; replaced in the chuck, the lower faces are turned slightly concave and bored to receive the pins of the terminal balls. Temporarily fixed to the stem, the three are stood upon their base to find the position for the vertical pins to attach them to it; the point of contact is marked upon the base and upon one arc, a circle is struck upon the former for the holes, and the mark is transferred from the latter to its two fellows by measurement. Every one is then returned to the chuck with the mark for the hole adjusted centrally, their flat upper ends abutting against the square flat bottom of the gap, or should that be too deep, against a parallel filling piece placed across it. Every piece being thus referred to a surface at right angles to the mandrel, to determine that all three holes are bored alike and vertical.

The *Inkstands*, figs. 682 and 701, are both three inches high. The first is composed of four pieces, the lowest being a square plinth, the handles are formed of semi-circles joined beneath by curved pieces, the former turned and of round, and the latter of tapering rectangular section cut out with the saw and file. The two halves of this handle are firmly connected and the joint broken by separate small beads, either surface of which carries a pin in the solid screwing into the two parts,

similar pieces attaching the handles to the upper surface of the main figure. Fig. 701, is of separate pieces above and below, fitting into each other and having external fillets, enclosing a flat ring, which is of a width sufficient to allow the insertion of the quadrants forming the three supports. The flat radial extremities of the latter are pierced with screwed holes to receive the feet below, and the screwed pins with hemi-spherical heads, passing through and securing them to the ring above. Shallow recesses may also be turned in the under surface of the ring to admit the ends of the quadrants; the ring when marked and divided, being mounted on a surface chuck to turn these and the holes for the screwed pins; the parts when polished being slightly glued for additional security, before they are finally placed together. The feet formed of cubes with ornaments inserted in their five faces, the similar central portion of the candlestick, fig. 656, and analogous rectangular parts in the other designs, being turned as described in the last chapter.

The handles added to the *Vases*, figs. 705. 706, are composed of semi-circles joined to cylinders, by pins turned upon the latter. In fig. 706, the plain circular section obtains throughout, the vertical portions being inserted in the body of the vase after passing through small circular ornaments, pierced at an angle, employed to conceal the joint. In fig. 705, the more numerous joints are broken by mouldings turned on the cylinders, the semi-circles being of square section attached to the vase by pins. The *Vase* fig. 698, about six inches high, has the handles terminated by brackets affixed to its sides; these may be also turned and then flattened on one edge to about a third of their circumference and hollowed to fit against the vase, or as in the figure, they may be rectangular cut out and shaped with the file.

The handles of the *Vases* figs. 699 and 702 to 704, pierced and cut out of thin flat pieces, are attached by pins entering holes drilled in appropriate positions in them and in the main figure; those shown are plain to agree in character with the vases they complete, but they admit of configuration when desirable and a variety of forms may thus be introduced, while the handles may be of the same or of another material to that of the vase. In the first and last figures, both about nine

702.



704.

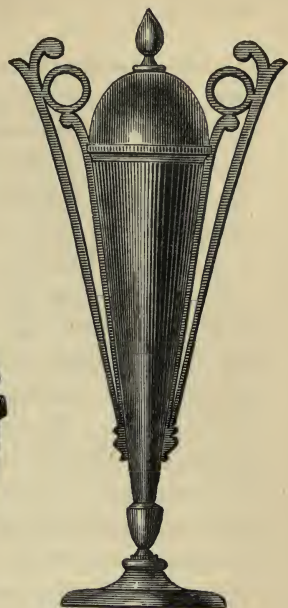

703.

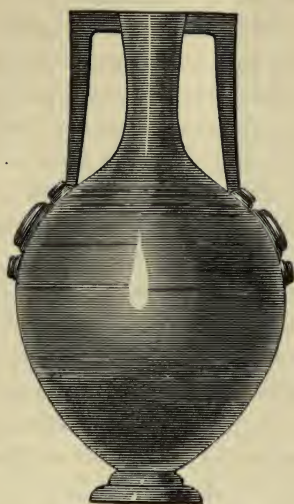

705.



706.



inches high, the handles are of single pieces gradually tapering both in width and thickness; two or three small hardwood pins attach one rib of the handle, the edge of which is slightly cemented when it is fixed to the vase. The pierced handles of fig. 702 are carved at the lower ends where one pin is placed, the upper pins have large turned heads and pass through them into the vase; similar heads being fixed upon projections left upon the upper ends of the handles. The more massive handles of fig. 703, cut out with the piercing saw and file, tapering also in thickness, the grain running vertically, may be notched into the lip, while below they terminate in pins entering the side of the vase, abutting also against inserted, turned ornaments which served to conceal the joint; other similar ornaments being added beneath. All the foregoing vases may be executed in such soft woods as pear tree or beech, and in hardwood or ivory.

The three uprights of the tripod supporting the *Amphora* fig. 700, one of which is omitted in the figure to avoid confusion, are made from flat pieces, somewhat the form of a letter L, to obtain a center in the line of the shaft to turn that cylindrical; the solid material replacing the clamp and pieces of wood shown in fig. 228. The shaft turned, the lower portions left of rectangular section are shaped by hand, and drilled with small central holes to receive the pins of their ornaments, formed as a series of steps, which are affixed to both sides. The shafts pass through holes bored in a ring which encircles the base of the vase, and are pinned below to the triform plinth.

The latter form, used also for the table of fig. 731, and the plinth of fig. 747, has the margin composed of three circular arcs, the points truncated by the original circular edge, and may be made of soft or hardwood. The piece is first turned circular and surfaced, being left rather larger than its finished diameter, after which the edge is divided and marked with three equidistant lines; it is then reversed, reduced to thickness, the under side surfaced and a small central aperture turned *partially* through it. Upon a small scale the under surface may be turned with the work held within a wood plain chuck or spring chuck; the edge and upper surface of larger pieces having been turned upon the screw worm chuck, or held

by a narrow portion reduced to enter a plain metal chuck, the under surface and aperture may be turned with the work glued down, or more conveniently, held by its edges upon a surface chuck, such as fig. 288. The work is then again reversed and mounted on a wood surface chuck, in which a pin fitting the central aperture is inserted on the diametrical line, at such a distance from the center of the chuck as will place the centers of the circles forming the arcs in the axis of the mandrel. The work is held down by clamps bearing upon its face and by screws passing through the holes made to receive the pins for the uprights; and it is shifted round upon the pivot to the three positions, at which the lines previously marked upon its edge coincide with a diametrical line marked upon the face of the chuck.

The dimensions of the arcs being struck on the face of the work with a pencil, each is cut completely through, rather within the pencil lines, with a fine parting tool, as described in reducing a piece of plankwood to the circle, page 274; whether the material be of softwood plankways, or of hardwood or ivory, the lengthway of the grain. The parting tool is followed by a right side tool or flat tool, held horizontally and advanced straight forward from the surface of the work to that of the chuck, the tee of the hand rest always parallel with the face of the work. The corner of the tool enlarging the arc to its finished size, turning it smooth and square to the surface. The chisel is used upon softwood, the blade held quite horizontally and cutting by the acute corner of the edge. From the intermittent cutting, all the tools require holding firmly, and advancing gently and exactly, both to turn the edge square to the surface, and to avoid splintering the external corners, an accident the more likely to occur at those where the work leaves the tool; and to recover which blemishes, the piece was originally left rather larger than the finished diameter. The edges of the curves may also be turned into steps or as a moulding, more easily with the tool cutting straight through from the surface than sideways; and the three arcs completed, the work is finally chucked to run true by its center, that the narrow portions of the original edge may be turned down to the diameter, and to agree with the profile of the arcs, which should also obliterate any splintering that may have occurred at the corners.

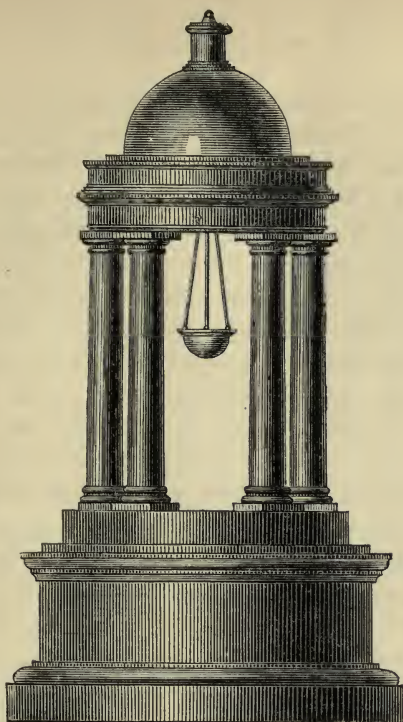

707.

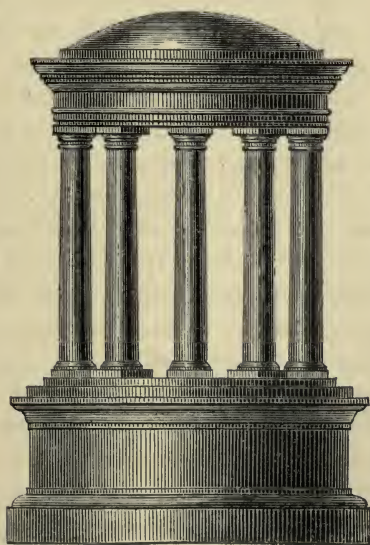

708.

The *Temples*, figs. 707 and 708, eleven and nine inches high including their pedestals, are constructed in hardwood or ivory, the first of four and the last of three main pieces, exclusive of the six and eight columns and the pedestals. The entablature and flat dome of fig. 708, would be of two pieces screwed together, which afford one example of a double fitting. The material selected for the entablature may be solid or a hollow. The former, has a narrow width considerably reduced to enter a plain chuck, and the latter, has its aperture turned true and the end surfaced, to mount it on the fillet of a plain wood chuck, the lower face of the finished form in either being that fitted to the chucks. The exterior roughly reduced to shape, the end is surfaced and the interior hollowed, leaving the work a ring, nearly the finished lower internal diameter throughout, or else for only a part of its depth, as may be more convenient to the mode of chucking adopted.

The end of the aperture of the ring, shown by the half section, fig. 709, is then enlarged to a depth suitable to the thickness of the dome, and cut with an internal screw for its attachment; the external face, and the narrow internal annular surface at the bottom of the screw, being also both turned perfectly flat under the guidance of a steel square. The work is then reversed and re-chucked upon a plain wood chuck cut with a corresponding external screw, the true upper face of the work and the true shoulder of the chuck in close contact. Should the internal cylinder not have been carried completely through the work at its first chucking, its length is now continued; and the edge of the external form being then reduced, as nearly as the internal to its finished diameter, the resulting annular surface is bisected with a circular line and marked across by the division plate and index for the positions of the holes for the columns. These are then bored or turned as plain fittings, or turned and cut with internal screws, the work carried on a surface chuck; after which, the work again chucked by the screw, the pierced annular surface, the external and internal form, and the mouldings of the entablature are correctly finished.

The piece for the dome, also first mounted in a plain metal chuck, has a portion at the end reduced in diameter and cut with an external screw to fit that within the entablature. This is made rather too long, but with its end surface and shoulder

perfectly flat. The length is then cautiously reduced by turning upon the end surface, repeatedly trying the screw in its place, until the end surface and that of its shoulder, both bear equally upon the two corresponding surfaces at either end of the internal screw; when, the surface fittings of the two pieces show no gap or interval viewed either from within or without. The double fitting shown by the section, fig. 711, is sometimes preferable; in this the upper end of the internal screw is turned away to form a true cylindrical recess in the face of the ring, the external screw then makes the joint by its flat end surface and the cylindrical edge of its shoulder.

The joint completed, the flat concave of the under side of the dome is hollowed and finished, leaving a margin rather

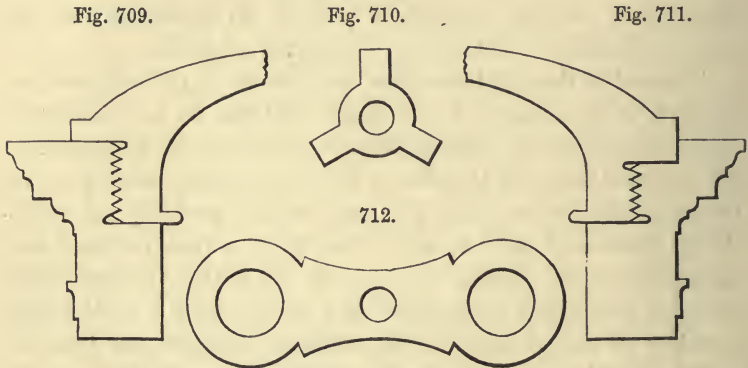

wider than that sufficient for the shoulder of the internal screw, so as to show a narrow soffit within the entablature; the edge being turned to a bead or moulding. The piece is then released from the chuck, reversed and mounted within a plain wood chuck cut with a corresponding internal screw, the two annular surfaces of the work and chuck in close contact, to turn the external curvature to the outline of a flat circular arc. The entablature, dome, and cupola of fig. 707 would be fitted together as three pieces; the plinth, the first piece in either temple immediately below the square bases of the columns, pierced with holes to receive their pins, being fitted into a recess turned in the face of the pedestal. The columns are turned after the same manner as those of fig. 687; they may be formed from single pieces previously planed square, but it is

713.

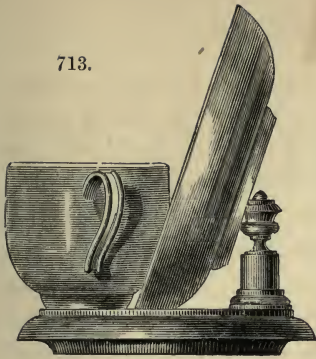

714.

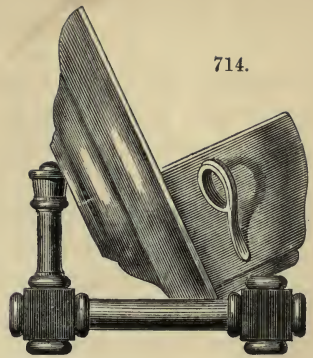

717.

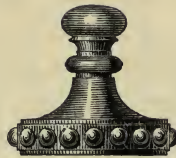
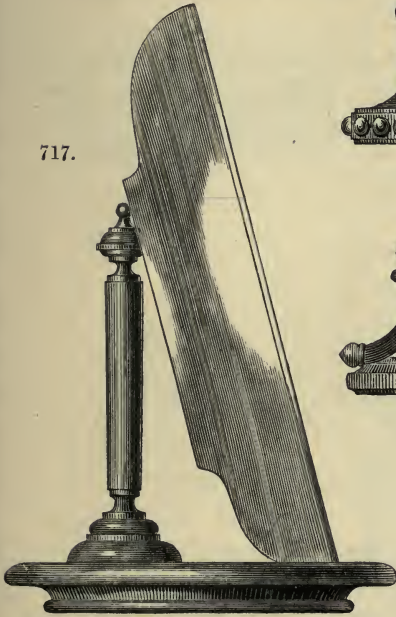

715.



716.

718.

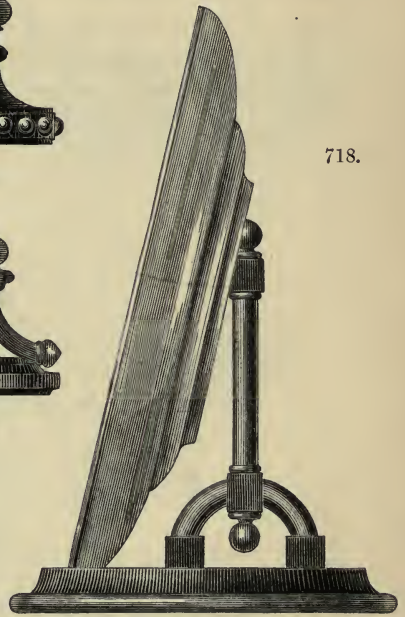

719.



720.

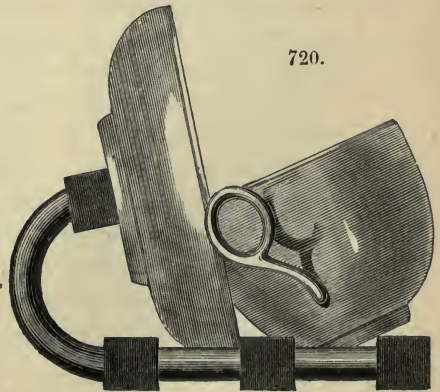

721.



722.

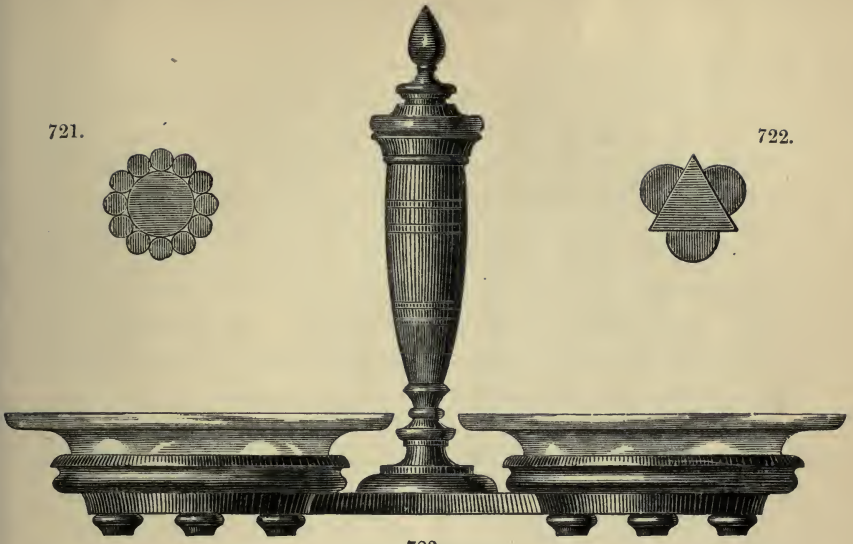

723.

725.



724.



726.

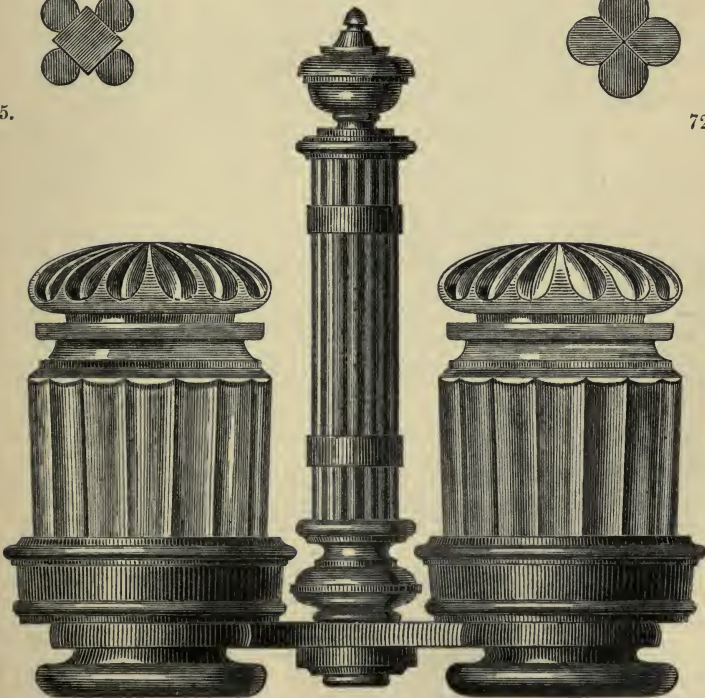

generally more convenient to place separate square pieces, pierced with central holes, upon the pins of the columns for the abacus and base. The mode of turning either is given in the last chapter, while it should be mentioned, that upon works of this character which pretend to some architectural proportion, all the mouldings but especially those which have to be exactly repeated upon the columns, are more accurately produced by the moulding tools mentioned page 298, than by any other means. The columns may be retained in their places by plain fittings both above and below; the best construction has the upper pins screwed into the entablature, the lower being plain fittings bored and cut with internal screws, to receive short turned screws passing into them from beneath the plinth or floor of the temple, both ends thus clamping the added square portions.

The complete works may be made entirely of one material, or the enrichments may be added in some other wood, or in ivory. In the latter case the dome, frieze, the shafts of the columns, the plinth and the dado or central portion of the pedestal, would be of one material, while the cornice and perhaps architrave of the entablature, the capitals and bases of the columns, and the cornice and plinth of the pedestal would be of the other. The entablature and the pedestal would then be each made of three or four portions screwed or fitted together, and the complete capitals and bases of the columns would be carried on the pins at either end of the shafts. When ivory is employed it is in the form of rings for economy, attached by plain fittings or cut with internal screws, either being finally secured by a small quantity of ivory cement. The rings cut off from within or without pieces of ivory in the course of their preparation, page 317, being thus available for many specimens of plain turning.

SECTION II.—SPECIMENS, GENERALLY LARGER AND FOR USEFUL PURPOSES. PLAIN TURNING APPLIED TO SURFACE ORNAMENTATION.

The construction of the *Menu holders*, figs. 683—685 and that of the *Stands for China*, figs. 713—717 and 719 requires no description, all the vertical pieces, with the exception of

that in the last, which is shaped by the piercing saw, being single pieces inserted in apertures pierced eccentrically in the base. The first of the *Menu holders*, figs. 715. 716, carries a series of small inserted hemispheres upon its lower edge, an ornament reverted to in later examples; both have a saw-kerf made through their heads to carry the card. The upright supporting the plate in fig. 718, is made of several pieces fitted together in the manner shown by many other figures described in detail; all the flat bases of the china stands have their surfaces recessed to form an edge, or when left flat, a deep notch, like that for the finger in a sliding box lid, cut across them, to retain the edge of the plate.

Fig. 714 is a square frame formed of four cubes joined by cylinders, the upright being inserted in the upper surface of a similar cube in the center of one transverse cylinder; these parts may be turned from pieces having an original square section leaving the cubes in the solid, or the cubes and cylinders may be jointed into each other, the ornaments being inserted in the faces of the former. The square frame work of fig. 720 has its three side cubes joined by two, and transversely, by three plain cylinders; the portion of a ring terminated by a cube serving for the support, being fixed to the face of another cube in the center of one of the external transverse pieces.

Table ware, of which figs. 723. 724, seven and nine inches high respectively, are useful examples easily constructed, admits great variety of form and purpose. The two glass saucers of fig. 723 are carried by shallow bowls which are attached by central pins turned beneath them in the solid, in apertures made in a flat piece of wood; the edge of which is shaped by hand into two circles connected by a straight or curved portion, as in the plan fig. 712. Three small turned feet are inserted in the flat piece at either end below, and the handle from above. In fig. 724 the glass jars are carried in a similar manner, the fittings turned beneath the bowls passing through the flat foundation plate and screwing into the circular feet below. The fascine handle is formed of several pieces, having a plain cylinder for its core, shown in plan fig. 721; the two ends of the core are reduced as screwed pins fitting into the flange of the urn and that of the base; a pin turned upon the lower end of the base passing through the foundation

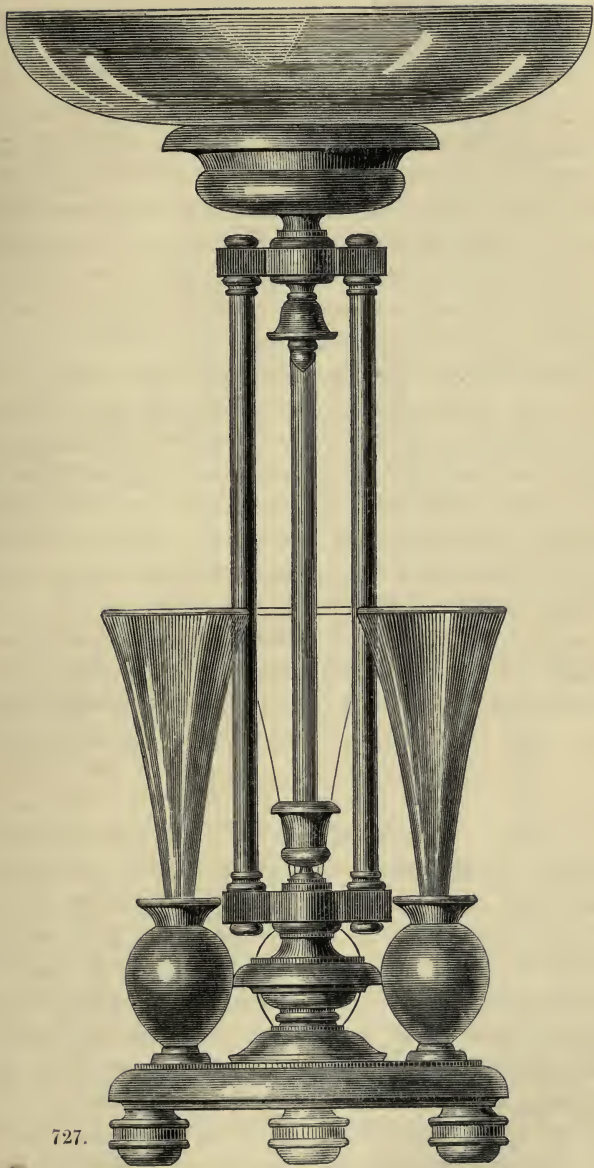

727.

plate and screwing into a fourth piece beneath. The reeds are separate slender rods, and have their extremities received in a shallow circular recess sunk in each flange; they are readily turned with the flat tool or chisel, the support of the left fore-finger placed around them from below, page 132, usually sufficing to enable them to withstand the thrust of the tool, but the support of the guide for slender turning, fig. 139, is sometimes desirable; all are made to the same length, diameter and parallel. The plain cylinder of the core is left rather too large in diameter and then reduced, until by trial, the sides of the reeds exactly meet when placed around it; then held in position by a string wound around them, they give the diameter for the recesses to be turned in the flanges, and for the rings which apparently bind the handle together.

Many beautiful varieties of clustered columns used for pedestals, furniture and chimney pieces, some of which are shown in plan by the diagrams figs. 722. 725. 726, are turned in a similar manner. In the last, the four pieces of the shaft turned precisely alike, are then planed away on one side to an angle of 90° , the shafts and their various terminal and other mouldings turned in one solid, then exactly mitreing. The pilasters in the other diagrams are separated by angular edges, obtained by planing flats on one side, for their attachment to a triangular or rectangular core.

The *Epergnes*, figs. 727 to 729, carrying glass or china bowls, and from fifteen to eighteen inches in total height, are more elaborate, but only from the greater number of parts of which they are composed. The circular base of the first stands upon three feet, and carries three vases holding flower glasses surrounding the central form, which touching the vases to give stability, is surmounted by a flat circular piece having three projections to receive the vertical shafts, shown in plan fig. 710; above which a little vase is attached to complete the lower axial figure. The upper extremities of the shafts, are received in a similar piece beneath the tazza.

The triformed piece, fig. 710, is first turned to thickness as a cylinder, flat on both faces, of a diameter sufficient for the length of the projections, and pierced with a plain central

aperture for its attachment to the vase or base. Then chucked by the central aperture, a circle is marked on the face to give the positions for the holes for the shafts, and a second circle marked within this, the diameter of the arcs between the projections. The outer circle divided by the division plate, is then marked with three equi-distant radial lines, continued to the margin and marked also along the cylindrical edge, that the piece when reversed on the chuck may be adjusted to have corresponding lines and circles scribed upon the under side. Removed from the chuck, the intersections of the outer circles are indented with a center punch, and are then bored or turned with plain holes to receive the pins of the shafts. Subsequently both surfaces are marked with lines on either side of, and parallel with the first three, for the projections,—the forms of which may otherwise be contained by radial lines, circles or other curves as determined,—to serve to guide the saw in cutting away the superfluous portions between; the exact shape being finished to these lines and the arcs of the circles, square to the surface, with the file. The shafts, which have precisely similar mouldings at either end, are secured in their places by turned screws with ornamental heads, passing into them from above and from below.

The central form of fig. 728, is composed of several pieces, the tazza at the summit, its neck, the overhanging piece carrying the arms, a circular core, surrounded by short cylinders contained between two flanges, and the pedestal, in which the cornice, dado, plinth and columns are also separate. The little cylinders are retained in their places in the same manner as those of fig. 724; the core being turned in the solid with one flange and fitted or screwed into the other. The ends of the lower tier of columns, are received in apertures made around the cornice and plinth of the pedestal, so that both these latter cannot be screwed into the abutting portion of the main figure; the plinth is attached by a large screw fitting turned in the solid upon its upper surface, the cornice has a plain fitting and is secured when the columns are in position, by a screw turned upon the piece of the stem above passing through it into that below. The smaller china bowls are carried upon tazzas, repeating the form of that for the center, supported by arms formed of cylinders attached to semi-circles. The rods

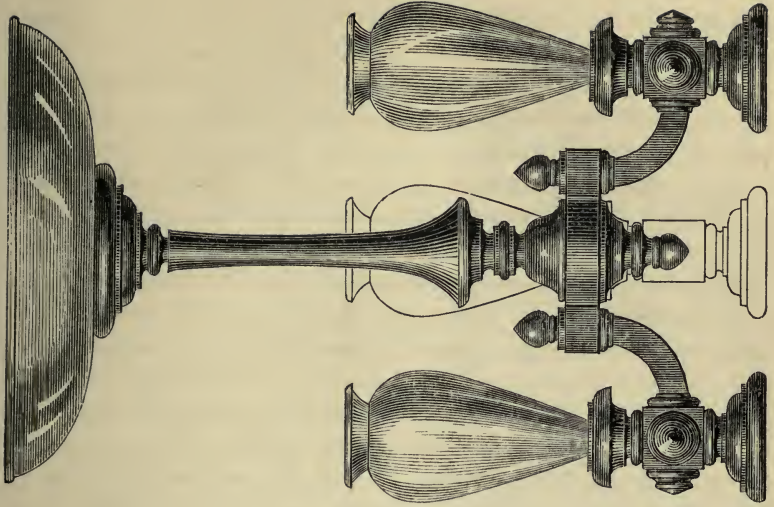

729.

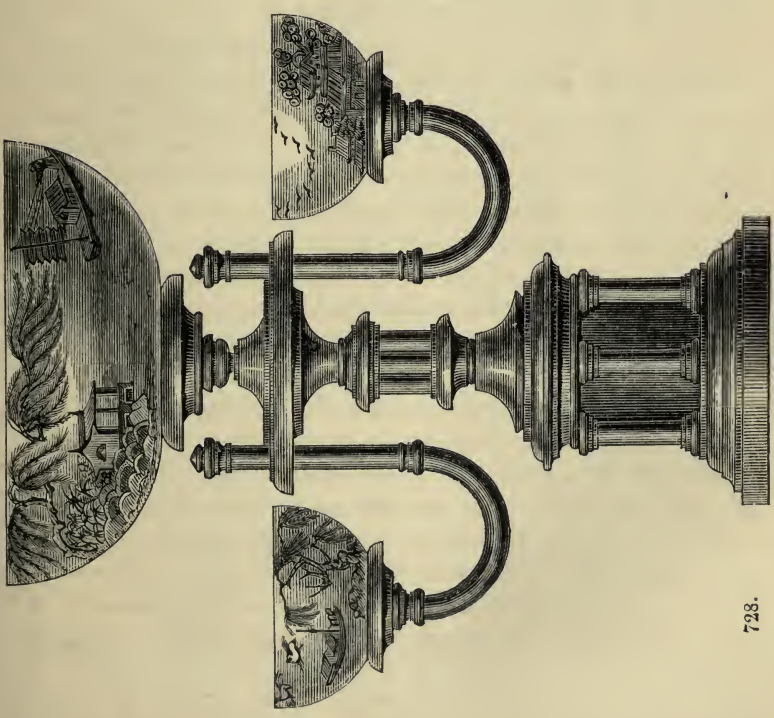

728.

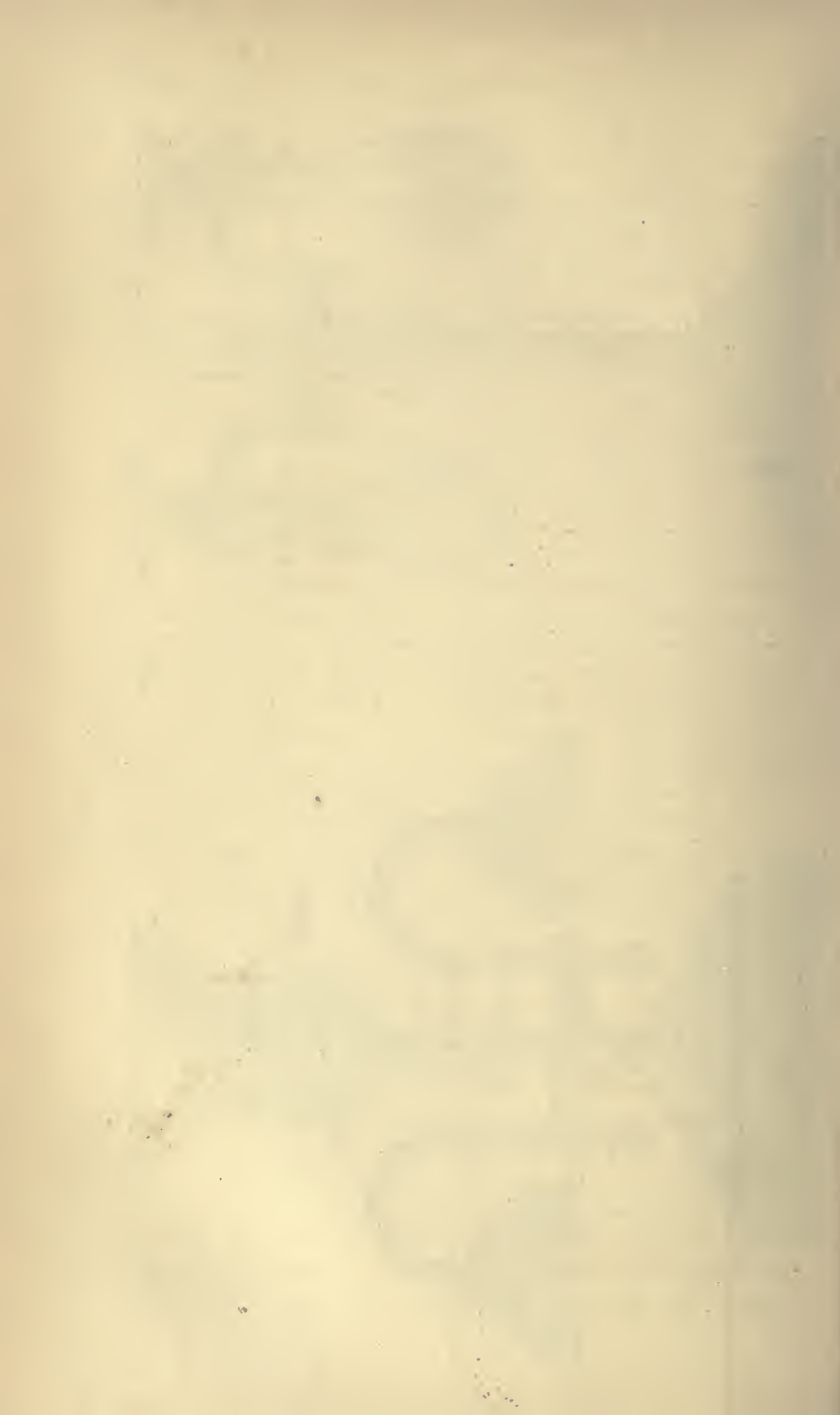

are in two pieces, the lower having a shoulder and a plain fitting of slightly reduced diameter passing through holes made in the edge of the overhanging flange, and terminating in screws to receive the upper portions which secure them in position. Wood or ivory rods of very small diameter employed in this manner, may be strengthened by enclosed brass wires; the shaft is first bored with a pipe bit, page 310, and reduced to external diameter after the wire is inserted. Only two branches are drawn in fig. 728 to avoid confusion, but they may be three or four in number, when the latter, the vertical portions may be of additional length in the one pair, so as to place the bowls at different levels.

The shaft of fig. 729, passing through a flat plate of the form already described, and secured by an ornament screwed on it from below, is of a single piece; the three feet formed of cubes with the other portions inserted in all their faces, being attached by quadrants of square section, terminating in little separate turned collars, and secured to the projections by screws with ornamental heads from above. All parts repeated in the foregoing examples are turned consecutively, both for convenience in chucking and to more easily arrive at uniformity in their several dimensions.

In the *Flower-pot stand*, fig. 731, fourteen inches high, the three uprights may be turned from single pieces squared at the ends, which terminate in pins, or carry inserted hardwood pins, to secure the flat table and the curved feet; the latter, formed from rings of square section. The uprights are connected together and retained parallel, by a circular plate and short transverse pieces below. The flat top is turned circular held upon the screw worm chuck, after which the arcs are hollowed in the margin, leaving small intervals of the original edge. Upon a reduced scale the arcs may be turned cut through from the surface, as with fig. 700, but in the larger example under consideration, they are more conveniently cut out with a turning saw, fig. 710, Vol. II., and finished with the file and scraper to lines previously marked upon both surfaces. On account of its size, fig. 731, would probably be turned in mahogany or other softwood, which may be afterwards dyed if desired; and for the same reason, the lifting blocks, page 180, would be required for its production in a five inch center lathe.

This stand and some other examples just touch the application of turning to furniture, a branch of the art however, which in its elegance and usefulness comprehends too universal a range for more than mere allusion here.

The *Wall Mirrors*, figs. 730. 732, about sixteen inches in total height, are simple examples of numerous works constructed of turned pieces, flattened on one side and attached from behind by ordinary joiner's screws, to flat wood backs or foundations shaped out to the same outline. The inner edges of the turned work may extend over those of the central aperture in the back, to form the internal rebate to carry the glass, which is secured in position by a second thin plate of wood screwed down to the other side of the back. This is unsuitable to turned work of inconsiderable width, such as the arch of fig. 733. The entire aperture is then cut out to the inner profile of the assembled turned work, and the glass, rather larger than the aperture, is laid down on the other side of the back; being retained in position by slips of wood, equal to it in thickness and placed around as a frame to form the rebate; the whole being covered by a thin plate of wood the size of the interposed frame. The turned portions forming the entablature, base and pendant of fig. 730, finished and polished while still circular, are then cut through parallel with their diameters by the saw, and their flat sides finished with the plane and scraper; the parts employed being considerably more than the semi-circle, for better effect and for the larger to also serve as brackets. The pins of the columns are inserted in the ordinary manner, the flattening of the shafts and mouldings leaving them intact; the arch above being rather more than the half of a ring, and having a circular rebate turned in its under side to receive the upper piece of glass. All the parts are tried together as they are produced on some flat surface to ascertain that all are reduced to one level, they are then laid down upon the back, a flat piece of mahogany, slightly glued to it at intervals with pieces of paper interposed between the glued surfaces to retain them in position while the holes are bored through from behind, and all the screws inserted. The outlines being marked all around them, all the turned work is removed, that the back may be cut out to shape, if necessary dyed, and polished, after which the parts are finally fixed



730.

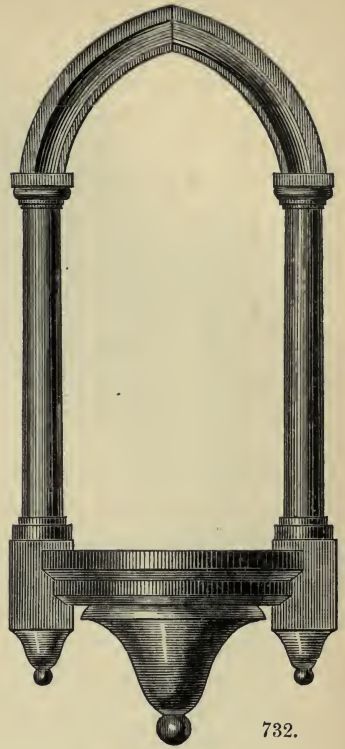

732.

731.

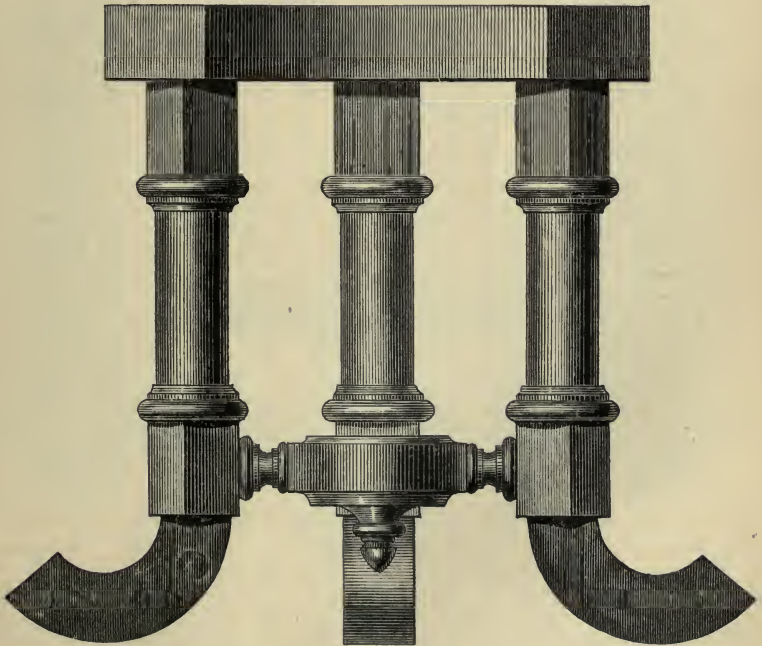



733.

together. Fig. 732, constructed in the same manner, has the bases of its columns left square, and its pointed arch formed by two portions of a ring.

The more ornate example, fig. 733, drawn from a finished work twenty two inches in total height, shows the back, of which the upper portion is shaped out as part of the design. The external frame turned in cubes and beads from pieces of square section—for which, see the concluding chapter,—has the vertical lengths terminating in pins, inserted in the slightly larger terminal cubes of the similar horizontal piece, and in the circular pendants below. The latter join the ends of the plain horizontal bar, the center of which, left square, is attached by screws to the flattened side of the base of the lower tazza, which base also carries the central pendant; these parts are all flattened only so far as necessary for their attachment to each other or to the back, except the bowl of the tazza, which is divided parallel to its diameter to rest in contact with the surface of the glass. The upper tazza and its pendant are left circular, except the largest diameter of the latter, which is flattened, and fixed by screws to the square center of the horizontal portion of the external frame. The ornament above is of three pieces; the columns have pins at their lower ends passing into the side pendants, above they are flat, and meet the end surfaces of the half of the large ring forming the arch. The arch and some of the larger portions are turned in mahogany, dyed black and polished to agree with the remainder of the work, which is of African black wood or ebony.

The central enrichments of the spandrels, flat discs ornamented by sunk eccentric steps and mouldings, and attached by a central pin in holes in the surface of the foundation plate of the frame, are the only portions requiring description. To about three inches diameter, such pieces may be turned upon a wooden cement chuck, having a short and fine central wire, as described page 239. The discs are first turned to the required diameter and thickness, flat on both surfaces and their external margins to a moulding; the centers for the trefoils, figs. 734. 736, are then marked on the under surface, and a fine hole made in each center for the wire of the cement chuck. Attached upon the chuck with the central wire in one of these

eccentric holes, the first of the three circular forms composing the ornament, indicated by fig. 736, is turned in the face, sunk as a series of steps and mouldings each below the other, the center being turned as a flattened hemisphere standing upon the deepest flat surface. This completed and polished, the disc is released and replaced upon the chuck, with the wire in a fresh center to turn the second. The first then serves as a gage for depth, as the tools cut across its steps and mouldings in repeating them in the second; while the central hemisphere of the first being below their level, remains untouched by the tool in turning the larger diameters of the second. The third leaf intersecting the two previously turned, completes the figure. In fig. 734, and in the quatrefoil, fig. 738, the lower circles cut across the center, in these therefore and in that

Fig. 734.

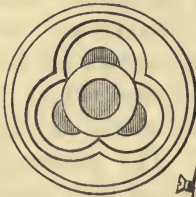

Fig. 735.

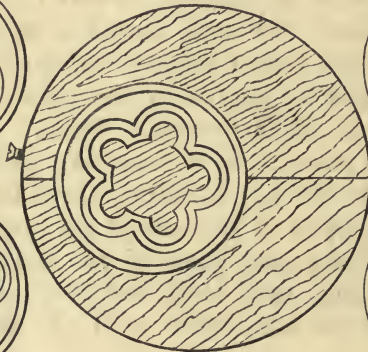

Fig. 736.

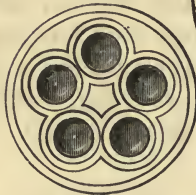

Fig. 737.



Fig. 738.

employed in the mirror, the central ornament is inserted, its pin passing through the disc into the form to which it is to be attached. The leaves of the cinquefoil fig. 737, have central concaves, while the circles of their margins leave portions of the first step; the central portion thus left, may if desired, be subsequently turned down to the general level with the work mounted centrally.

Work of increased size is turned more safely, when carried in a cavity sunk in the face of a wooden surface chuck, fig. 735, a method more facile and exact. The wood surface chuck

is first turned true, mounted centrally on a screw worm chuck having a large flange, and coincident diametrical lines are marked across its back and front; a hole is then bored on one line, so far from the center of the chuck, as the distance between the center of the disc and the centers of the series of eccentric circles to be turned in it. The surface chuck mounted by this hole upon the screw worm chuck, then has a flat eccentric cavity, the depth and diameter of the work, turned in its face; after which it is replaced for use with the screw in the original central hole. The work, divided with lines upon its margin into the number of leaves required, is placed in the cavity, with one of these lines agreeing with the diametrical line on the front of the chuck, retained in position by either one or two screws, usually joiner's wood screws, which pass through the edge of the chuck and that of the cavity, to slightly bear upon the edge of the work. One complete form being turned in the work in the manner previously described, the others follow, the screw being released and the work refixed, with every mark in turn against the line on the chuck; or which is sometimes more convenient, the forms may be gradually produced, the upper mouldings being completed at every center before proceeding to turn the lower. The cinquefoil represented on the chuck, has had the disc subsequently mounted centrally, held by its edge, and the center cut through, leaving it a ring. The ordinary flat and other hardwood tools are employed, held horizontally and advanced gently, so far as possible always cutting straight forward from the face, the rest placed across the surface of the work. A narrow flat tool keenly sharpened upon both sides and the end, is used to remove the bulk of the material, widening and deepening the grooves a little at a time; this tool shapes all steps and surfaces, leaving the edges and faces sharp and cleanly cut, it is followed by tools of other forms for those parts to which it will not apply.

The chuck fig. 735 is also employed for inlaying, an analogous surface ornamentation admitting considerable variety, and applicable to either large or small work. Eccentric circular grooves and apertures with nearly upright edges turned in the surface of the work, are filled with corresponding turned rings of some different material, cemented in their places; after

which the whole is turned to a surface and polished. The narrow flat tool used is of less width than the grooves, which are gradually widened to their dimensions, cut in always from the face by their external and internal diameters. Of the six varieties indicated, that formed by rings, fig. 739, is most readily produced; every alternate circle is turned in the face of the work, they are then filled by their rings, and then with the work mounted centrally, these are turned down level with the surface. The remaining circles are next turned, intersecting the first, and filled with a similar or contrasting material, the work being then finally surfaced and polished. The discs forming the second pattern in this figure, are inlaid in corresponding recesses, every one except the first being cemented as

Fig. 739.

Fig. 740.

Fig. 741.

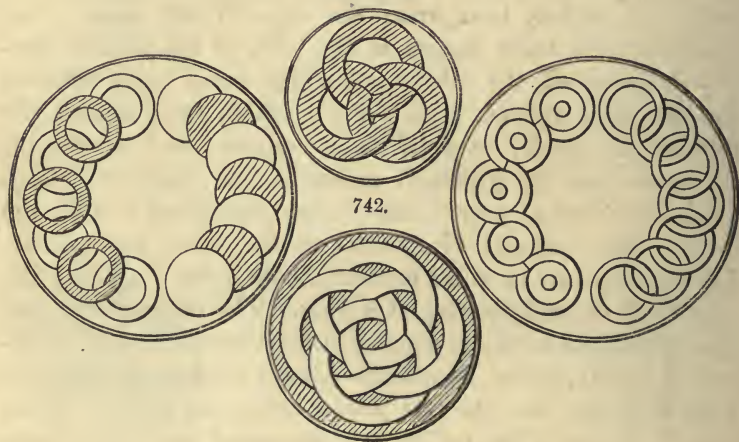

it is placed in, and then partially turned away in sinking the next recess. The first disc, has to be withdrawn to turn the last recess, and the arc for its neighbour has also to be turned in its side.

The rings forming the patterns in fig. 741, are cut across by hand into two series of similar pieces, previously to their insertion, while those in the remaining examples are more and unequally divided; all the grooves being sunk in the face of the work before any portions are inlaid. Similar inlaid patterns may be wrought upon cylindrical edges and in straight lines upon planes. For the former, the recesses are turned

743.

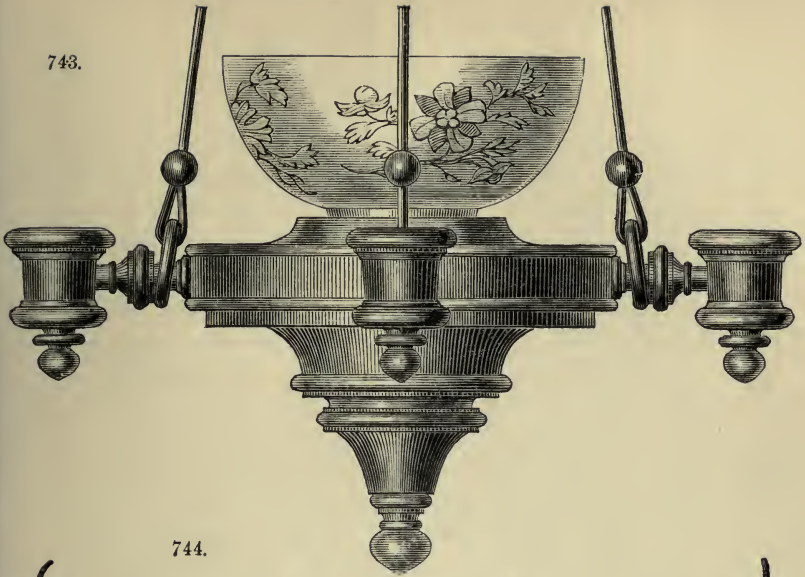

744.

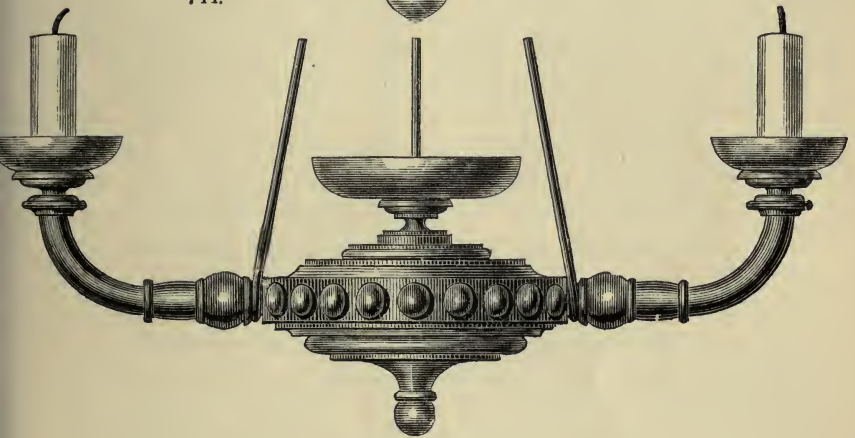

745.

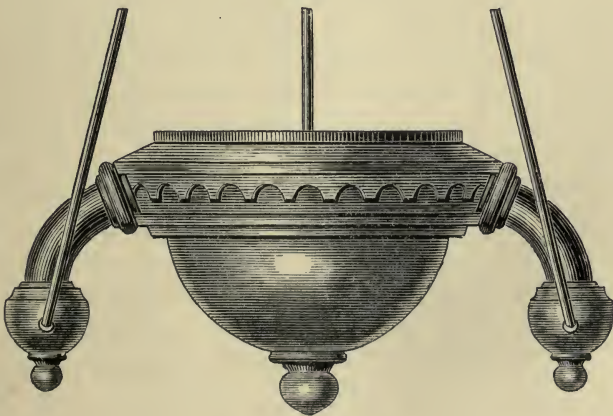

with the work mounted according to its size and terminal formation, in some of the upright chucks previously and subsequently described; the narrow flat tool used as before being advanced with increased caution, required by the intermittent cutting at the cylindrical surface edges of the recesses. Rectangular pieces, having first had the positions for the various centers marked upon their flat sides, are clamped down to a wood surface chuck, placed and shifted along against a straight edge, page 246, fixed to the face of the chuck at the requisite distances from its center.

The *Chandeliers*, figs. 743. 744, both contain a flat circular plate as the main piece of the entire structure, the upper and pendant portions being inserted in the surfaces, and the branches, three or more in number, in its edge. When the edge is bored, the work held in the hand is advanced to the revolving drill by the point of the popit head; for three or five branches therefore, the edge previously marked with a central line has to be divided into six or ten parts, so as to place every successive aperture radial, in a line with the mandrel. A fine hole is first bored in this manner at every position for the better guidance of the following larger drills, and the point of the popit head; those intended for the arms, are then gradually enlarged to size, while the remaining holes may also be increased in diameter to receive small projecting ornaments, as in fig. 744, which carries a series. When more accuracy is required, the piece is clamped upon fig. 320, or upon some analogous chuck, the apertures may then be turned as plain or screwed fittings. The arms are passed through metal rings for the supporting cords or chains. The cylindrical edges of either example are appropriate for inlaid ornament, while the inserted hemispheres shown upon the one, might be turned upon the solid material, as in fig. 755, a method employed for similar but bolder pieces.

The *Hanging Jardinière*, fig. 745, which is formed of several pieces and is five inches high, presents no peculiarities undescribed, except the serrated edge of the central plate. This may be added to it as a large ring, turned to the taper and abutting against a shoulder left at the upper edge; the pins

attaching the three arms passing through its semi-circles. The ring for this purpose, reduced to the finished thickness, but left considerably too wide and fitted on a temporary wood core, is first divided into the number of parts required, and marked with the center punch. Small holes are then drilled at every center to guide the point of the center bit, which is used running in a chuck to bore a series of circular apertures completely through the ring, the work being advanced by the point of the popit head. These completed, one edge of the ring is turned away to the marginal width, and the ring still upon the core, is then divided through the diametrical line of the circles with the chisel, held and used upon its edge as in turning the surface. The taper serrated edge may also be turned in the solid; the piece then left of more than sufficient height, has the series of circular recesses turned in it with the flat tool, the work carried on a central pin and clamped to the sloping face of a surface chuck, or, mounted in fig. 755. The chisel is next employed, with the work mounted axially, to divide the circles as described; and the lower halves are then turned down, to the depth to which the recesses have been sunk; the edges of the plate being subsequently turned to shape. The larger parts of all three preceding examples would be turned in softwood, to be dyed and polished to agree with, or in contrast to, the other portions.

The methods of turning most parts of the *Candelabra*, fig. 746, twenty-two inches high, will be gathered from preceding examples. The six or eight branches, formed of halved rings connected by pins or screws on interposed collars, are inserted in the edge of a central piece; a similar formation obtaining in the tripod foot. The stem extending in a single length from the one to the other, is inserted in the amphora, which latter is secured in the circular base; the surrounding spirally arranged leaves, being turned in the solid with the stem, as a series of cups of the profiles and at the distances required. The width of the part of every cup to be left to form the leaf, is then marked upon every one with a pencil, and the stem still supported between centers, has every cup cut through these lines with a tenon saw, in a line with the axis and down to the central tapering rod. The major portion of every cup is then pared entirely away with a carpenter's chisel, until the



746.

space it occupied becomes a part of the central stem; the square sides of the narrow portions remaining, being finally finished to shape with the chisel and file.

The *Tripods*, figs. 747. 748, are adaptations of *Pompeian pedestals*. The first, a *Table lamp stand*, fourteen inches high, has three supports braced together by square diagonal pieces connected to central rings; one side and two shafts only being shown to avoid confusion. The shafts terminating in pins, pass at an angle through separate capitals and bases, by one of the methods figs. 688. 690, into apertures bored in the surfaces of horizontal quadrants, cut from circular pieces, turned to the required profile; the flat sides of the latter being enriched by inserted ornaments, formed by a series of turned fillets. The upper and under surfaces of the quadrants are connected to the vase above and the feet below by vertical pins turned in the solid upon interposed collars. The feet are cut from a ring turned to the profile, the flat surfaces of their sides receiving similar ornaments to those above them; the foundation plate being of the curved triform plan already described. The diagonal bracing, principally required to give character to the design, is formed of pieces of square section, the ends of which are turned with cylindrical mouldings and pins, inserted in appropriate apertures made in the quadrants and in their central connecting rings.

The second *Tripod* to support a *lamp, statuette, or flower vase*, stands on the floor and is forty-eight inches high. The long uprights again terminate in pins, which pass into the crescents above and into the quadrants below; both formed from rings turned of square section. Turned from single pieces the shafts would probably require the lengthening bearers, fig. 185, but they may also be each made in two lengths joined in the central ornament; one length having an aperture in the end, turned with the piece supported in the boring collar, and the other, provided with a corresponding pin; the method that was adopted in constructing this specimen. The shafts are connected and strengthened towards their lower ends by a central disc, to which they are attached by screwed pins with ornamental heads, passing transversely through them; the upper and lower surfaces of the disc carrying a vase and a pendant ornament. The lifting blocks figs.

182, 183, would be required to turn the circular plate, fourteen inches diameter, connecting the lower ends of the feet. The vase and its pendant at the summit, is formed of three or more pieces as may be convenient to the material; the pendant being attached by horizontal pins, passing only partially through the three crescents and therefore concealed. The portions of square rings forming the latter, have the two holes for these and the pins of the shafts, bored in exactly similar positions in all three, and their radial surfaces are also pierced with apertures to receive the terminal ornaments.

In concluding the description of the specimens of plain turning contained in the foregoing chapters, it should be noticed that in copying from designs or existing works, it will frequently happen that the reproduction has to be executed on an increased or diminished scale, in order that the copy may agree with the height or diameter of some particular piece of material to be employed. The exact and relative proportions of all parts of the design then requisite, may be readily ascertained by mechanical assistance; the most familiar being that afforded by *proportional compasses*.

By means of its sliding center the one end of this instrument may be arranged to measure, say, one and a quarter, two and a half, three times, or other proportions of that shown by its opposite points; and in this manner the shorter ends of the compasses being adjusted to the height of any of the foregoing figures, while the longer agree with that of the piece of material selected, all the measures then taken on the original with the former, are equally increased by the latter, and the form may be delineated in accordance upon paper, before commencing the work. *Proportional callipers* which resemble the callipers, fig. 342, but have the legs terminating in points, and the center moving and fixing to different positions along them, are still more convenient for the purpose. The pointed ends are used to measure the design, while with the calliper bows, the increased measures can be directly applied to the length or diameter of the work in progress.

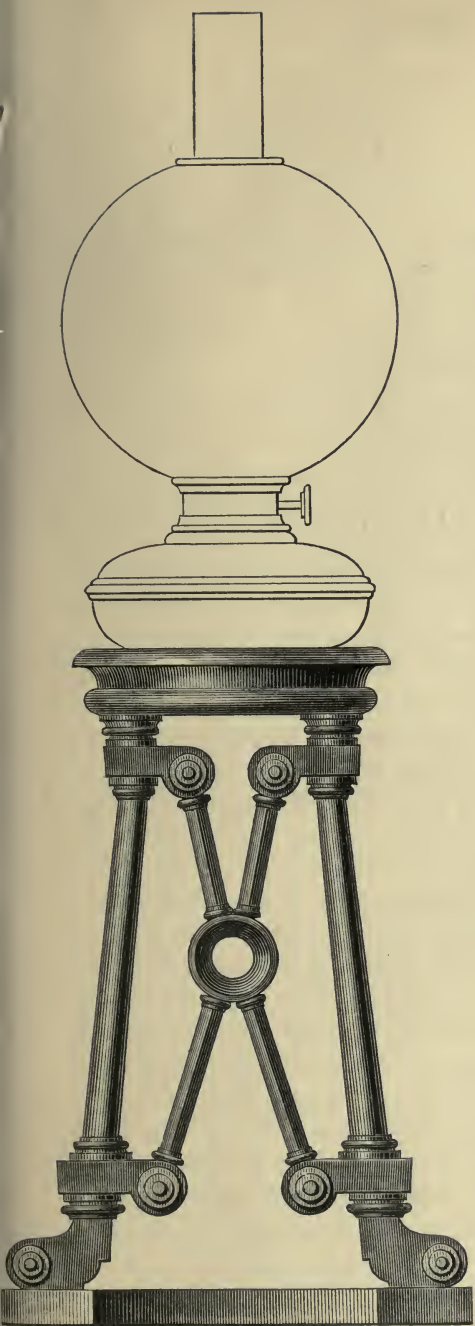

747

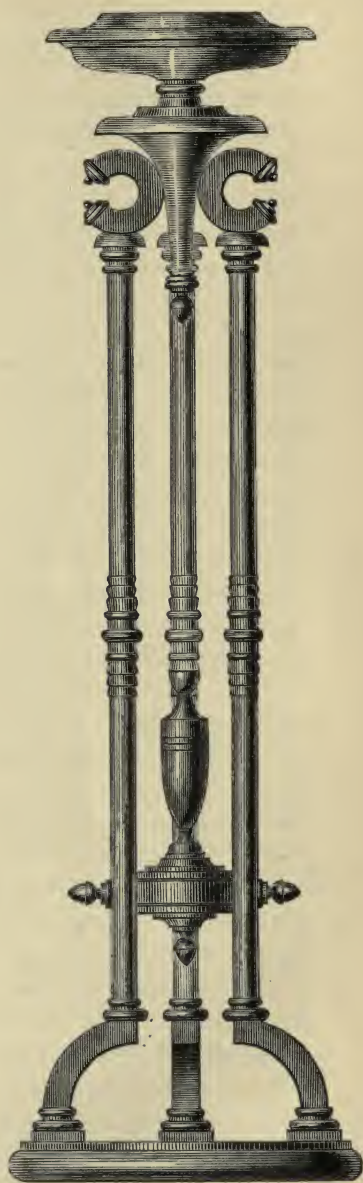

748.

CHAPTER XIV.

MISCELLANEA IN PLAIN TURNING IN WOOD AND IVORY.
DYEING, STAINING, AND DARKENING.



SECTION I.—MISCELLANEA.

PORTIONS OF THE WORK LEFT OR TURNED RECTANGULAR.
CUBES.

THE interposition of the square with the circular section, variously adopted in several of the preceding examples, is frequent in plinths and shafts turned in the solid material, and familiar in table legs and balusters; which, first planed to their square section are then turned circular at the required intervals. The end surfaces of the square portions are usually at right angles to the axis of the work, they are turned with the chisel in either hard or softwood, and the circular portions lying between are subsequently reduced to form with tools appropriate to either material. This formation, being that employed in the external frame of the mirror, fig. 733.

The surfaces of the two extremities of the square shaft, are first carefully divided by diagonal lines from the corners to find their centers, and the piece is then mounted by these centers between the prong chuck and the point of the popit head. The chisel is presented to the work held upon its edge, the obtuse angle beneath, as in fig. 348, but with the tee of the rest fixed rather lower to increase the vertical angle of the blade, the cutting edge just out of contact; in the other direction, the one or the other bevil of the cutting edge is held at right angles to the axis of the work, as a right or left hand surface may be under formation. The handle is slightly raised to make the first incision, which takes effect only on the square edges of the shaft, the tool is then withdrawn and re-applied, precisely as in turning the back surface, fig. 349; these alternate cuts being repeated, until the tool has penetrated sufficiently to cut a continuous circle; the chisel is then transferred to the

opposite extremity of the intended circular portion, to turn a corresponding surface; being steadily held and gently used throughout, to avoid splintering the corners of the square portions, thus left intact.

The separate and short squared pieces employed for the plinths in the various figures, or for the abacus of a column, are more conveniently produced from cylinders, having both faces surfaced and of the required height. For rough purposes the edge of the cylinder having been marked from end to end with four equidistant lines and these connected into squares by others marked on both surfaces, the four sides may be cut away with a saw and finished to the lines by filing. More accurate results with economy of time, are obtained by turning the flat edges, the work held by its surfaces in the upright chuck, fig. 319. The cylindrical piece divided and marked as above, is held with one of the surface lines parallel with the true surface of the chuck, adjusted laterally between its jaws until both sides of its circular edge on revolution describe the same circle; the ring being fixed, one side is turned down to the line marked, and tested with a straight edge, that it may be left neither concave nor convex. The operation is then repeated on a side contiguous to the first, which may be called two, and the angle formed by the two sides tried by the inner edges of a steel square; should it prove incorrect, as is probable, the ring is slackened and the work is slightly shifted relatively to the surface of the chuck, that two, may be turned and tested over again until it is found that the two sides form a right angle. The sides three and four are turned parallel with those previously completed, by the simple expedient of placing first one and then the other of the latter in contact with the parallel back of the chuck, or if the gap in the chuck be too deep, against a parallel slip of wood interposed between the two. The work being removed from the chuck from time to time during the reduction of the fourth face, to measure the width across from four to two, that it may agree with the width from one to three. The central aperture is turned subsequently to the square sides; its axial truth in both directions being determined by chucking the square piece, held by its corners, in an ordinary wood spring chuck in which the circular fillet and shoulder have been turned true. Hexagonal and other

pieces having a greater number of sides, may be turned after a similar method.

The softwood chisel, or the flat tool, fig. 331, either tool held in the horizontal manner, are the most efficient for turning the upright flat faces upon either hard or softwood. The faces are first reduced by separate cuts placed side by side, after which the tool may be traversed along them, the advance of the tool being cautiously given in either direction on account of the intermittent cutting and to avoid splintering the corners. Squares formed from plankwood cylinders splinter at the corners in turning the sides across the grain; this may be counteracted by leaving the cylinder too large in diameter, turning the first side across the grain, then two with the grain to obtain the right angle, and disregarding the splintering, proceeding to reduce three across the grain, parallel to one and to the width of the square. The side two is then replaced parallel with the surface of the chuck, and reduced until the splintering at the corners disappears, and the square is finished by turning four to the width and parallel with two.

The various cubes forming portions of the combined specimens of plain turning, may all be produced with sufficient accuracy in the manner just described, by turning the original cylinder to the correct height of the cube, and then reducing the other four faces until the thickness in either direction agrees with it. The cubes being then mounted in wood spring chucks, to turn the central apertures to receive the ornaments or other parts to which they are connected. The chuck, fig. 319 may be made to serve for several sizes of cubes, by interposing thin parallel filling pieces, of metal, wood or card, on either side between the jaws and the surfaces of the cylinders; while its convenience for work that has to be frequently shifted, is increased by replacing the ring by the metal screw clamp, fig. 756.

A cross with its shaft and either two or four arms springing from the faces of a cube, may be readily turned, and is also effective as a finial for other works. For the simpler form, in which the four centers of the arms lie in one plane, the material is prepared as a flat, parallel, oblong piece, the length-way of the grain, of the requisite thickness to give the two plain faces of the cube, and of suitable length and breadth.

Two center lines in appropriate positions are marked at right angles on its surface, the terminations of these lines are drawn with a square across the edges, the thickness of the latter being also bisected and marked around by other lines; thus giving the centers for the shaft and the two arms. The superfluous material being cut away with a saw, the shaft of the roughly-formed cross is mounted in the lathe by its centers, and the length lying between the chuck and the arms is turned cylindrical or to any other form; this position being usually selected, that the hands and rest, may more conveniently avoid the portions revolving at right angles. The work is then reversed end for end, and the opposite half of the shaft is turned and completed in like manner. The square shoulders turned upon the two halves towards the arms, from the upper and under faces of the cube, and the faces of both are reduced until while at equal distances from the center line of the arms first marked, the total width between them also exactly equals the thickness of the original parallel piece. The foregoing is then repeated, with the cross mounted by the centers marked at the ends of the arms; this completes the cube and finishes the work, but the turning requires rather more care as it is now across the grain.

A cross with four arms is produced from a cylinder, of sufficient diameter to contain the length of one pair and the width of the cube. Both ends of the cylinder are first reduced to the form and dimensions of the shaft, leaving a portion of the original diameter between them, as a collar with vertical faces, its width, the height of the intended cube. The edge of this collar is then bisected and marked with a line, and divided across into four equal parts for the centers for the arms. Angular pieces being cut away with the saw from between the portions required to remain, each pair of arms is mounted by its centers and turned as previously described; gradually and equally reducing the width between the vertical faces of the cube under operation, until that exactly equals the height, the original thickness of the collar.

SQUARE FORMS CONTAINED BY CONVEX FACES.

A variety in square work adapted for shafts and pedestals, is obtained by turning the separate faces of one, or several

similar pieces at the same time, as flat arcs of large circles. Shafts are turned attached to the edge of a large cylinder, larger flat pieces are sometimes turned on the cylinder, but with greater convenience when attached to the front of a wood surface chuck.

The piece for the shaft planed parallel and to a square section, is received within a corresponding groove on the surface of a plain drum or cylinder, fig. 749, parallel with its axis, so as to complete the periphery. The cylinder is then turned to the profile desired for the shaft, the exposed face of the latter,—1, in the upper diagram fig. 750,—thus at the same time receiving its figuration. The shaft is then withdrawn, turned one quarter round, and replaced in the groove with its turned face 1, towards the operator, when the second face, 2, now occupying the previous position of 1, is submitted to the action of the tools ; the positions and advance of the

Fig. 749.

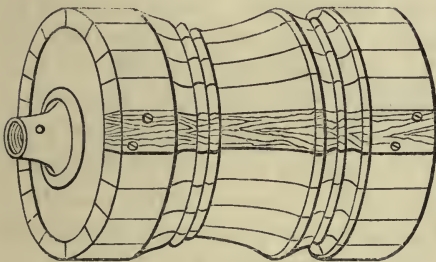
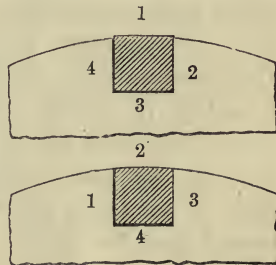

Fig. 750.



tools in turning the second and following faces, being guided by the curvature and mouldings just previously turned upon the cylinder. The third and fourth faces are turned in the same manner, but require some additional precautions. Bergeron referring to this method, describes the grooves to receive the shafts as cut in the solid cylinder ; this may be done but they are more readily formed by attaching straight slips of wood by screws, touching each other all around the drum, as in fig. 749. The shaft is conveniently fixed within its groove in the same manner, by joiner's screws passing transversely through its square ends into the drum ; which ends being beyond the finished length of the work are afterwards cut off.

The groove is essential to avoid intermittent cutting, and to support the vertical face at which the tool cuts free from the work. Thus when the second face is being turned, as in the lower diagram, fig. 750, it is apparent that the edge which meets the tool, being more or less reduced by the forms turned upon 1, is but slightly supported by the left vertical side of the groove. This is not of so great importance as the tool cuts from the edge on to the side of the shaft, and with gentle management does not splinter the corners; on the other hand the still plain side 3, at which the tool leaves the work as it passes on to the cylinder does not splinter, from being supported by its complete contact with the right vertical side of the groove. When turning the side 3, the corner it forms with 4, receives protection in like manner, but 1, being now beneath, the shaft is no longer in complete contact with the bottom of the groove, and is liable to spring under the tool; this is prevented by inserting two or three small pieces of wood as stops, between the bottom of the groove and those portions of the shaft that have become attenuated. These supports are the more necessary in turning the last side 4, but as this has also been narrowed in width by the reduction of both the faces 1 and 3, it obtains no support from the right side of the groove, and this has to be remedied by the insertion of a slip of wood, flat upon the one face against the side of the groove, and cut out upon the other to the contour of the mouldings turned upon the shaft. The shafts are either made of sufficient length, for their end surfaces to be flush with those of the cylinder, or if shorter, they abut against a stop fixed in the groove; when in either case as they are replaced; all the four sides are turned exactly opposite to each other, and their various forms and mouldings correctly mitre.

The wooden surface chuck employed for turning work of larger spread but of small elevation, such as the foot of the candlestick, fig. 751,—the shaft of which is represented as turned upon the drum,—is provided with a projecting, wood ring, the height of the piece to be turned, attached to its surface. The ring is cut through across, down to the flat surface on which it is carried, with one or several parallel openings to receive one or more pieces of the work, one of which only is shown shaded in the illustration; the ring may be made of one

solid piece, or for large diameters of several segments screwed down upon the surface of the chuck and then turned to the circle. The work is held by its flat under surface by screws placed through from behind the chuck, and is therefore always equally firm for turning all four sides, and cannot spring from the tool. The upright side of the notch in the ring supports three of the sides of the work as the tool leaves them, but, as with the shafts turned on the cylinder, the filling piece is required to prevent accident to the last corner. The margin of the ring acquires the mouldings given to the first side of the work, and then serves as the guide in turning the remaining three.

With the drum or surface chuck of sufficient diameter the larger faces of the work approach the straight line, while those

Fig. 751.

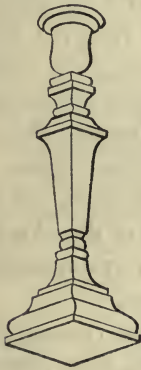
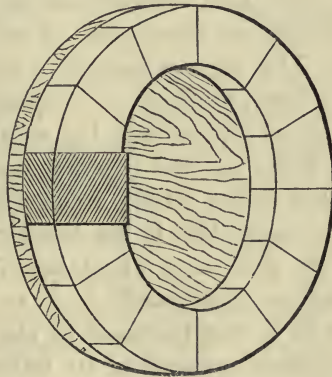

Fig. 752.



portions most reduced in size can often hardly be distinguished from it; the square work may also be varied by circular portions, subsequently turned upon it when between centers. It is however evident, that fig. 752, will often be too large in diameter for the five inch center lathe, even when the lifting blocks, figs. 182. 183, are used. In such cases the lathe head may be turned round to stand in the other direction, so that the chuck may revolve beyond the end of the lathe bearers, the hand rest being temporarily supported on some other structure, and the lathe kept in motion by a second person.

This old method of square turning is followed by Mr. J. Royffe, a furniture turner, who has received an award for his

productions, from the Worshipful Company of Turners, London; and from whose individual practice some of the foregoing particulars are derived. His works which bear critical examination, deserve the more commendation, the process having suggested itself to him solely from the ordinary plan adopted to avoid splintering the edges of the long mortises cut in the shafts of wooden bed posts, viz.—that of filling them with slips of wood level with the surface, previously to turning the work circular.

RADIAL FIGURATION OF CYLINDRICAL MARGINS.

Projecting ornament of the character of those upon the edge of the central piece, fig. 744, may be turned upon the work in the solid, or its cylindrical edge may be recessed to receive inlaying, when held between centers in a useful variety of the upright chuck the description of which was reserved for this chapter. This may be made of a hollow wood plain chuck, or for larger work, such as an ornamented ring surrounding the upper part of a pianoforte leg, as a box, formed of flat pieces of wood firmly screwed together around a square base. The two pointed center screws, frequently also of wood, are placed opposite to each other in the diametrical line of the chuck, and support the work as a wheel, figs. 753. 755, by corresponding hollow centers made axially in its two surfaces.

The work is first prepared to shape, turned concentric, but left everywhere in excess of its finished form, more especially upon its two ends, which each receive a deep conical hollow center. The cylindrical or curved edge, is then marked with a circular line for the vertical position, and divided across into equi-distant parts, for the number of the ornaments; every intersection being deeply indented with a center punch. Placed in the chuck, the work held rather stiffly between the pointed center screws, is shifted laterally by slackening the one and tightening the other, and shifted round between them, until one of the center marks is adjusted to the mandrel axis. It is then fixed in this position and sufficiently securely for turning, by one or two long joiner's screws, passing through one side of the chuck and indenting the end face of the work. The ornaments may be turned as plain hemispheres, hollows, grooves

or other forms, or these surrounded by mouldings, each member of every separate ornament concentric. One being turned, with the tools held and advanced as described in previous examples of turning upon the edge; the two binding screws are sufficiently withdrawn to permit the work to be moved round upon the center screws, so as to place the mark for the succeeding center in the axis of the lathe, and so on for the remainder. Every ornament may be completed seriatim, but, as the binding screws make a number of indentations in the end of the work corresponding to the number of ornaments turned upon its edge, every one may be readily returned to, to gradually produce the series, or to make alterations.

The work is marked with more than one circular line, divided accordingly with the division plate, when more than a single

Fig. 753.

Fig. 754.

Fig. 755.

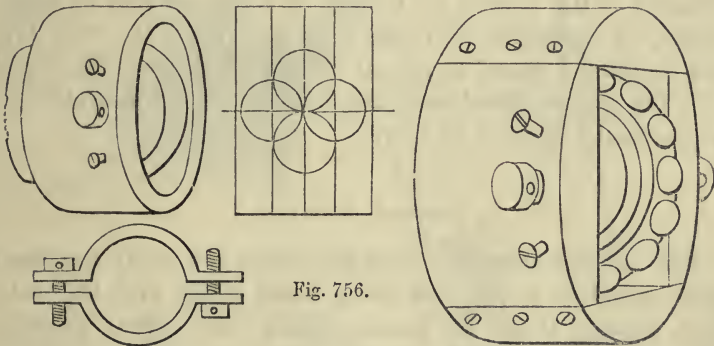

Fig. 756.

series have to be turned upon it, as for placing corresponding ornaments at both margins of the edge. The diagram, fig. 754, shows the edge marked with lines for three series of centers, which are arranged for the circles to cut into one another to produce incised eccentric ornaments, somewhat the character of figs. 740. 742. In such cases one series of circles being turned, the work is shifted laterally by the center screws, and another placed opposite the mandrel axis; the external and internal diameters of the forms of all the raised or incised work, being in every case turned to fit the profile of a thin template, to ensure their similarity. For the analogous orna-

mentation of conical edges, as that in fig. 745, the two center screws pass through apertures in the sides of the chuck, placed in the diametrical line, but pierced at the appropriate angle. The radial turning completed, the work is in all cases mounted between the lathe centers to finish the forms of the end surfaces, and to turn any portions of the edge that may require circular reduction.

Discs and rings turned from the wood mosaics, known as Tunbridge ware, form an effective variety, when inlaid in the edges of cylindrical work, in apertures turned in the manner just described; as also for surface ornamentation, inlaid after the modes mentioned pages 539—543. These mosaics may be obtained; but the long strips of wood, of triangular, square and rhombic sections composing them, may be very easily cut out with the circular saw and combined into suitable patterns, by following the simple expedients given at length, Chapter XXVII. in the second volume. More effective results may be obtained if the mosaic be formed of a less number of larger pieces, as explained in relation to figs. 744—746 Vol. II.; this avoids the excess of minute detail, which generally aimed at in the manufactured specimens, is not always desirable for the particular purpose in view.

PROFILE TURNING.

The simpler examples of these works are easily produced upon cylinders, knobs, and other small solids, with the ordinary turning tools, by turning them into curves grouped together to represent the features; they show the same profile upon both sides of the axis, but nevertheless have some effect when the features copied admit of sufficient accentuation. Turned as rings, the outer and inner edges and the surfaces may receive different profiles forming a complete outline, displayed when the ring is cut up into sections. A method largely followed in shaping the forms of animals and other wood toys, many of which are turned in softwood as large rings, and then sliced up with the paring knife, fig. 8 Vol. I., into small segments to be finished by hand.

With increased care the ring may be turned with the separate hand turning tools, to exactly represent any given section,

such as that of the human head ; the application of the tools being facilitated, by turning the surfaces to fit templates cut out to parts of the outline. Profile turning is still more exact if the cutting edges of the tools are shaped to the form desired ; and the work having first been prepared nearly to the form with separate tools, as in using all large moulding tools, the profile tools at once reduce the outline to its exact proportions. These tools may be met with, but as the most acceptable, the author has constructed a series of four tools after Mr. Wyon's beautiful head of her Majesty Queen Victoria.

The wood or ivory ring under formation, fig. 757, shown cut in halves and of its original rectangular section to exhibit the

Fig. 757.

Fig. 758.

Fig. 759.

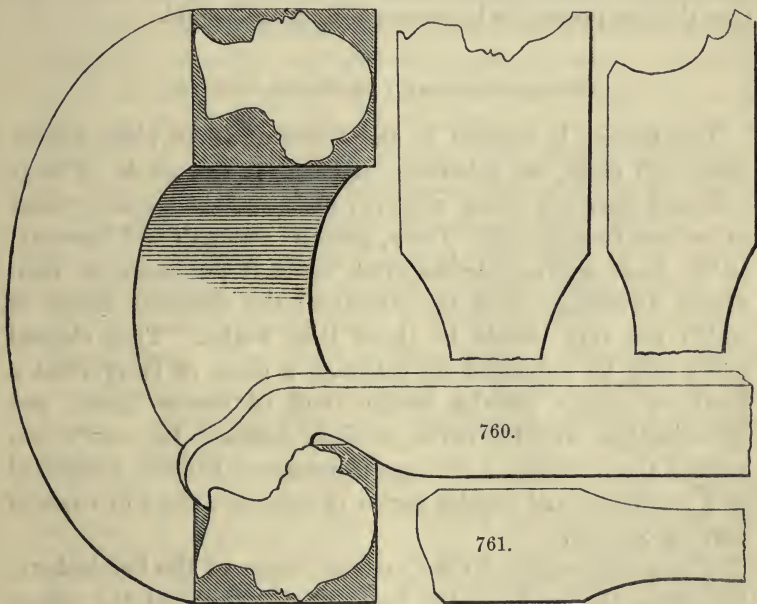

application of the tools, is first turned true as to height and thickness ; and is then reduced nearly to the form upon its outer cylindrical edge, with separate small tools. The profile tool, fig. 758, serving first as a gage for their direction, after which it is itself used to cut all along the contour. The end surface and the inner cylindrical edge, are then treated in a

similar manner, the edge of the tool, fig. 760, being shown in position travelling outwards diagonally to the original square section of the ring, to undercut the back of the head. The ring is reversed upon the chuck to turn the fourth side with fig. 761. All four profile tools are then returned to and more carefully employed to finish the outline, and to reduce the height or width of the section, should that be desirable. For turning the external surfaces, the ring is held from within upon a solid wood plain chuck, with one of its faces in contact with the shoulder, and for the internal portions, in a wood spring chuck, its upper or under surface in like manner in contact with the true face turned within the chuck. The finished profile ring is cut radially into thin slabs, subsequently made parallel, to be fixed down upon the surface of other works; or into thicker pieces, to be mounted upon pedestals.

TRANSPARENT AND SLENDER TURNING.

The former is applied in the bowls of small plain turned vases and tazze, the substance of parts or the whole of their hollowed portions being reduced, until sufficiently attenuated to become transparent. Ivory, from its strength and tenacity, is the most appropriate material, while it possesses an incidental advantage from its structure, the different layers of which are very visible in these thin works. This elegant effect may be enhanced by selecting a piece of ivory from a tooth of nearly circular section and of coarse grain, and chucking this with the nerve precisely central; the entire thin surface then exhibits a delicate transparent pattern, composed of a numerous and regular series of eccentric rings or ovals of varying opacity.

The sections given to the vase are those of the hemisphere, the tulip, the oval divided upon its shorter, and the ellipse upon either diameter, all forms having their greatest internal width at the mouth. The piece is first turned nearly to its external and internal shape, the curvature of the latter is then completed and polished, after which the work is mounted on a solid wood arbor chuck, *precisely* fitting the internal form. The wood chuck having been reduced nearly to this, the entire surface of the hollow of the vase is moistened with some

coloured mixture, such as powdered red chalk and oil, and the work is applied to the chuck to obtain its exact counterpart. It marks all parts of the chuck that require further reduction by the tool, and the work is continually re-applied in the same manner, until by alteration of the former, the two surfaces prove to be identical in curvature.

The whole surface of the chuck is then coated with lamp-black mixed in water, to which size or a small quantity of melted glue has been added; and when this is dry, the chuck and work having been slightly warmed, the two are carefully cemented together with thin glue all over their respective surfaces. After an interval to allow the glue to thoroughly harden, the external central portion by which the bowl is attached to its stem, is turned to shape, partially pierced with a plain hole or cut with a screw and polished; subsequently to which, the thickness of the bowl is gradually reduced externally, with the ordinary hand turning tools. As it becomes sufficiently thin the blackened surface of the chuck shows through the ivory, the equality of the colour shown affording the guide for the further and parallel reduction of the work, which by careful management of the tools may be continued to great tenuity. The upper edge may be left of the same thinness as the rest of the bowl, or it may be strengthened by a small bead or moulding turned upon it, as with the piece below, prior to reducing the remainder to transparency. The finished form is then polished, and the work is separated from the chuck by immersing the two in a vessel of water, until the one can be removed from the other without difficulty.

Similar specimens may be constructed in wood, but the material presents difficulties without usually allowing such complete results. The chuck and the work having been carefully prepared, the former is covered with white chalk rubbed on dry, a small portion within the lip of the vase only being glued, this glued portion being cut off and left on the chuck to release the finished work. Although not so readily executed in wood, excellent specimens may be met with. One, a masterpiece of antique German turning, in the author's possession, is a truncated taper vase made in beechwood, the transparent cup measuring two inches in diameter by the same

high, mounted in the *solid*, on a turned beechwood stem, ornamented by mouldings, the milling tool and incised work. The bowl contains fifty similar cups loose one within the other, the smallest the size of a thimble. All these are left from the tool, semi-transparent, parallel in thickness, perfectly smooth within and without and very pliable, being only the substance of a thin wood shaving.

Additional elegance may be given to the foregoing works by mounting the transparent bowls upon delicate parallel shafts, some three to six inches high, terminating above and below in small spreading mouldings to break their junction with the vase and the foot. In ivory, such stems may be readily reduced to one sixteenth of an inch or less in diameter, and they are mentioned, as being among the more delicate specimens of slender turning, a term comprehending all long works of relatively small diameter; the management of larger examples has been incidentally referred to in preceding chapters.

The piece for the shaft is securely mounted in a small, plain metal chuck, and supported by the point of the popit head. The terminal forms and mouldings are sometimes both first completed and polished at either end, while the piece is still strong; that most distant from the chuck, and its pin or screw for attachment to the bowl, being in all cases finished prior to any reduction of the slender stem. The whole length of the parallel portion is then a little reduced in diameter and turned true, after which a short length of about an inch, more or less, according to the size and length of the shaft, is further reduced with a small gouge or round tool, and finished to the required size with a narrow flat tool, the last held slightly tilted, as described page 303, so as to place both its corners free of the work. The reduction to size is commenced against the moulding and gradually completed towards the chuck, to careful measurement with the callipers or some other gage; after which, this short portion of the parallel stem is polished.

A second and shorter length is then reduced to size in the same way, commencing at the termination of the first and proceeding towards the chuck, but with the left forefinger placed

around the work from below, so that the first joint or the tip of the finger may restrain the work in true revolution and support it against the thrust of the tool; and this is continually repeated upon shorter and shorter lengths, until the entire shaft is completed. Every length being carefully measured for diameter, more especially where it joins the preceding, and polished, before commencing the next. With increasing length a very slender stem runs risk of fracture from its gyrations; the popit head has then to be withdrawn, but the work may be restrained by being passed through holes, sufficiently large to allow complete freedom of rotation, pierced in one or more thin pieces of wood attached at intervals to the lathe bearers after the manner of the boring collar. The moulding and the pin or screw beyond it at the chuck end of the shaft, to attach the stem to the foot, is usually turned last, with the work still in the same chucking, or with the piece reversed, and carried in a long wood spring chuck.

Other equally slender stems are turned with a variety of small ornamental shapes, left at intervals, which appear as if

Fig. 762.

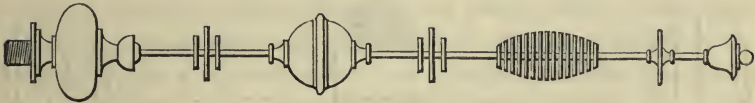

threaded upon them; that about the center of the length being generally larger, while the base of the shaft springs from some appropriate ornamental foot. These works, often eighteen inches or more in height, are constructed in pieces of moderate length, attached to each other at the larger ornaments. A short length is indicated by fig. 762; this would be readily turned as one piece, solidly chucked in one of the screw or die chucks or driven into a plain chuck.

The work as before is commenced at the opposite extremity to that in the chuck, and is turned in short lengths, every one of which is completed and polished before proceeding to the next. The piece if long is soon unable to sustain its own weight in the horizontal position, while its gyrations early require restraint; the wooden frame and cross threads, fig. 138, best meet both requirements, and two or more of these

supports may be employed. The screw by which the lower end of every length is connected to the next, is cut by hand, or with the traversing mandrel, from the shoulder towards the chuck, subsequently to the completion of the piece, which is then severed from that remaining in the chuck, leaving the work suspended in the threads.

When the sphere shown in fig. 762, is of a larger size, in place of turning it in the solid with the stem, it would be chosen as an appropriate piece to attach two lengths of the latter. A solid turned cube or other rectangular figure, or a sphere containing some other turned solid, is frequently employed for the main central ornament of the stem; the general effect being increased by the contrast between their magnitude and the delicate slender stem by which they are supported.

To leave a column in the solid, not to interfere with its strength as a support and at the same time for economy of

Fig. 763.

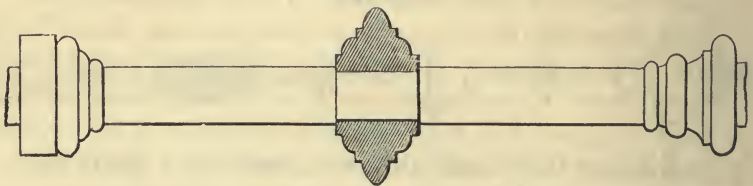

material, the furniture turner sometimes adds the piece to give additional diameter for a central or other ornament, in a manner different from any previously described. These works, although the antitheses of the delicate productions last mentioned, may be conveniently referred to here.

The column, fig. 763, is first turned to its general proportions, after which the width of the part that has to receive the piece to give increase of diameter, is reduced below the level of its neighbouring portions, turned to a true cylinder, and the narrow surfaces thus formed above and below it, turned square to its axis. The piece to be added, shown shaded, usually required of the same material, is selected of straight grain and rather too large in diameter; it is first

pierced with a cylindrical aperture carefully measured with the callipers to fit the cylindrical portion turned upon the shaft, after which its two surfaces are turned flat and true, until its height exactly agrees with the width reduced upon the shaft.

The annular piece thus prepared is then *split* with the grain into two halves, the two halves of the hole and those of the fracture, the cylinder and its two containing surfaces, are then all lightly coated with thin glue and quickly placed together; a screw clamp being immediately fixed upon them to force the two halves of the ring into contact with each other and the cylinder. When the glue has become hard, the shaft is again mounted in the lathe to turn the added piece to shape; this removes the marks left by the chisel or other tool used to split the ring, when, should a suitable piece of material have been selected and the work skilfully performed, the line of fracture is not easily detected and the completed shaft appears to be one solid.

TURNED TOBACCO PIPES.

These are made from many of the softwoods, their roots and burrs, pear and cherry tree are the more usual; from some harder kinds, and from the so-called "briar root," the last name being a corruption of the French *Bruyère*, the *Erica*

Fig. 764.

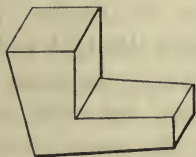

Fig. 765.

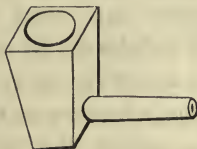

Fig. 766.

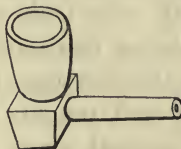

Fig. 767.



Arborea, a native of Southern Europe; from cocoa and other hardwoods, and from meerschaum. The bowl and stem are turned in one solid, the method followed is alike for all, the tools employed being those ordinarily used for soft and hardwood according to the material. This is first roughed out with the saw from parallel pieces, to the form of fig. 764, and if made from softwoods, the blanks require to be laid aside and allowed time to season.

The stem and bowl are turned at two chuckings, the short rectangular portion left at their junction, figs. 766, 767, being subsequently reduced to form by paring and filing. The interior of the bowl is turned first, with the blank held across the gap of the wood spring chuck, fig. 768; this is similar in character to the upright chuck, fig. 318, but to meet more constant use it is stronger and the jaws are closed by an iron screw bolt and nut turned by a key. The blank is then replaced in the chuck at right angles, the shaft adjusted to the center, that the corners of the stem may be removed with the gouge, leaving it strong for the boring, and the extremity is turned true, faced and centered. The delicate, long spoon bit for softwood, and the slender pipe bit used for boring the stems in hardwood, and their manipulation, have been described in the

Fig. 768.

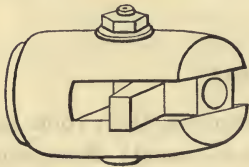
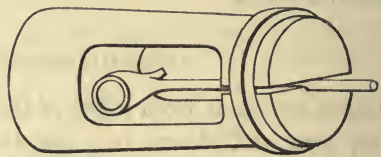

Fig. 769.



elementary chapters; meerschaum stems may be freely bored with either tool, or with the wire drill flattened and ground to a point, which last is used in boring amber. All the drills are advanced with care their shafts supported by the fingers of both hands, being frequently withdrawn to clear the tool and the hole from the shavings, to avoid risk of splitting the stem.

The bored and roughly shaped stem is then cut with an internal or external screw to attach the mouth piece, after which it is finished externally, the turning being carried as far as possible towards the bowl, fig. 765; the stem supported against the thrust of the tool by the left forefinger placed around it from below. The spring chuck, fig. 769, is employed for turning the more delicate stems, for alterations when the bowl has been finished, and for meerschaum. The interior is largely cut away to render the sides very elastic and to allow space for the bowl; they are closed on the work by a ring pressed on by hand, the ring sometimes receiving light blows

from the end of the tool handle, on the one or the other side of the face, to adjust the work to run true. Slender stems are projected and turned a short portion at a time, that close to the bowl held by the chuck, being finally reduced to shape with the file. Oval and flattened stems, are turned to the larger diameter of their section, and then worked down to form with the file.

The partially completed pipe is then mounted by the aperture in the bowl, upon the solid wood arbor chuck, fig. 770, to turn the exterior; the form is shaped as far as convenient towards the stem, the tool being advanced at a horizontal angle to prevent its shaft or the hands, encountering the stem as that

Fig. 770.

Fig. 771.

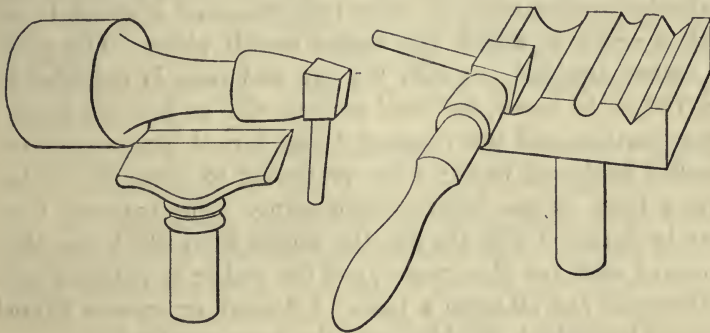

revolves. When the stem is at less than a right angle, fig. 767, a longer arbor chuck is employed, that the rest and hands may be well to the left to project the tool at a sufficient angle. The rectangular portion left at the junction by the turning, is pared or rasped away, and then filed down to shape, glass papered and polished, upon the wooden filing block, fig. 771. This is variously grooved upon the surface, and may be held in the vice, but is more frequently turned to a stem below, to fit the socket of the hand rest. The pipe held on a wooden arbor inserted in the bowl as a handle, is twisted round on the filing block when filing the bowl, and the bowl itself is held in the hand when working on the stem, the turned portions serving as a guide for the curved lines filed to connect the two.

The blanks for meerschaum pipes are sawn from the irregu-

larly formed masses in which the material is imported, and when soaked in water for about twenty-four hours, are turned and shaped after the same method as that described for wood ; most of the chucks and arbors being covered with cloth, or one or two thicknesses of flannel, to prevent damage to the soft material. The ordinary soft wood chisel is used wherever possible to turn the bowl and stem, but small round, flat and point tools, ground to a single, and equally acute bevil, are also employed. The tools are used as in turning the softest woods, and the meerschaum cuts or pares away with extreme readiness, but being also homogeneous, it is of easy management under the turning or carving tools.

The end of the meerschaum stem is bored for about an inch in depth, sufficiently larger than the bore of the pipe to admit a slender wooden tube, the short projecting end of which is cut with a screw to attach the amber mouth piece. The piece of amber, roughed out with the saw and rasp, is mounted in fig. 769, to be bored, hollowed and cut with an internal screw ; these portions and the exterior, being turned with any of the smaller hardwood tools ; some preferring to warm the amber over a lamp or gas, before commencing. The external form may be flattened with the file, the marks from which are then removed with fine glass paper, and the amber is polished with rottenstone and oil upon a piece of flannel, or upon a flannel covered buff wheel, finishing with the same powder dry.

Meerschaum pipes turned and filed to shape, have all file marks removed with nearly worn out glass paper or dutch rush, and are then further polished upon flannel covered buff wheels running in the lathe, charged with a fine white powder imported from Vienna, and known as "Calsch." The composition of this powder is a trade secret, but it appears to be a natural product principally composed of carbonate of lime, as indeed its name almost implies ; it is received in the form of small pieces, a few of these are taken, slightly sprinkled with water and allowed to remain for a day or two, when they crumble into a fine and perfectly even powder, fit for use.

The round edge and the flat face of the buff are both employed, the latter for the turned portions of the bowl and stem, which are held radially and twisted round upon it by the fingers. The buff however is very sparingly used, otherwise it

is too active for the soft material ; the polishing is then continued by friction with the powder applied on a piece of flannel. Subsequently the pipes are rubbed with flannel and melted white wax ; in which latter, their apertures being temporarily stopped, they are sometimes immersed.

SECTION II.—STAINING, DYEING AND DARKENING.

In turning it is frequently necessary to use a piece of wood of a different kind to that from which the work is principally constructed, in order to attain a sufficient diameter for some one portion. This may add an agreeable variety, but it may be desirable that the entire work should appear to be made of the same material, when the one has to be stained to agree with the other ; while large works, which generally can only be made of sufficient size when turned entirely from the soft woods, are frequently stained or dyed in imitation of the hardwoods.

Among the softwoods thus employed the following are the more readily obtained, viz., pine, chesnut, maple, sycamore, pear, ash, satinwood, beech, oak and mahogany ; all of which, as also boxwood and the lighter coloured hardwoods, may be readily stained or dyed to a variety of colours. The colours required by the turner however, are limited to those which will stain the whiter woods, or heighten the tone of the darker, to various shades of yellow, brown, red, purple and black, to imitate the natural colour of other woods employed, or to obtain resemblance when the colour of two pieces of the same species of wood are found to considerably differ. In all cases the various portions to be stained have their surfaces turned and finished as smoothly as possible, and should be quite free from oil or accidental soiling of any kind, a condition essential to successful and equal results.

The stains employed are obtained principally from the dye woods and are preferred from their transparent nature, an important feature, as they do not hide the grain of the wood to be coloured ; the mixture of pigments being objectionable in this respect, these are avoided, unless it be required to japan the work, after the manner described in the third volume. The colouring matters are extracted by water, spirits

of wine or oil. The decoctions may be used, first, as simple stains. Sometimes one only is so used, at others, when the applications of this one are deemed sufficient, a different stain is applied over it, to brighten or vary its colour. The work may have the water stains plentifully and several times applied with a flat camel's hair brush, being allowed to dry between every wash, or it may be immersed and remain in the fluid one or two days, according to the material, and the strength of the stain; the brush being used for the lightest, and immersion, for producing the deepest shade of any colour. Some of the colours thus given are more or less fugitive, fading under exposure to air or light, but they become fairly permanent, if the work be polished with lacker or varnished, so soon as the stain is thoroughly dry. The softer woods are stained to a little deeper colour than permanently required, to allow for a subsequent loss of tone by absorption. The same decoctions are used secondly, as dyes, when, after the work has been sufficiently imbued with the one selected and allowed to dry, a second fluid, usually acid or alkaline, is applied as a mordant to change and fix the colour; the work being then dried and polished or varnished, as before.

The tinctures, which are readily made and preserved, are convenient for small quantities for moderate sized works, and are applied with the brush. They are usually deeper in colour than the corresponding water stains, and are employed in precisely the same manner either to stain or dye, and when used for the former purpose are about as fugitive until the work is polished.

Alkanet root, and Dragon's blood, an East Indian resin, which are used to improve the colour of pale mahogany and other red woods, to agree with that of better specimens, are steeped in linseed oil, to which each gives a brilliant crimson colour, that from the first having a purple tinge. The colouring matter of the Alkanet root is contained in the rind, so that the smaller pieces are preferred; Dragon's blood, which is only partially soluble in alcohol, almost dissolves in oil. The practice followed is to place a small quantity of either in some shallow open vessel, and then to add sufficient oil to rather more than cover it; the oil rapidly acquires the colour and is fit for use in a few days, and a fresh supply of oil may be added

when the first has been used. The work may be coated with the coloured oil and allowed to stand a day or more until it is fairly absorbed, after which it is cleansed with dry clean rag before being polished. Very generally however in improving the colour of one piece of wood to agree with that of another, the coloured oil, only takes the place of the linseed oil used with the lacker or French polish, in which manner the required tinge may be readily arrived at. In following this mode many prefer to saturate the rubber with the coloured oil and then to place some of the lacker upon it, thus reversing the usual order in the preparation of the rubber.

A bright *yellow* stain is obtained from two ounces of Turmeric, allowed to simmer for some hours in one quart of water in an earthen vessel, water being added from time to time to replace that evaporated; the method which is followed in the preparation of all the water stains mentioned. This, sparingly applied cold with the brush, stains the white woods to the colour of satin wood; by immersion, they obtain a bright canary yellow, largely used for toys, which may be rendered permanent without polishing by the application of a strong solution of common salt. Washing the stained work over with nitro-muriate of tin for about a minute, changes the colour to *orange*, of a depth of tone corresponding to that of the original yellow; the work should then be immediately well rinsed in plain water to check the further action of the acid fluid. Treating the wood stained with turmeric, after it has been allowed to dry, with a mordant of two ounces of sulphate of iron dissolved in three quarts of water, dyes a delicate *olive brown*, suitable for light cocoa wood. A tincture made in the proportion of a quarter of an ounce of turmeric to three ounces of spirits of wine, allowed to stand for some days and well shaken daily, gives similar results of a rather higher colour, which when dry, may be also treated with the fluids mentioned.

The tones of the stained woods may be rather largely modified, by the colour of the polish used upon them. The lightest colours therefore, are polished with the lightest coloured lackers, or varnished with a white varnish, the ordinary hardwood lacker being used upon the darker. All the softwoods being also very absorbent, they usually receive

a coat of size, mixed in the proportion of one part of ordinary size to from two to three parts of water; this is applied tepid and allowed to thoroughly dry, prior to their being polished or varnished, to fill the pores of the surface, both to economize time and lacker, and to render the polish more permanent. The fluids in many cases will also raise the grain of the wood, so as to slightly roughen the smooth turned surfaces. No attention is paid to this until the work has received a moderate coating of the polish or varnish employed; the surfaces are then gently rubbed down with fine glass paper, carefully avoiding the extreme edges turned on the work, from which the colour may be more readily removed, after which it is re-polished.

A very serviceable *deep red* stain of a crimson character, employed either to imitate mahogany, or to tinge and vary the colour of the actual wood, is obtained from half an ounce of the raspings of Brazil wood macerated in three ounces of alcohol. The colour this gives to mahogany may be varied by also coating the work with the logwood stain mentioned below; a wash of this last given with the brush, and when dry followed by a wash of brazil, produces a deep full colour, and when the two are applied in the reverse order, a similar but more brilliant colour. A decoction of four ounces of brazil wood, allowed to simmer for some hours in one quart of water, yields a rather *brown red* stain. White woods stained with this, and when dry treated with a solution of half to one ounce of pearlash in one quart of water, vary in colour, according to the original depth of tone given to them by the brazil stain, from browns suitable for cocoawood, to deeper purplish browns, adapted for kingwood. The iron solution already mentioned, produces a rich *purple brown*, an excellent imitation of full coloured rosewood or peruvian wood. White wood stained with the brazil, and then subjected to the action of alum, four ounces dissolved in one quart of water, acquires a light *pink*, which, helped by the grain of the wood answers fairly for tulip wood. Treating the lighter coloured woods stained by brazil with nitro-muriate of tin, gives a very beautiful, brilliant *crimson* of a purple tinge; this is of no great service in imitating other woods but is largely used upon toys.

A *brown red* stain is made from a decoction of two ounces

of logwood dust in one quart of water, or from half an ounce of the logwood in three ounces of alcohol. This is employed to darken mahogany and other coloured woods, used either alone or with separate applications of the brazil as above. Nitro-muriate of tin applied on the logwood stain, gives a deep dusky crimson *purple*, very suitable for full coloured kingwood and for imitating many other hardwoods, darkened by long exposure. The logwood, subsequently treated with the alum solution, yields a medium purple, both darker and of a bluer tone than that obtained from brazil wood. Treated with the pearlash, it affords a brown, darker than that obtained by this alkali from the brazil wood, and in like manner used for cocoa wood.

A *jet black* may be given to all the woods, by using the logwood stain, followed by a solution of iron, in the proportion of an ounce of sulphate of iron to one quart of water; and a less intense black, by the same mixtures about three times diluted. Further dilution will afford various degrees from black to gray; the light *silver gray* given to the white woods turned at Spa, may be produced by immersing the work in a decoction of four ounces of Sumach in one quart of water, and afterwards in a very dilute solution of sulphate of iron; the works so stained are then sized and varnished with hard white, or with sandarac varnish.

A dilute solution of bi-chromate of potash is frequently employed to darken oak, mahogany and the coloured woods, to which it imparts a brown shade, useful to give the appearance of age; this stain requires using with some care, as its effects are continuous, and are not altogether stayed by thoroughly washing the work with water when the required depth of tone has been reached. It may also occasionally be necessary to follow the opposite course, that is to reduce the depth of the natural colour of the material: most of the woods may be more or less bleached by immersion in a strong solution of oxalic acid applied with heat.

Ivory when turned to its finished form, has its surfaces dyed by immersion in many of the before mentioned water stains, and in some others. The process presents no difficulties, but

being both rapid and cumulative, it requires close attention that it may be arrested the moment the required tone is attained; only two or three pieces of ivory can therefore usually be dyed to precisely the same colour at one operation. The pieces are always first polished with whiting and water, and when washed quite clean from the whiting, are then prepared for the stain by a short immersion of from three to five minutes in acidulated cold water, in the proportion of one part of muriatic acid, the ordinary acid of commerce, to forty or fifty of water; or, in an equally weak solution of nitric acid. This cleansing fluid extracts the gelatine from the surface of the ivory, and is essential to the attainment of a perfectly uniform colour; extreme cleanliness, and the absence of any grease or accidental soiling are as necessary, with which view the work in process of staining is at no time touched by the fingers, but is removed from one vessel to another by flat pieces of wood, attached to each other at one end by a curved metal spring, after the form of a pair of sugar tongs, separate pairs being kept for the different colours. Subsequently to its treatment with the acid, the ivory is invariably again placed for some minutes in clean cold water, that has been boiled, before it is transferred to the stain.

Those water stains used that have been already mentioned, and all others, are prepared in the same manner as for wood, but they are afterwards strained or filtered. They are employed warm or only tepid, too great heat in the stain, as also too large a proportion of acid in the cleansing fluid, very injuriously affecting the surface of the ivory. Increasing the temperature in many cases also considerably deepens, and in others, entirely changes the colours sought; the most certain results arise when the stains are used at about 100° Fahr., they then act with sufficient rapidity, and the ivory may be removed from time to time for examination and replaced until the required tint is obtained. Average times of immersion are mentioned for the above temperature, but some pieces of ivory are found to acquire the colour more rapidly than others; when sufficiently stained the ivory is again well rinsed in water, and when one stain has to be followed by another, the ivory is also always first well rinsed before it is transferred to the second bath of colour. Having been finally allowed to thoroughly dry,

the work is re-polished by friction, first with a few drops of oil on soft clean rag to give it a lustre, the friction being then continued with dry clean rag, until the oil disappears.

A pale *yellow* results from an immersion of about one minute in the tepid stain given by 60 grains of saffron, boiled for some hours in half a pint of water. Five to fifteen minutes produces bright and deep canary yellows, but all these colours are rather fugitive. A stain made from four ounces of fustic dust and chips boiled in one quart of water, produces very similar, but darker and far more permanent results. Ivory subjected to either of the above stains for about fifteen minutes, washed, and then placed for from one to three minutes in the brazil water stain, previously mentioned, acquires an *orange*; and the same, then treated with nitro-muriate of tin, yields a clearer orange of a brighter, redder tone. The action of the nitro-muriate of tin upon the stained ivory is always exceedingly rapid: the fluid may be plentifully applied to the work with the brush, but immersion is safer, as producing more equal effects. The work in either case, being immediately transferred to a clean water bath to check further change, so soon as the required colour appears.

Fine scarlet cloth is employed for dyeing various tones of red, the finely divided dye extracted from the cloth, being found to yield more uniform colours than stains prepared from the crude cochineal. With a stain prepared from a piece of cloth about a foot square cut into shreds, and boiled with the addition of about ten grains of pearlash in half a pint of water for five or six hours; immersion for from three to ten minutes, gives a clear, delicate *pink* of different depths of colour. Ivory placed in this stain for one hour, and subsequently for half an hour in the alum mordant mentioned for wood, obtains a pink of a bright crimson character. Pink colours of a different and dull full tone, may be obtained by immersion for three minutes in the brazil water stain, followed by treatment with nitro-muriate of tin; and when the brazil is used for six minutes, a still deeper colour results.

A *crimson red* follows when the ivory is allowed to remain for from two to three hours in the tepid red cloth stain. The addition of a small quantity of sulphuric acid, in the proportion of about one part of acid to sixty of the stain, gives a very

brilliant crimson of a rather scarlet tinge, employed for billiard balls. The plain red cloth stain applied for about an hour, and the ivory then treated for about half an hour in the pearl-ash solution, affords bright *purple* colours, and when the iron solution replaces the pearl-ash, more sombre purples. The addition of further quantities of alkali to the cloth stain, in place of the acid, yields *purple reds* of varying depth of colour.

Ivory immersed for fifteen minutes in the decoction of brazil, and then treated with the nitro-muriate of tin and immediately washed, acquires a duller and rather deeper red than that given by the first red cloth stain; and the depth of colour may be considerably increased by a longer immersion, or by a higher temperature in the brazil bath. A dull scarlet or *brick red* is obtained when the brazil bath is followed by immersion for from thirty to sixty minutes, in the alum mordant for wood. Fifteen minutes in the brazil, and then three to four minutes in the solution of pearl-ash previously mentioned, gives full *red purples* deepening to *maroon*.

Ivory immersed for five minutes in the logwood water stain given for wood, obtains a good warm *brown*, and continued in the stain for about half an hour, a deep *chocolate* brown; tones between, again arising from varying the length of exposure. Immersion in the logwood for ten minutes, washing, and then dipping for one or two seconds in the pearl-ash solution and again instantly washing, gives a deep *red brown*, and a similar treatment for one minute in that of alum, a deep *purple brown*.

Blue stains may be obtained from the ordinary, fluid sulphate of indigo of commerce, in the proportion of half a drachm to one pint of previously boiled water, with the addition of about 10 grains of carbonate of potash. One to two minutes immersion, and immediately washing, yields a delicate turquoise, five minutes, a bright full blue, and ten to fifteen minutes, a considerable depth of colour. The blues are rather fugitive, so that in practice the ivory has to be stained to a deeper shade than permanently required. Nitro-muriate of tin entirely destroys the colour.

Staining with saffron or fustic for five minutes, and then for the same period in the indigo, as above, produces a clear *pea green*, and when the latter stain is continued for ten minutes,

a deep *grass green*; the greens from fustic being more permanent and of a yellower shade. The sequence in which the two stains are employed also considerably influences the tone of colour, the character of which is determined by the second; being bluer when the indigo is used after either yellow stain, and yellower, when the saffron or fustic follow the indigo. Nitro-muriate of tin brightens the colours of those greens in which the fustic is employed last, but it requires to be used rapidly and with caution, to prevent its attacking the indigo. Immersion in the blue stain first, and for fifteen minutes, followed by the fustic for thirty, stains the ivory a deep bright green of the colour formerly largely employed for table knife handles; a colour which may otherwise be obtained, by a very protracted immersion of the ivory, extending over some weeks, in a clear solution of verdigris in dilute vinegar and water.

Jet black is obtained by immersing the ivory in the logwood stain for fifteen minutes, well washing, and then placing it for five minutes, in the solution of one ounce of sulphate of iron in one quart of water, employed for staining wood.

END OF THE FOURTH VOLUME.

The first part of the history of the
 world is the history of the
 creation of the world and the
 life of the first man, Adam.
 The second part is the history of
 the world from the time of
 the fall of Adam to the
 birth of Jesus Christ.
 The third part is the history of
 the world from the birth of
 Jesus Christ to the present
 time.

THE HISTORY OF THE

world from the birth of
 Jesus Christ to the present
 time.

INDEX.

A.

- ADHESION, injury to mandrels from, 96.
 Adjusting Index, 119, 122; use of, 120.
 — — prime numbers obtained with, 125.
 Adjustment of boring collars, 129.
 — — slide rest tool to height of center, 145.
 — — slide rest to surface and cylinder, 149.
 Amber, turning, 570.
 Ames', Mr., Chord dividers, 387.
 Ancient authors on turning, 2, 5, 18, 20, 22, 30, 35, 60.
 Annealing steel forgings, 334.
 Annular additions to columns and shafts, 566.
 Apparatus, for spiral turning, 157.
 Arabian lathe, 8; driven by the bow, 9.
 — Meshrebeeyeh work, 10.
 Arbor, 363.
 — Brunel's expanding, 226.
 — Chucks, 221; for circular cutters, 206; screw, 238.
 — Spiral, 161.
 Arch, Gothic, 537.
 — in turning, 506, 537.
 Archery bow lathe, 21.
 Arm, radial, 115, 160.
 Armrest, 308.
 Astragal bead tools, for hardwood and ivory, 298.
 Atkinson's, Mr., Reciprocator, 175; manipulation of, 177; on the surface, 179; wheels used with, 176.
 — — Barrow's index for, 177.

B.

- BACKBOARD, 101.
 Back center, lathe heads, 64, 93.
 — — mandrels, 95; improvements in, 73.
 — — mandrels and collars, 74.
 Backgeared faceplate, 81.
 — mandrel, 79, 110.
 Backgearing derivation of, 79.
 — internal, 113.

- Backlash between the carrier and work, 198, 389.
 — in screw cutting, 387.
 Backrest, 20.
 Backstay for boring, to mandrel, 78.
 — for metal turning, 135.
 — for ornamental turning, 136.
 Balance of proportion of outline, 448.
 Balustrade turners, lathe used by, 153.
 Bands, catgut, 51; hooks and eyes for, 54; splicing, 52.
 — crossed, 44, 86.
 — tension pulleys for, 56.
 Bands and pulleys employed for screw cutting, 152.
 — — — — to traverse the slide rest, 155.
 Bar Lathes, 66.
 — — comparison with lathe bearers, 67.
 — — extension of, 70.
 Barrow's, Mr., index for the reciprocator, 177.
 Bases and capitals for columns, 503.
 Bassööläh, the, 7.
 Bead Tools for hardwood and ivory, 298.
 Bearers, distortion in iron, 104.
 — Gap lathe, 72.
 — Iron, 68, 103.
 — lengthening, 182.
 — Oval turner's lathe, 71.
 — Wood lathe, 99.
 Beach chuck, for round wire, 211.
 Bearings, and frames drilled on the surface chuck, 245.
 Bench, turn, 26.
 Bent works, centering, 204.
 Bergeron's bow lathe, 22.
 Besson's pole — 18.
 Bevil Tools, for hardwood and ivory, 296, 306, 463.
 — The turning, 290.
 Billiard Balls, chucking the, 413.
 — — dyeing and polishing, 577.
 — — seasoning, 408.
 — — turning, 406, 419.
 Bits, Cylinder, 311.
 — Pipe, 310, 531, 568.
 — Nose, 278.
 Blanks, for metal screws, 389.
 Bleaching wood, 575.

- Bodmer's, Mr., single cone speed pulleys, 88.
- Boring, backstay to mandrel, 78.
- collars, 129 ; adjustment for drilling, 130.
 - flange, 105.
 - tools for hardwood, 310.
 - — — metal, 361.
 - — — softwood, 278.
- Bow, Arabian lathe driven by the, 9.
- Bowls, turning wooden, 24.
- Box, clutch, slide, lathe, 116.
- Brass and Gunmetal turning, the cylinder, 341.
- — — — the internal cylinder and surface, 361.
 - — — — the surface, 352.
- Brass, tools for, 331.
- turning tools, position of, 339.
- Broach, 361, 363.
- Brunel's, Sir I., expanding arbor, 226.
- Burnishers, 356.
- Burnishing, steel, iron and brass, 357.
- C.
- CALCULATING trains of wheels, 165.
- Callipers, double, 266 ; double side, 266.
- mode of use, 265.
 - proportional, 548.
 - single, 265.
- Calsch for polishing meerschaum, 570.
- Cannel coal, turning in, 495.
- Capitals and bases of columns, 503.
- Carriers, double bar, heart, ring, screw, 197.
- Carving, circular cutters used for, 206.
- Castings, preparation of, brass, 334 ; iron, 333.
- Catgut bands, splicing, 52.
- — variation in length of, 56.
 - driving bands, 51.
 - joined by hooks and eyes, 55 ; Nicholl's, 54.
- Cement chucks for wood and metal, 239, 241, 537.
- Turner's, 239.
- Center, sliding, 194, 506.
- Centers, height of, 91 ; raising the, 179.
- hollow, 193, 279, 354.
 - turning works from several, 201, 203, 204, 252.
- Centering bent works, 204.
- cranks, 201, 203.
 - cylindrical works in metal, 192, 207, 210.
 - scribing tools used in, 202.
 - tools, 194, 195, 196.
 - works in softwood, 189.
- Chair turning, 23.
- Change wheels, Tables of settings of, 164, 167, 168, 169, 173, 177.
- Chinese ball, turning the, 426.
- lathe, 15.
 - pump drill, 4.
- Chisel cutter bar, 143.
- for turning softwood, 258 ; for hardwood and ivory, 294, 421.
- Chord dividers, Ames', 387.
- Chucking, remarks on ; 189, 192, 207—211, 214, 220, 222, 234, 236, 239, 244.
- Chucking, rebates in wood chucks, 483.
- Chucks,
- classified list of, 186 ; diversity in, 185 ; face of, 95, 402 ; their purposes, and adjustment of work, 185 ; truth in, 188.
 - arbor, 221, 238.
 - — for circular cutters, 206.
 - Beach chuck for round wire, 212.
 - Bennett's die chuck, 209.
 - boring bit, 206.
 - Brunel's, expanding arbor, 226.
 - carriers for, 197.
 - cement for metal, 241.
 - cement for wood, 239.
 - Clement's double self-acting driver chuck, and others, 199.
 - cup chucks, 213.
 - diametrical centers in, 559.
 - die with one slide, 209.
 - die with two slides, 208.
 - double cone expanding mandrel, 228.
 - double driver, 200.
 - double screw, and taps for, 237, 405.
 - driver or running center, 196.
 - driving, 213.
 - drum for turning squared forms, 555 ; surface for ditto, 556.
 - Dundas' scroll, 231.
 - expanding arbor, 226.
 - — mandrels, 226—228.
 - face plate. See SURFACE CHUCKS.
 - flange with points, 190.
 - Hick's expanding mandrel, 227.
 - hollow, with pinching screws, 207.
 - metal cup, 213.
 - — spring, 224.
 - Mordan's self-centering for wire, 211.
 - pad, 205.
 - pipe makers, 568.
 - plain metal, 213.
 - — — filled with wood or lead stoppers, 220.
 - — wood, 215, 483.
 - — — with metal flange, 216.
 - prong, 189.
 - radial figuration, for, 558.
 - rectangular vice, 251.

- Chucks,
 — round hole drill, 206.
 — running center, 196.
 — screw arbor, 238.
 — screw worm, 236.
 — spiral, 160.
 — square hole drill, 205.
 — — — for metal, 192.
 — — — for wood, 191.
 — surface at an angle, 250.
 — — counterpoise for, 246, 251.
 — — with clamps, 242.
 — — with dogs for wood and metal, 234.
 — — with fixing blocks, for turning from several centers, 252.
 — taper fluted, 190.
 — universal, with slides and grooves, 228
 — — with two jaws, with simultaneous movement, 233.
 — upright clamp for, 559.
 — — metal, 250.
 — — wood, 248, 503, 568.
 — Willis' disc, 238.
 — wire, with split dies, 213.
 — wood spring, 222.
 — — surface, 240.
 — Yuile's and other expanding mandrels, 227.
- Cinquefoil enrichments, 538.
- Circular form, 1.
 — solids, turned within the sphere, 435.
- Circumference of the sphere, finding the, 416.
- Classified list of chucks, 186.
- Clements, Mr., double self-acting, driver chuck, 199; mandrel, 78; treadle, 50.
- Clockmaker's lathes, 26.
- Clustered columns, 527.
- Clutchbox, slide lathe, 116.
- Columns, 499, 503, 523.
 — annular additions to, 566.
 — attachment of, 500, 504, 523.
 — bases and capitals for, 503.
 — clustered, 527; rusticated, 451.
- Collars, back center mandrels, for, 74.
 — boring, 129.
 — mandrel, 94.
 — mandrel, in cast metal, 61.
 — wooden, 15.
- Combination of many pieces in turning, 91, 446.
- Combined plain turning, 446, 499
- Compasses, proportional, 548.
- Compound solids, turned within the polyhedra, 444; within the sphere, 431.
- Concave and convex curves, hardwood, 326; metal, 355, 358.
- Concave and convex curves, on rectangular sections, 359.
- Conducting apparatus for traversing mandrel, 108.
- Cones and conical turning, hardwood, 320; softwood, 276, 288.
 — — — — metal, 354
- Cones and curves, spiral on, 170.
- Cone pulleys, single driving, 83, 87, 88.
- Construction of turned works, 446.
- Continuous rotation in the pole lathe, 27.
- Contraction in material, 407.
 — in plain and screw fittings, 488.
- Copper, tools for, 331.
- Counterpoise for surface chucks, 246, 251.
- Countershafts, driving, variation of speed from, 87.
- Counting Index, 121; mode of use, 122.
- Cranks, centering, 201, 203.
 — lathe, 45.
- Crossed bands, 44, 86.
- Cubes, 524, 552.
- Cubes and beads, 537, 551.
- Cup chucks, 213.
- Curvatures, long simple, turned in wood, 463, 476; quicker, 464.
 — turned in assigned positions, 465.
- Cutler's hand flywheel, 39.
- Cutter bars, chisel, 143.
 — — external screw threads, 384, 390.
 — — gouge, 143.
 — — grinding the blades of, 143.
 — — internal screw threads, 395.
 — — wood turning, for, 143.
- Cylinder bits, 311.
 — popit head, 104.
- Cylindrical works, in metal, centering and setting, 192.
 — — parallelism in, 264, 303, 343.
- D.
- DARKENING woods, 573.
- Dead center lathes, 44.
- Depth of cut in turning, 259, 301, 336.
- Designs, enlarging or reducing, 548.
- Diamond drills, 349.
 — the, used in turning hardened steel, 347.
 — — — — ballas-bort and carbonate tools, 348.
- Die-chuck with one slide, 209.
 — with two slides, 208.
- Die-chuck, Bennett's, 209.

Dimensions of foot lathes, 92.
 Disc chuck, Willis', 238.
 Distortion in iron lathe bearers, 104.
 Dividing the work, 499, 517, 528, 543, 559.
 Division plate, 109, 118.
 — — interpolation with, 125.
 — — numbers of division upon, 121.
 — — Table of, 124.
 — — scribing tools used with, 127.
 Dodecahedron, turning the, 442.
 Double bevil flywheel, 104.
 — driver chucks, 199, 200.
 — fittings, 517.
 — screw chucks, 237, 405.
 — wood lathe frame, 108.
 Drill, chucks, 205.
 — lathe derived from, 3.
 — pump, 5.
 — reciprocatory motion in, 4.
 Drillbow, Arabian, 9.
 Drilling, boring collar for, 130.
 — centers, in metal works, 194.
 Drills, cylinder bits, 311.
 — diamond, 349.
 — Egyptian, 3.
 — hand, for turning, 312.
 — hardwood, for, 311, 312.
 — pipe, 310.
 — twist, 311.
 — wire, 310.
 Driver chucks, 196.
 Driving bands, Catgut, 51; crossed and with tension pulleys, 56.
 — — — proportions of, 51.
 — chucks, 213.
 — the foot wheel, 35, 37, 255.
 — — — for the traversing mandrel, 378.
 — gear, engineer's, comparison of, 90.
 — pulleys, 85; single cones, 83, 87; used by the Potter, 89.
 — shafts, 86.
 — straps, 84.
 — the spiral apparatus, 174.
 — wheel, 30, 37, 104, 115.
 — — hand, 31, 39, 43.
 Drum for turning squared forms, 555.
 Dutch rush, 471, 474.
 Dyeing ivory, 575.
 — wood, 571.

E.

EARLIEST evidences of turning, 2.
 Early footwheels, 32.
 — mandrels, 58.
 — traversing mandrels, construction of, 59.

Eccentric apertures, turned on the surface chuck, 246, 252.
 — plain turning, for ornament, 537.
 Edge turning, 543, 558.
 Egyptian drills, 3.
 Elizabethan twist, 170.
 Emery paper, 345, 356.
 — sticks, 345, 356, 377.
 Engineer's driving gear, comparison of, 90.
 — lathe bearers, 69, 72.
 — mandrels, 76.
 English back center mandrel, 64.
 Enlarging designs, 548.
 Enrichments in turned works, remarks on, 449.
 — chucks for turning, 537, 539, 559.
 — trefoil, 537; quatrefoil, 538; cinquefoil, 539.
 Equilibrium in the carrier, 198.
 Errors in turned castings, 247.
 Etruscan vases, consideration of outline in, 456, 495.
 Expanding mandrels, 226—228.
 Extension of bar lathe, 70.

F.

FACE of the chuck, 95, 402; of the mandrel, 95, 402.
 Faceplate, backgeared, 81.
 — or surface chucks, 234, 242—248.
 Files used in turning, 344, 353.
 Filing block, for pipe makers, 569.
 Fittings, double, 517; plain, 279, 487, 492, 496; screw, 375.
 Fixing blocks, for turning from several centers, 252.
 Flange chucks with points, 190.
 — for boring, 105.
 Flat tools, for brass, 331, 342, 353; for hardwood and ivory, 295, 307; for iron, 330, 341; reversed position, 356; for softwood, 259.
 Flywheel, double bevil, 104; single bevil, 46; triple bevil, 105, 114.
 Flywheels, hand, 39—43.
 — weighted, 48.
 Foot lathes, dimensions of, 92; modern, 91.
 Footwheel, 32, 37.
 — early, 31.
 Forgings, iron and steel, preparation of, 334.
 Form, circular, 1.
 — in turned works, 448.
 Forms, squared, 503, 510, 524, 537, 551, 554.
 Fox's, Mr., mandrel, 77.
 French traversing mandrel, 62.

G.

GAGE, parallel, 417.

Gage ring, 291, 293, 324, 326.
 — for turning sloping surfaces, 503.
 Gap-lathe bearers, 72.
 Glass-paper, 469, 474; rubbers for, 470.
 Glueing work on the surface chuck, 240;
 paper interposed in, 240, 440, 532.
 Gothic arch, 537.
 Gouge cutter bar, 143.
 — for turning hardwood and ivory,
 294; softwood, 258.
 Granite, turning, 350.
 Gravers for turning iron, 329, 339.
 Greek vases, 456, 495.
 Grinding cutter bar blades, 143.
 Grindstones, turning, 350.
 Guides for slender turning, the hand and
 simple mechanical supports, 132;
 adjusting to the work, 134; Arabian,
 9; Bergeron's, for very slender turn-
 ing, 133; for metal, 133, 135; sliding,
 133, 134; for the slide lathe, 135; for
 use with the ornamental rest, 136.
 Gunmetal, tools for, 331.

H.

HALES', MR., centering tool, 196.
 Hammer correct use of in chucking, 190,
 215, 221.
 — heads, turned, 359.
 Hand driving wheel, 31.
 Hand flywheels, 30, 39—41, 43.
 — — cutler's, 39.
 — — for the turnbench, 43.
 — — wood turner's, 39.
 — Rest, 97.
 — screw tools, 367.
 Handles for grinding cutter bar blades,
 143.
 Hardened steel, turned with the diamond,
 347.
 Hardwood lacker, manipulation with,
 472; colouring with, 473,
 573.
 — polishing, 471, 573.
 Hardwood turning, 294.
 — — armrest, the, 308.
 — — boring and turning,
 the internal cylin-
 der, 310, 313.
 — — boring tools, 310.
 — — concave and convex
 curvatures, 326.
 — — cones and conical
 forms, 320.
 — — cylinder, the, 302.
 — — flat tool on the cylin-
 der, 302; on the
 surface, 307.
 — — position of the turn-
 ing tools, 299.
 — — internal cylinder, the,
 313.

Hardwood turning, internal hemisphere,
 325.
 — — — partingtools,
 used for
 saving the
 material,
 318.
 — — — surface, the,
 316.
 — — removing cores, 317.
 — — speed in, 256.
 — — spherical forms, 321.
 — — surface, the, 305.
 — tools, with curvilinear edges,
 297.
 — — — rectilinear edges,
 295.
 Heart carrier, 197.
 Height of center, 91; raising the, 179.
 Herodotus, on the lathe, 2.
 Hexahedron, turning the, 441.
 Hick's, Mr., expanding mandrel, 227.
 Hollow centers, 193, 279, 354.
 — chucks, with pinching screws, 207.
 Hook tools for softwood turning, 280,
 283.
 Hooks and eyes, catgut joined by, 54.
 Horizontal position of the hardwood and
 ivory tools, 299.
 Holtzapffel, J. J., improvements in lathes,
 73, 75.
 Holtzapffel, Charles, Lathe mandrels, 75;
 Tools and cutter bars, 385, 395; traverse
 of the slide rest, 156.

I.

ICOSAHEDRON, turning the, 442.
 Inclination of the tool in cutting screws
 and spirals, 385.
 Index, use of the, 120, 125.
 — adjusting, 119.
 — counting, 121; mode of use, 122.
 — plain, 118.
 Indian lathe, 6.
 Inlaying for surface ornament, 539;
 — cylindrical works, 540.
 — — Tunbridge ware, 560.
 Inside parting tools, 296, 317.
 Internal back gearing, 113.
 — parting tools, used for hardwood
 and ivory, 318.
 Interpolation, with the division plate, 125.
 Iron lathe bearers, 68, 103.
 — — frames, 106, 110.
 Iron and steel turning, cylinder, the, 339.
 — — — file, the, used on the
 cylinder,
 344.
 — — — used on the
 surface,
 353.

- Iron and steel turning, internal cylinder,
and surface, 360.
— — — — surface, the, 350.
— — — — tools for, 329.
— turning tools, position of, 283, 338.
Ivory, ball teeth and blocks, 408.
— dyeing, 575; preparation of stains
for, 577.
— polishing, 474, 576.
— tools, with curvilinear edges, 297.
— — — — rectilinear edges, 295.

K.

- KILBURN'S, Mr., centering tool, 195.
Keys for cranks, 46.
— — shafting, 90.
— flat, turning the edges of, 359.

L.

- LACKERING hardwood, 472, 573; metal,
337.
Lathe, ancient authors on the, 2, 5, 18, 20,
22, 60.
— Arabian, 8.
— archery bow, 21, 22.
— balustrade turner's, 153.
— bearers, distortion in iron, 104.
— — engineer's, 71.
— — iron, 68, 103.
— — oval turners, 71.
— — sections of, 69.
— carriers, 197.
— Chinese, 15.
— cranks, 45.
— derived from the drill, 3.
— frames, single wood, 99.
— — double wood, 108.
— — iron, 106.
— French traversing mandrel, 59, 62.
— heads, back center, 64, 93.
— — lifting blocks for, 180.
— — traversing mandrel, 75, 106.
— Herodotus on, 2.
— Indian, 6.
— Nasmyth's, Mr., 82.
— Persian, 8.
— Plumier's, 21.
— pole, 17, 19.
— slide foot, 110.
— South American, 15.
— Spanish, 15.
— steel bow, 22.
— taps, 399.
— treadles, 47.
Lathes, position when working, 255; using
the treadle, 37, 256, 378.
— bar, 66; extension of, 70.
— clockmaker's, 25.
— dead center, 44.

- Lathes held in the vice, 26.
— modern foot, 91.
— oil for, 96.
— watchmaker's, 25.
Lead stoppers for plain chucks, 220.
Leftside tools for hardwood and ivory,
295.
Lengthening bearers, 182.
Leverage of the turning tools, 259, 301.
Lifting blocks, 180.
— pieces for slide rest tools, 146.
Loss of time, between the carrier and the
work, 198, 389.
— — in slide rest screw, 142.
— — in screw cutting, 387.
Lubrication in turning the metals, 337.
— of the mandrel, 96.

M.

- MAINSREW of the slide foot lathe,
115.
Mandrels, back center, 64, 95.
— back geared, 79, 110.
— backstay for boring to, 78.
— Clement's, 78.
— collars, 61, 64, 74, 76, 94.
— double cone expanding, 228.
— early, wood and metal, 58.
— early traversing, construction
of, 59.
— engineer's, 76.
— English back center, 64.
— face of the, 95, 402.
— forms of the, 74—78.
— Fox's, 77.
— French traversing, 63.
— Hick's expanding, 227.
— in cast metal collars, 61.
— injury from adhesion, 96.
— lubrication of, 96.
— traversing, 62, 65, 75, 107, 377.
— Tunbridge screw, 65.
— Yuile's expanding, 227.
Marking divisions on the work, 126.
Material, contraction in, 407; in plain
and screw fittings, 488.
Maudslay's, Mr., Bar lathe, 66; Universal
chuck, 234.
Meerscham turning, 570.
Meshrebeeyeh work, Arabian, 10.
Metals, polishing the, 337.
Metal turning, 328.
— — analogies between metal and
wood turning, 328.
— — backstays for, 135.
— — cones, cylindrical and surface
curves, 354.
— — cylindrical works in brass and
gunmetal,
342.
— — — — finishing, 345.

Metal turning, cylindrical works in iron and steel, 339.
 — — — — parallelism in, 343.
 — — — — examples of, accurate triblets, 359.
 — — — — cones and tapering curves, 354.
 — — — — cylindrical works, 345, 346.
 — — — — forms of flat sections, 359.
 — — — — hollow and pointed centers, 355.
 — — — — trumpet moulds and large curves, 358.
 — — — — files used in, 344, 353.
 — — — — hardened steel turned with the diamond, 347.
 — — — — horizontal position of the tools, 339.
 — — — — internal cylinder and surface, 360.
 — — — — lubrication in, 337.
 — — — — milling tools for, 332, 462.
 — — — — preparation of castings and forgings, 333.
 — — — — sequence followed in, 362.
 — — — — speed and depth of cut, 335.
 — — — — surfaces and surface forms, in brass and gunmetal, 352.
 — — — — surfaces and surface forms, in iron and steel, 350.
 — — — — tools for brass and gunmetal, 331.
 — — — — iron and steel, 329.
 — — — — underhand position of the tools, 283, 338.
 Metal works, centering cylindrical works, 192, 207, 210.
 — — — — centering tools for, 195.
 — — — — drilling centers in, 194.
 Momentum, in hand and foot driving wheels, 36.
 Mordan's, Mr., self-centering wire chuck, 211.
 Mouldings, forms and proportions of, 453.
 — — — — positions for, 450, 455.
 Moulding tools, for hardwood and ivory, 298.
 Moxon, hand flywheel, 30; on the foot wheel, 35—37; pole lathe, 18.
 Multiplex threads, and spirals, 174, 337, 397.

N.

NASMYTH, MR., lathe by, 82.
 Nicholl's, Mr., hooks and eyes, 54.
 Nuts and internal screw threads, 396.

O.

OCTAHEDRON, turning the, 442. †
 Oil, animal, preferable for lathes, 96.
 Ornament in turned works, 449, 451.
 Ornamental turning, backstay for, 136.
 Outline, in turned works, 448; in the Etruscan Vases, 456.
 Oval turner's lathe bearers, 71.
 Overhand position of the softwood tool, 260.

P.

PAPER emery, 337, 345, 356.
 — — — — glass, 469, 474.
 — — — — used in turning, 219, 240, 394, 437, 440, 532.
 Parallel gage for spheres and cylinders, 417.
 Parallelism, in cylindrical works, 264, 303, 343.
 Parting tools for hardwood and ivory, 296, 317; for softwood, 259, 272.
 — — — — internal, 296, 318.
 Persian lathe, 8.
 Pickling castings and forgings, 333.
 Pin, tail, 78.
 Pipe bits, 310, 531, 568.
 Pipes, tobacco, 567.
 — — — — chucks for turning, 568.
 Plain chucks, 213.
 — — — — angle of fitting in, 217, 221, 483.
 Plain fittings or joints, 279, 487, 492, 496; contraction in, 488.
 Plain index, 118.
 — — — — popit head, 96.
 Plain turning, eccentric and inlaying, 537, 539.
 — — — — simple and combined, 446.
 — — — — slide-rests for, 137, 139.
 Plankways, turning, 273, 484; square work, 551, 553.
 Plate, division, 109, 118.
 Plumier's lathe, 21, 33, 60.
 — — — — on the lathe, 5.
 Point tools, for brass, 331, 352; for hardwood and ivory, 296, 305; for iron, 330, 366.
 Pole lathe, Bergeron's, with bow, 22.
 — — — — Besson's, 18.
 — — — — continuous rotation in, 27.
 — — — — Moxon's, 18.
 — — — — Schopper's, 17.
 Polishing, amber, 570.
 — — — — billiard balls, 425, 576.
 — — — — hardwood, 471; with lacker, 472, 573.
 — — — — ivory, 474.
 — — — — meerschaum, calsch for, 570.
 — — — — metals, the, 337.

- Polishing softwood, 470.
 Polygonal system for turning spherical forms, 290, 321.
 Polyhedra, compound solids turned within the, 444.
 — produced from the sphere, 438.
 — subdivision into shells, 443.
 Pompeian Tripods, 547.
 Popit head, cylinder, 104.
 — — plain, 96.
 Position of the brass turning tools, 339.
 — — tools, horizontal for hardwood and ivory, 299.
 — — iron turning tools, 283, 338; overhand, 356.
 — — softwood tools, overhand, 260; underhand, 283.
 Position when working the lathe, 255.
 Potter's, the, single cone speed pulleys, and other modes of driving, 89.
 — wheel, the, 2.
 — — — driven by the foot, 29.
 Prime numbers, obtained with the adjusting index, 125.
 Profile turning, tools for, 560.
 Prong chuck, 189.
 Proportional callipers, 548.
 — compasses, 548.
 Proportions of driving bands, 51.
 — in outline, 448.
 — relative variation of, in turned works, 548.
 Pulley, speed, 38.
 Pulleys, driving, 85.
 — single cone, 88.
 — and driving bands for spirals, 152.
 — for traversing the slide rest, 155.
 Pump drill, 4.
- Q.
- QUANTITY in ornament, 449.
 Quarrying with the diamond drill, 349.
 Quarter round tools for hardwood and ivory, 297, 299.
 Quatrefoil enrichments, 538.
- R.
- RADIAL arm, 115, 160.
 Radial figuration of cylindrical works, 558.
 Rebates turned upon and within wood chucks, 483.
 Re-chucking, 217.
 Reciprocator, Atkinson's, 175.
 Reciprocatory motion in the drill, 4.
 Reducing designs, 548.
 Regular solids, produced from the sphere, 438.
 Rest, back, 20.
 Rest for hand turning, 97.
 — slide, 137, 142.
 — tees, or banks, 97; dividing tee, 127.
 Rightside and leftside tools for hardwood and ivory, 295, 306, 314.
 Ring carrier, 198.
 — gages, 291, 293, 324, 326.
 Rings, in combined turning, 505, 509, 544, 547.
 — cut out, with internal parting tools, 318.
 Round tools for brass, 331, 356; hardwood and ivory, 296, 325; iron, 330, 355.
 Routing tools for brass, 331, 341.
 Royffe's, Mr., square turning, 557.
 Rubbers used in polishing, 472.
 Running center chuck, 196.
 Rush, Dutch, 471, 474.
- S.
- SCHOPPER'S pole lathe, 17.
 Screw carrier, 198.
 Screw cutting, action of the hand tools, 368.
 — — blanks for metal screws, 389.
 — — by bands and pulleys, 152.
 — — cutting screws with the hand tools and traversing mandrel, 377.
 — — cutting softwood screws with the traversing mandrel, 381.
 — — cutting screws with the traversing mandrel and tool in the slide rest, 380.
 — — mandrel screws in chucks, consideration of, 403.
 — — mandrel screws in metal chucks, 402.
 — — mandrel screws in wood chucks, 399.
 — — multiplex threads with the hand tools, 377.
 — — pace with the hand tools, 369.
 — — striking and chasing external wood screws, with the hand tools, 371.
 — — striking and chasing internal wood screws, with the hand tools, 373.
 — — striking and chasing metal screws, 376.
 — — traversing mandrels for, 75, 107.
 — — Tunbridge mandrel for, 65.

- Screw cutting with the slide lathe and spiral apparatus, 383.
 — — backlash in, 387, 389.
 — — external threads, 390.
 — — inclination of the tool, 385.
 — — internal threads, 395—397.
 — — multiplex threads, 174, 397.
 — — re-adjustment of the tool, 393.
 — — tools and cutter bars for external threads, 384, 390.
 — — tools and cutter bars for internal threads, 395.
- Screw guides, 108.
 — joints and fittings, 375, 518.
 — threads, 368.
 — tools, hand, 367.
 — worm chuck, 236.
- Scribing tools, used with the division plate, 127.
 — — — in centering, 202.
- Sections of lathe bearers, 69.
- Sequence in turning, 362, 479, 488.
- Setting cylindrical works in metal, 192.
- Shafts, driving, 86.
- Simple plain turning, 446, 460.
- Singapore ball, the, 433.
- Single cone speed pulleys, 83 ; Bodmer's, 88 ; the potter's, 89.
- Slender turning, 133, 564.
 — — Arabian support for, 9.
 — — guides for, 132—137.
- Slide foot lathe, 110 ; backgear, 113 ; backlash in screw cutting, 387 ; backstays, 135 ; clutch box, 116 ; driving wheel, 114 ; inclination of screw tools, 385 ; internal gearing applied to, 113 ; mainscrew of, 115 ; partially balanced treadle, 115 ; tables of change wheels for, 168, 169 ; saddle plate and slide rest, 115.
- Slide rest, 137, 142.
 — — adjustment of, 149.
 — — adjustment of tool to center, 145.
 — — cutter bars for wood, 143.
 — — lifting pieces for, 146.
 — — manipulation of, 148.
 — — necessary truth in, 138.
 — — screw, wear in, 141.
 — — toolholder, Professor Willis', 139.
 — — tools, 144.
 — — traverse of tool, 146.
 — — traversed by bands and pulleys ; cam and lever, &c., 155.
 — — — by more complete apparatus, 156.
- Sliding center, 194, 506.
- Sliding guides, metal and wood, 132—137 ; for ornamental slide rest, 136 ; for slide lathe, 135.
- Softwood, polishing, 470.
 — speed for turning, 256.
 — tools for external turning, 257.
 — — — internal — , 280.
- Softwood turning ; 254.
 — — back surface with gouge and chisel, 271.
 — — boring tools, 278.
 — — boring and turning the internal cylinder, 278.
 — — centering works in, 279.
 — — cones and conical surfaces, 276, 476.
 — — cylinder with the chisel, 262.
 — — cylinder with the gouge, 260.
 — — cylinder and surface, plankways, 273, 484.
 — — external tools for, 258.
 — — formation of plain fittings, 279.
 — — hollowing with the gouge, 281, 292.
 — — hollowing with the hook tools, 283, 292.
 — — internal cone, the, 288.
 — — internal cylinder, with the hook tools, 283.
 — — internal cylinder, with the side tools, 285.
 — — internal hemisphere, 292.
 — — internal surface, the, 286.
 — — internal tools, for, 280.
 — — overhand position of the tools, 260.
 — — parting tool, the softwood, 272.
 — — spherical forms, 288.
 — — surface with the chisel, 269.
 — — — with the gouge, 267.
- Solid profiles, 560.
- South American lathe, 15.
- Spanish lathe, 15.
- Speed in metal turning, 335.
 — in turning hard and softwood, 256
 — pulley, 38.
 — — single cone, 83, 89.
 — — — — Bodmer's, 88.
 — variation by countershaft, 87.
- Sphere, the accurate, 406.
 — Chinese ball, 426.

- Sphere, Chinese ball, chuck and tools for, 427; manipulation of, 428.
- chucking the billiard ball, 413.
 - compound solids, within the polyhedra, 444.
 - equidistant division of the surface, 439.
 - finding the circumference of the, 416.
 - ivory ball teeth and blocks, 408.
 - polyhedra divided into shells, 443.
 - polygonal system of turning, the, 290, 321.
 - preparation and selection of the material, 407.
 - — — of billiard balls, 411.
 - regular solids produced from the, 438.
 - Singapore ball, 433.
 - turning circular solids within the, 435.
 - — — compound solids within the, 431.
 - — — the billiard ball, 419.
 - — — — — tools for, 420.
- Spiral apparatus, 157; the principle of, 161; details of, 159.
- — — adjustment of, 162.
 - — — driving, the, 174.
 - — — Elizabethan twist, 170.
 - — — surface, cones, and curves, for, 170.
- Spiral apparatus, Tables of settings of change wheels, 164, 167, 173.
- Spiral arbors, 161.
- chuck, 160.
 - on cones and curves, and surface, 179
- Splicing catgut bands, 52.
- Spring chucks, wood, 222; metal, 223.
- Square hole chuck, 191.
- Square, The, turning, 316.
- the, triangular steel, 316.
- Squared forms, 503, 510, 524, 537, 551; turned with convex faces, 554.
- Staining wood, 571.
- Steelbow lathe, 22.
- Steel, tools for, 329.
- triangular squares, 316.
 - turned with the diamond, 347.
- Stops, and appliances for surface chucks, 242, 244.
- Straight edge used in turning, 268, 343.
- Straps driving, 84.
- Striae in brass turning, 342, 353.
- Surface chucks, 239.
- Surface chucks with dogs, 234; with clamps, 242; counterpoise for, 246, 251.
- Surface spiral apparatus, 170.
- turning, truth in, 270, 276, 307, 352.
- T.
- TABLE of divisions of the circle, 124.
- — — settings of change wheels, 164, 167, 168, 169, 173, 177.
- Tabular view of turned works in wood and ivory, 458.
- Tailpin, 78.
- Taper fluted chucks, 190.
- Taps for double screw chucks, 237.
- lathe, 399.
- Tees or banks, for hand rest, 97.
- Tests for adjustment of slide rest, 151.
- Tetrahedron, turning the, 439.
- Thebes, turning from, 2.
- Threads, multiplex, 174, 377, 397.
- Tinctures used in dyeing and staining, 572.
- Tool handles, hardwood, 463; softwood, 460.
- Tools, bead, 298.
- billiard balls, for turning, 420.
 - brass and gunmetal, 332.
 - hand screw, 367.
 - hardwood and ivory, horizontal position for, 299.
 - hardwood and ivory, with curvilinear edges, 297; with rectilinear edges, 295.
 - hook for softwood, 280.
 - horizontal position for Brass turning, 339.
 - iron and steel, for, 329, 351.
 - leverage of the turning, 259, 301.
 - milling, 332.
 - moulding, 298.
 - overhand position of the softwood tools, 260.
 - profile turning, 560.
 - screw for metal and wood, 367.
 - — — for softwood, 381.
 - screw threads, cutter bars for external, 384, 390.
 - — — — — internal, 395.
 - scribing for base lines, 202; with division plate, 127.
 - slide rest, for, 144.
 - softwood, external turning, for, 257.
 - — — internal, — — — 281.
 - — — parting, 272.
 - — — underhand position of some, 283.
 - underhand position for metal, 283, 338.
- Trains of wheels, methods of calculating, 165.
- Transparent turning, 562.
- Traversing mandrels for screw cutting, 75, 107; French, 62.
- — — conducting apparatus for, 108.
 - lathe head, 106; manipulation of, 378.

- Treadle, Clement's, 50.
 — using the, 256, 378.
- Treadles, exceptional, 49.
 — lathe, 47.
 — partially balanced, 115.
- Trefoil enrichments, 537.
- Triangular steel squares, 316.
- Triblets for silver flutes, 359.
- Triform plinths and pieces, 513, 527, 531.
- Triple bevil flywheel, 105, 114.
- Tripods, Pompeian, 547.
- Trumpet moulds, 358.
- Truth in chucks, 188.
 — — slide rest, 138.
 — — surface turning, 270, 276, 307, 352.
- Tunbridge screw mandrel, 65.
 — ware, inlaying, 560.
- Turnbench, 26.
 — hand flywheel for, 43.
- Turned mouldings, 453.
 — works, construction of, 446; enrichments in, 449; fittings or joints in, 487, 492, 496; left rectangular, 551; ornament in, 449; outline in, 448; portions of rings, 505, 509; positions for mouldings, 450, 455; radial figuration of, 558; rectangular, with convex faces, 554; simple forms, 461-469.
- Turned works, Designs for:—
 Amphora, 513.
 Ash trays, 480.
 Banner screens, 495.
 Black bot le stands, 480.
 Bouquet holders, 487.
 Branches and arms, 505, 509, 543-548.
 Candelabra, 544.
 Candle shades, 495, 509.
 Candlesticks, 491.
 Cannel coal, 495.
 Chandeliers, 543.
 China, stands for, 523.
 Columns, 499, 523; clustered, 527; inclined, 503; rusticated, 451; annular additions to diameter, 566.
 Crosses, 553.
 Cubes, 524, 553.
 Egg cups, 475.
 Epergnes, 527.
 Etruscan vases, 495.
 Flour sifters, 484.
 Flower holders, 475.
 Flowerpot stands, 531.
 Handles for vases, 509, 510.
 Hardwood tool handles, 463.
 Inkstands, 509.
 Jardinières, 543.
 Match pots, 475.
 Menu holders, 523.
 Mouldings, 453.
- Turned works, Designs for:—
 Ninepins, 464.
 Pin trays, 480.
 Pipes in wood and meerschaum, 567.
 Pompeian Tripods, 547.
 Salt cellars, 475.
 Slender stems, 564.
 Softwood tool handles, 460.
 Sovereign boxes, 488.
 Spill pots, 475.
 Stands for China, 523.
 String boxes, 484.
 Sugar sifters, 484.
 Table-ware, 524.
 Temples, 517.
 Tobacco pipes, 567; meerschaum, 569.
 Toilet boxes, 484, 488.
 Transparent, in wood and ivory, 562.
 Triform plinth, 513; pieces, 527.
 Tripod Flower vase, or Statuette stands, 547.
 Tripod lamp stands, 547, 549.
 Vases, 492, 496, 510.
 Wall mirrors, 532.
 Watch stands, 499, 505.
 Wax taper holders, 491.
- Turner's balustrade lathe, 153.
 — cement, 239.
- Turning, amber, 570.
 — ancient authors on, 2, 5, 18, 20, 22, 30, 35, 60.
 — bevil, The, 290.
 — billiard balls, 406, 419.
 — bowls, wooden, 24.
 — brass mandrel pulley, 363.
 — chairs, 23.
 — cubes, 552.
 — cylindrical works, with the slide rest, 148.
 — earliest evidences of, 2.
 — eccentric ornament in plain, 537.
 — granite, 350.
 — grindstones, 350.
 — hardwood, 294.
 — inlaying on surface and edges, 539, 560.
 — ivory, 294.
 — long simple curves in wood, 463, 476; quicker curvatures, 464; curves in assigned positions, 465.
 — meerschaum, 570.
 — metal, 328.
 — paper used in, 219, 240, 394, 437.
 — plankways, 273, 484.
 — sequence in, 362, 479, 488.
 — serrated edges, 543, 558.
 — softwood, 254.
 — square, The, 316.
 — square forms with convex faces, 554.

Turning square work, 552; portions left rectangular, 551.
 — Thebes, from, 2.
 Twist drills, 311.
 — Elizabethan, 170.

U.

UNCHUCKING, 219.

Underhand position of the metal turning tools, 283, 338.
 — — of some softwood tools, 283.

Universal chucks, 228.

— — Dundas, scroll, 231.
 — — with three slides and jaws, 228.
 — — with two jaws, moved simultaneously, 232.

Upright chucks, wood, 248.

— — metal, 251.
 — — clamp for, 559.

V.

VARIATION in length of catgut bands, 56.
 — in dimensions of turned works, 548.

Varnishing turned works, 474, 573.

Vases, Etruscan and Greek, 456, 495.

— pierced handles for, 510.
 — turned handles for, 509.

Vibration in brass turning, 342, 353.

— in screw cutting, 390.
 — in slide rest tools, prevention of, 146.

Vice, lathes held in the, 26.

— chuck rectangular, 251.

W.

WATCHMAKERS' lathes, 25.

Wear in slide rest screw, 141.

Weighted flywheel, 48.

Wheels, backlash in, 387.

— calculating trains of, 165.

— foot, 31, 37, 46, 104, 115.

— momentum in, 36, 38.

— Moxon on, 30, 35.

— potter's, the, 2; driven by the foot, 29; by other means, 88.

— single bevil flywheel, 46; double, 104; triple, 105, 114.

— speed pulley, 38.

— used with Atkinson's reciprocator, 176

— driving the foot, 35, 37, 255.

— — — for the traversing mandrel, 378.

Willis', Professor, disc chuck, 238; tool holder for slide rest, 139.

Wire chuck, Mordan's, 211.

— — with split dies, 213.

Wood bearers, 98.

— bleaching, 575.

— bowls, 23.

— chucks, plain, 215, 483; large with metal flange, 216.

— chucks, spring, 222.

— darkening, 573.

— lathe frame single, 100, 102; double, 108.

— preparation of stains for, 573.

— staining, 571.

— tobacco pipes, 567.

— turner's hand flywheel, 39.

Y.

YUILE's expanding mandrel, 227.

THE END.

WORKS PUBLISHED BY HOLTZAPFFEL CO.

64, Charing Cross, and 127, Long Acre, London.

THE ART OF DOUBLE COUNTING ON THE LATHE.

By MAJOR JAMES ASH.

A Clear and Practical Treatise on the Production of an Extensive Variety of Patterns, Ellipses, Triangles, Squares, Pentagons, Hexagons, and Octagons, 3, 4, 6, and 8 Looped-figures, and others of a more Complex character, by means of the ordinary Eccentric Chuck used in combination with the Division Plate, and the Eccentric and the Elliptical Cutting Frames. With an Appendix by JOHN JACOB HOLTZAPFFEL, Assoc. M. Inst. C.E., &c. 8vo, cloth, 74 Illustrations, price 12s. 6d.

ECCENTRIC TURNING.

By N. B. ENGLEHEART.

A Concise Treatise on Eccentric Turning, to which are added Practical Observations on the Uses of the Eccentric Cutting Frame, the Drilling Frame, and the Universal Cutting Frame. Illustrated by Figures and Eccentric Patterns, with full Instructions as to the Modes by which such Patterns may be effected. Quarto, cloth, 50 Illustrations, price 21s.

NOTES ON THE EPICYCLOIDAL CUTTING FRAME.

By THOMAS SEBASTIAN BAZLEY, M.A.

With special reference to its Compensation Adjustment, and with Numerous Illustrations of its capabilities. 8vo, cloth, 111 Illustrations, price 15s. 6d.

INDEX TO THE GEOMETRIC CHUCK.

By THOMAS SEBASTIAN BAZLEY, M.A.

A Treatise upon the Description in the Lathe of Simple and Compound Epitrochoidal or Geometric Curves. 8vo, cloth, 3500 Illustrations, price 42s. The impression of this work consists of 150 copies only, and as the lithographic stones were obliterated as the successive transfers were completed, the book cannot be reprinted. *A few copies only now remain on hand.*

DESCRIPTIVE CATALOGUE OF THE WOODS

COMMONLY EMPLOYED IN THIS COUNTRY, FOR THE MECHANICAL
AND ORNAMENTAL ARTS.

INTERSPERSED WITH EXTENSIVE BOTANICAL NOTES BY DR. ROYLE, F.R.S., L.S.,
AND G.S., ETC., ETC.

8vo, cloth, price 2s. 6d.

A NEW SYSTEM OF DECIMAL GAGES OR MEASURES

FOR SHEET METALS, WIRES, AND SMALL MANUFACTURED ARTICLES GENERALLY.

Including the exact decimal values of the gages now principally used for these purposes in the Mechanical Arts. Pamphlet 8vo, in wrapper, price 1s.

PRINTING APPARATUS FOR THE USE OF AMATEURS.

Containing full and Practical Instructions for the use of COWPER'S PARLOUR PRINTING PRESS, also the description of larger presses on the same principle, and various other apparatus for the Amateur Typographer.

The pamphlet contains, likewise, numerous specimens of types, brass rules, checks, borders, ornaments, corners, arms, &c. 8vo, cloth, price 2s. 6d.

HOLTZAPFFEL AND CO.'S GENERAL CATALOGUE

OF LATHES, TOOLS, AND INSTRUMENTS EMPLOYED IN THE MECHANICAL ARTS.

Stereotype Edition. 8vo, pp. 72, price 6d., or free by post, 8d.

HOLTZAPFFEL & CO.,

N^o. 64,

CHARING CROSS, LONDON,

ENGINE, LATHE, & TOOL MANUFACTURERS,

AND

GENERAL MACHINISTS.

TURNING, PLANING, SCREW AND WHEEL CUTTING, FRAMING, &c.
IN METAL AND WOOD TO DRAWINGS OR MODELS.

Amateurs

ARE SUPPLIED WITH THE APPARATUS, TOOLS, AND MATERIALS, THAT ARE REQUIRED
IN TURNING AND THE MECHANICAL ARTS GENERALLY, AND ARE
ALSO PRACTICALLY INSTRUCTED IN THEIR USE.

Tools and Instruments for

ARCHITECTS.	COPPERSMITHS.	MASONS.	SEAL ENGRAVERS.
BOOKBINDERS.	ENGINEERS.	MILLWRIGHTS.	SILVERSMITHS.
BRUSHMAKERS.	ENGRAVERS.	MODELLERS.	SMITHS.
BUILDERS.	GARDENERS.	OPTICIANS.	SURVEYORS.
CABINETMAKERS.	GUNMAKERS.	PAINTERS.	TINSMITHS.
CARPENTERS.	HARNESMAKERS.	PLASTERERS.	TURNERS.
CARVERS.	HATTERS.	PLUMBERS.	WATCHMAKERS.
CLOCKMAKERS.	JEWELLERS.	PRINTERS.	WHEELWRIGHTS.
COACHMAKERS.	MACHINISTS.	SADDLERS.	WIREDRAWERS.

Cutlery of every Description.

AN EXTENSIVE ASSORTMENT OF
TOOL CHESTS, DRESSING CASES, DRAWING AND MEASURING INSTRUMENTS,
PRINTING PRESSES, GARDEN TOOLS, &c.

MANUFACTORY, 127, LONG ACRE.

FOREIGN ORDERS RECEIVED, EITHER DIRECT OR THROUGH AGENCY HOUSES, EXECUTED
WITH EXACTNESS AND DISPATCH.

SECTION II.—FOLIO FOOLSCAP PRESSES AND APPARATUS.

FOLIO FOOLSCAP PRINTING PRESS, on the principle of Cowper's Parlour Press, suitable to printing the half sheet of foolscap, or the quarto sheet of imperial. With an iron bed half an inch thick, planed quite level and true, to increase the permanent accuracy of the Foolscap Press, and an iron counterpoise to facilitate the working of the same. Measurement of the bed, 15 by 10 inches. The press varnished and japanned, complete, with two iron chases, register points, &c.

LARGE DEAL TYPE CASE, with six drawers, and measuring externally 24 inches by 18, and 11 inches high, with iron handles, lock and key. Four of the drawers are partitioned after the Printer's method for holding 9000 types of the following varieties.—**GREAT PRIMER ROMAN**, Specimen No. 9—viz., capitals, figures, points, spaces and quadrats. **PICA ROMAN**, No. 13; large and small capitals, lower case (small letters), with accented vowels for printing the foreign languages, figures, points, spaces, quadrats, and space-line leads, complete. **BOURGEOIS ROMAN**, No. 17; capitals, figures, points, spaces and quadrats. **BOURGEOIS ANTIQUE**, No. 23; capitals, figures, points, spaces and quadrats. Two of the drawers contain space-line leads, furniture, side and footsticks, quoins, and reglet; also a mallet, shooting-stick, planer, bodkin, printer's composing stick 9½ inches long, brush for cleaning the type, a pair of thick damping slates, &c., all proportioned to the size of the Foolscap Press. Six-inch vulcanized inking roller, in frame and case, and large box of superfine printing ink.

Total charge for the Folio Foolscap Press and Apparatus in the less complete form, £22.

FOLIO FOOLSCAP PRINTING PRESS, exactly like the one last described.

LARGE DEAL TYPE CASE with eight drawers, similar to the case with six drawers above described, but three inches higher, and containing a considerably greater supply of each of the kinds of type specified in the foregoing description, together with the addition of Great Primer No. 9, lower case letters, Pica Italic No. 14, capitals, lower case letters, points and spaces, and Bourgeois Antique No. 23, lower case letters, making the total number of types about 17,000; together with a proportionate increase of space-line leads, furniture, &c., and with the addition of 21 pieces of brass rule of three varieties; six-inch vulcanized inking roller, in frame and case; large box of superfine printing ink; composing frame of deal, to receive the drawers of the type case when in use; inclined galley of mahogany, with moveable bottom; and four extra chases, two of them with crosses.

Total charge for the Folio Foolscap Press and Apparatus in the more complete form, £32.

LARGER PRESSES ON THE SAME PRINCIPLE.

FOLIO DEMY PRINTING PRESS, with iron bed and counterpoise; suitable to printing the half sheet of demy. Measurement of the bed 20 by 13 inches. The press varnished and japanned, complete, with two chases, register points, &c., £15

BROADSIDE FOOLSCAP PRINTING PRESS, made entirely of iron, and provided with screw adjustments to regulate the pressure as required; suitable to printing the whole sheet of foolscap. Measurement of the bed, 20 by 15 inches, complete, with four chases, register points, &c., £22.

Type cases of various sizes, and with any required selection of types. Moulds for casting rollers. Tools, &c., to order.

SECTION III.—CASES FOR ADDITIONAL TYPES.

SMALL TYPE TRAY, 10 by 6 inches, with a selection of about 600 Roman or Italic types, of small size, of either of the numbers 17 to 20, £1.

TYPE BOOK, 15 by 12 inches, with a selection of about 1,500 types, comprising eight varieties of small types for headings, cards, &c., as described in page 55 of pamphlet, £2 10s.

LARGE TYPE TRAY, 22 by 24 inches, partitioned after the mode of the printing office, for containing larger quantities of type of any kind, 7s.

HAND CHASE, in a painted case, with cushion, roller, ink, and inking tray, £1 5s.

PRINTING APPARATUS FOR THE USE OF AMATEURS.

A pamphlet containing full and practical instructions for the use of COWPER'S PARLOUR PRINTING PRESS, also the description of larger presses on the same principle, and various other apparatus for the Amateur Typographer.—The pamphlet contains likewise numerous specimens of plain and ornamental types, brass rules, checks, borders, ornaments, corners, arms, &c. &c.

Third Edition, greatly enlarged. 8vo, cloth, price 2s. 6d.

EPICYCLOIDAL CUTTING FRAME,

FOR PRODUCING COMPOUND FIGURES WITH INTERNAL OR EXTERNAL LOOPS
OR CUSPS.

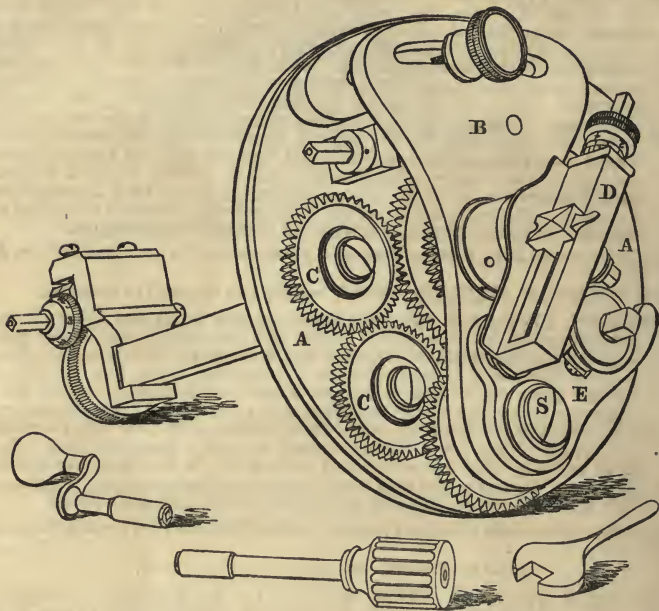

MADE BY

HOLTZAPFFEL & CO.,

64, CHARING CROSS, AND 127, LONG ACRE, LONDON.

THE EPICYCLOIDAL CUTTING FRAME is an extension of the principle of the Elliptical Cutting Frame to adapt the instrument to the production of patterns more nearly resembling the figures made by the Geometric Chuck.

The Epicycloidal Cutting Frame, as usually supplied, will produce about 40 figures of from 2 to 90 loops, every one of which admits of considerable variety both of size and proportion, and if desired at any subsequent time, the number of patterns may be considerably increased.

Nearly the whole of the figures belong to the class of epicycloids in which every loop overlaps or extends beyond the preceding loop. These patterns are very effective, and admit of considerable variation in form and dimensions, by simple change of excentricities. All the patterns consist of a single line, and many of them may be easily made to cover a surface of from 3 to 3½ inches diameter.

To facilitate the manipulation of the Epicycloidal Cutting Frame, it has been so arranged that the settings required to produce the entire series of patterns are limited to the exchange of two wheels upon one arbor, which may be readily detached and re-instated without difficulty. All the patterns produced by the Elliptical Cutting Frame may be produced on a more extended scale by the Epicycloidal Cutting Frame.



Eccentric Chuck.



Oval Chuck.



Two Eccentric Movements.

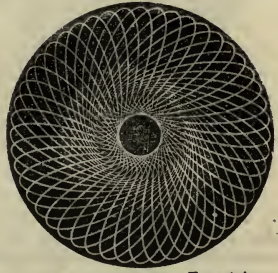

One Oval and one Eccentric.



Segment Engine.



Rectilinear Chuck.

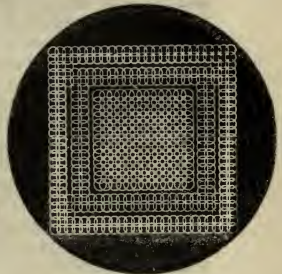

Rectilinear Chuck.



Rose Engine.



Reciprocator.

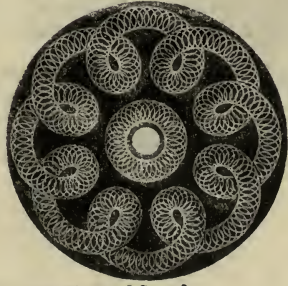

Ibbetson's Geometric Chuck.—Parts First and Second.

COWPER'S PARLOUR PRINTING PRESS.

MADE ONLY BY HOLTZAPFFEL & CO.

64, CHARING CROSS, AND 127, LONG ACRE, LONDON.



This little Printing Press is made of mahogany, and stands in the small space of 11 by 8 inches. It is capable of printing a page 7 by 6 inches, and works so easily that a child may use it on the parlour table. A small type case accompanies it, containing a fount of about 2,500 types, neatly arranged in three drawers with appropriate divisions; a fourth drawer serves for the furniture, inking tablet, &c.; and to these are added the necessary tools, so as to render the whole complete. Should it be required, the type case will contain a duplicate supply of type in addition to that usually furnished, and which doubles the efficiency of the apparatus at a slight additional cost.

The above apparatus is well adapted for the amusement and education of youth, and also to various applications of the inestimable typographic art to the common concerns of mankind.

For example.—Companies, institutions, and individuals, have found it convenient for circular letters, invoices, and papers, subservient to the dispatch and methodical arrangement of business; naturalists and travellers for short memoirs of scientific researches, or labels for specimens; the friends of education for disseminating original and other papers; wood-engravers for examining the progress of their blocks; practical printers, for proofs of title-pages, stereotype plates, or cards; and nearly every different pursuit will suggest some new application of this little Press.

LIST OF PRICES.

SECTION I.—COWPER'S PARLOUR PRESSES AND APPARATUS.

COWPER'S PARLOUR PRINTING PRESS, with a galley-chase, a box of ink, a vulcanized inking roller, and a distributing tray.

SMALL DEAL TYPE CASE, painted, with four drawers; three of them partitioned to contain an assortment of about 2,500 types, and a proportionate supply of leads and brass rule; the fourth drawer contains galleys, furniture, side and foot sticks, quoins, &c.

SET OF EXTRAS—comprising transfer composing stick, bodkin, forceps, mallet, shooting-stick, planer, brush, and turpentine for cleaning the type, two quires of demy printing paper, cut into suitable sizes for the press, and one pair of damping slates.

GALLEY CHASE seven inches square inside.

Total charge for the Plain Parlour Press and Apparatus complete, £6.

COWPER'S PARLOUR PRINTING PRESS, japanned, and finished in the best manner, and fitted with a drawer, in other respects as above.

SMALL MAHOGANY TYPE CASE, with brass lock and handles, in other respects as above.

SET OF EXTRAS, comprising transfer composing stick, &c., as above.

GALLEY CHASE seven inches square inside.

Total charge for the Best Parlour Press and Apparatus complete, £8.

DUPLICATE SET OF 2,500 TYPES, and which may be contained in either of the above cases, £1 12s.

DIAGRAMS ILLUSTRATING THE EPICYCLOIDAL CUTTING FRAME.

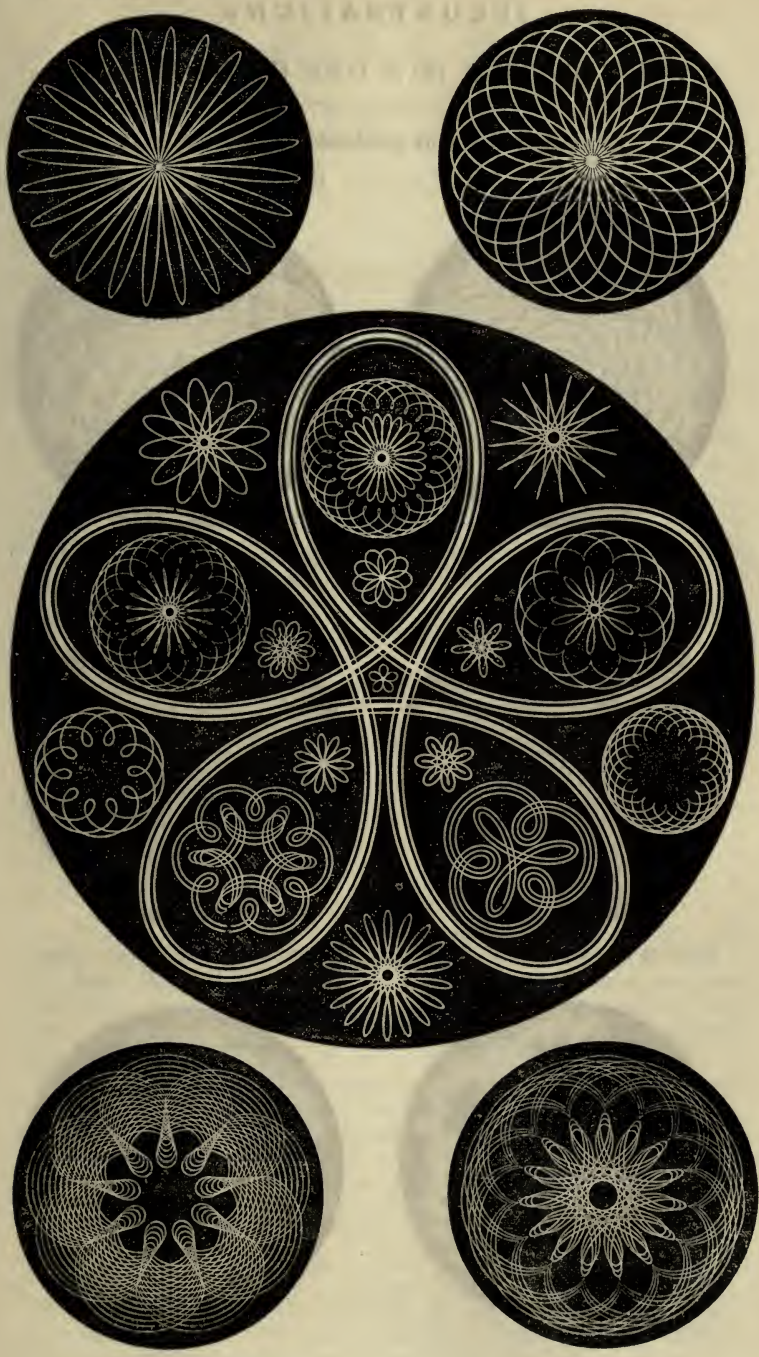

ILLUSTRATIONS
OF
HOLTZAPFFEL & CO.'S ROSE CUTTING FRAME.

Compound Patterns produced from Rosette D.

ROSETTE D, *with Stop.*



ROSETTE D, *with Tangent Screw.*



ROSETTE D, *with Slide Rest Movement.*



ROSETTE D, *with Tangent Screw and Slide Rest Movement.*

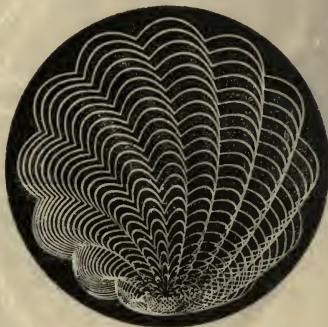

ROSETTE D, *with Division Plate of the Lathe.*



ROSETTE D, *with Division Plate, and Slide Rest Movement.*



ROSE CUTTING FRAME

For Producing Rose Engine Patterns

IN ORDINARY TURNING LATHES,

MADE BY

HOLTZAPFFEL & CO.,

ENGINE, LATHE, AND TOOL MANUFACTURERS,

64, CHARING CROSS, & 127, LONG ACRE, LONDON.

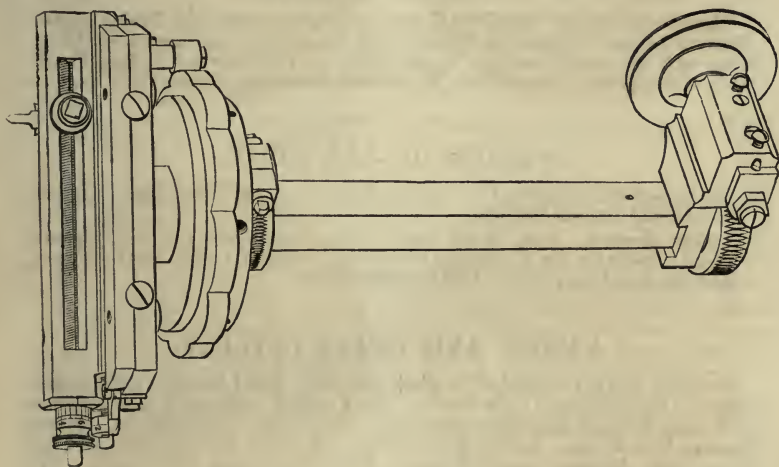

THIS Instrument is employed in the sliding rest in the same manner as the Eccentric Cutting Frame, and its management is almost as simple. It is capable of producing upon *surfaces*, nearly the whole of the ornamental patterns that have been hitherto confined to the Rose Engine, the use of which has been much retarded by the expense and size of the machine, and the numerous apparatus required for its development.

A more compact and less expensive apparatus for Rose Engine Turning has long been a desideratum with Amateurs. HOLTZAPFFEL & Co. have therefore much pleasure in submitting the present instrument to the notice of their patrons.

The variety of the ornamental patterns produced by the Rose Cutting Frame, is limited solely by the number of rosettes; these may be increased to any desired extent, but as the instrument admits of numerous variations being produced from one rosette, only a moderate number will generally be required.

In illustration of the performance of this instrument, six simple patterns, from six different rosettes, are printed on the opposite page, and on the following, six variations of one of these rosettes; many other patterns may be produced from the same rosette, and in those offered, it will be observed that only the most simple apparatus have been employed in combination with the Rose Cutting Frame.

LIST OF GENERAL CUTLERY,

OF THE BEST QUALITY, PLAIN, MEDIUM, AND HIGHLY
FINISHED, MADE BY

HOLTZAPFFEL & CO.,

64, CHARING CROSS, and 127, LONG ACRE,
LONDON.

POCKET CUTLERY.

Champagne Knives. Chatelaine Knives. Cigar, Nail, Desk, and Erasing Knives. Hunting Knives. Instrument Knives—with few or many implements—in Ivory, Stag, or Tortoiseshell handles. Ladies' Knives. Pen Knives. Pocket, Pencil, Rule, Clasp, Sailors', Pen-machine, Pic-nic, and Masticating Knives.

SCISSORS OF ALL KINDS.

Button-hole, Cutting-out, Hair-cutting, Horse-trimming, Lamp, Paper, Kitchen, Whisker, and Surgical Scissors.

Ladies' Scissors. Lace, Work, Small Work, Embroidery, and Nail Scissors. Folding Scissors for the Pocket and Chatelaine. Cases of Ladies' Work Scissors, containing 2, 3, 4, or 6 pairs. Left-handed Scissors.

RAZORS AND TOILET CUTLERY.

Razors in Ivory, Tortoiseshell, or Black Handles. Guard Razors. Flush-backed Razors. Hollow-ground blade Razors. Army Razors. Cases of 2, 4, or 7 Razors. Roll cases of Razors and Toilet necessaries. Razor Hones. Razor Strops. Canton Strops. Boot Hooks. Button Hooks—solid or folding; Hunting ditto for Tops. Corn Files. Dressing-case Corkscrews. Tweezers. Dental Instruments. Nail Nippers. Improved "Perfect" ditto. Door Wedges. Dumb Bells. Steel Watch Guards. Dog Chains. Dog Collars. Swivels and Padlocks.

LOOKS ESPECIALLY DESIGNED FOR SECURING LEATHER STRAPS.

Key Rings of all kinds, plain or embossed, with name and address.

HUNTING KNIVES in Sheaths, plain or richly mounted. Skean Dhu Knives. Shikary Knives. Goorka Knives. Kookrie Knives. Boar and Bear Spears. Skinning Knives. Alpenstocks. Ice Axes. Climbing Irons. Riflemen's Knives. Fleams. Farriers' Knives. Cases of Farriers' Tools. Ditto for the Saddle. Horse-clipping Machines. Lancets. Veterinary Hammers and Hoof Picks.

SKATES of all patterns. Club Skates. Ladies' and Strapless Skates.

CORKSCREWS. Champagne Taps, Nippers, Hooks and Knives. Butlers' Cork screws. Telescope, Dressing-case, Pocket, and Lever Corkscrews. Ditto with Rack and Pinion, &c. Pocket Instrument Corkscrews, containing from 2 to 12 useful implements. Needles. Packing Needles. Strap Punches. Eyelet Punches, and Gentlemen's Housewives.

HOLTZAPFFEL & CO.'S PRACTICAL SETS OF PORTABLE TOOLS.

ARRANGED IN THE MOST COMPLETE FORM IN ROLL-UP POUCHES.

Selected for Carpentry, Canoeists, Engineers, Fishermen, Officers, Sportsmen, Travellers, Yachtsmen, and others.

The sets of Tools are of the Best Materials and Workmanship, the stems made all to fit into ONE HANDLE to economise space. They consist of Chisels, Gouges, Files, Hammers, Saws, Knives, Screwdrivers, Rasps, Rimers, Crow Irons, Gimlets, Bradawls, &c. In their more simple form, the Pouches contain sets of 12, 18, 24, 30, or 36 of the above named tools only.

In their more complete form the Roll Pouches contain sets as above, but with additional loops for a selection of tools which are independent of the handle, such as—

Callipers, Cold Chisels, Bolt-irons. Diestocks—cutting several sizes of screws; Drillstocks—carrying their bits in the handle; Jointed Drillbows of steel; Archimedean Drillstocks; Gages to measure to the 100th, or 1000th, of an inch; Gimlet Handles; Hand Vices; Oilstones in cases and oilstone slips; Oil Bottle with Drift; Planes of small sizes in gun metal; Cutting Pliers; Flat, Nipper, and Round Pliers; Cutting Compasses for Washers, &c. Punches of all kinds; Rules, Spirit Levels, Steel Screw Wrenches, Spokeshaves, Squares, Sliding Tong, Pin Vices. Table Vice, Watch Tools, &c., &c.

Many of the above tools especially constructed to combine strength and convenience with extreme portability.

HAMMER HATCHETS, combining Hammer, Hatchet, Crow Iron, Screwdriver, Fulcrum, Lever, and Wrench, forged in one solid piece.

GARDEN AND HORTICULTURAL CUTLERY.

Averuncators. Bill Hooks of all kinds. Budding Knives. Pruning Knives, straight and folding. Pruning Knives, with Saw. Pruning Saws. Grecian Pruning Saws. Flower Scissors. Scissors to cut and hold the flower. Grape Gatherers. Pruning Shears for the hand. Sliding Pruning Shears. Ladies' ditto. Large Pruning Shears in long handles. Sliding Pruning Shears in long handles. Hedge Shears. Grass Shears. Hatchets. Hammers. Hoes. Rakes. Trowels. Daisy Rakes. Daisy Grubs. Spuds. Syringes. Slashing Hooks, &c., &c.

SURGICAL KNIVES. Scalpels. Scissors. Forceps. Lancets. Needles, &c.

Pen Holder for enfeebled hand. Table Knife and Fork for ditto. Rheumatic Hammers.

Cases of Instruments for Botanists, Ornithologists, Taxidermists, &c., and for general purposes. Steelyards. Machines for making Quill Pens.

TABLE CUTLERY.

Bread Knives, in Ivory, Stag, or Wood, plain or carved Handles.

Table Knives and Dessert Knives, in plain Black Horn Handles, Bone Handles, Stag Horn Handles; in Stag Horn Handles with Silver Ferrules and Butts; in Ivory Handles; in Ivory balanced Handles; in Ivory balanced Handles with Silver Ferrules, &c., &c.

Carving Knives and Forks, and Poultry or Game Carvers, of all sizes, to match the above.

Trowel-shaped, or Round of Beef Carvers, in Stag or Ivory. Cooks' Knives. Steels. Knife Sharpeners, &c.

Table Knife and Fork combined, for use with one hand.

Complete sets of Table Cutlery, with or without cases.

Antlers, Tusks, Horns, Teeth, and other trophies mounted as any form of knife.

Knives engraved with crests, monograms, &c.

HOLTZAPFFEL & CO'S ENGINE-DIVIDED SCALES,

For Engineers, Architects, Draughtsmen, &c.

Every scale is ruled in the Dividing Engine, on a different slip of Specially-Prepared Cardboard, 18 inches long, the figures and inscription having been previously printed dry. By this arrangement the confusion of crowded scales is entirely avoided, and any of them may be applied directly to the drawing, or compared with one another, without the employment of the compasses; and as from their thinness they pass under the T square, no offsets are required. The material of the scales and of the drawing paper being IDENTICAL, both are equally affected by climate or temperature, and expand or contract equally together.

ORDINARY DRAWING SCALES.

A series of 24 scales, consisting of the usual reductions of the foot, viz., $\frac{1}{16}$, $\frac{1}{12}$, $\frac{1}{8}$, $\frac{3}{16}$, $\frac{1}{4}$, $\frac{5}{16}$, $\frac{3}{8}$, $\frac{1}{2}$, $\frac{5}{8}$, $\frac{3}{4}$, $\frac{7}{8}$, 1, $1\frac{1}{4}$, $1\frac{1}{2}$, 2, $2\frac{1}{2}$, 3, 4, 5, 6 inches to the foot, three lines of inches divided into eighths, tenths, and twelfths, and the English foot decimally divided.

The Set of 24 Scales in case, price £1 2s.

CHAIN SCALES.

A series of 24 scales, in Chains and Links, viz., 1, $1\frac{1}{2}$, 2, $2\frac{1}{2}$, 3, 4, 5, 6, 7, 8, 10, 12, 13.33, 15, 18, 20, 25, 30, 40, 50, 60, 70, 80, 100 chains to the inch.

The Set of 24 Scales in case, price £1 2s.

Single Scales of any of the above, and of many other varieties, kept in stock, price 1s. each.

Single Scales, graduated to order, in English or French measures, on separate slips of cardboard, 18 inches long, price 2s. each.

Single Scales of other measures, graduated to order, price 3s. each.

CIRCULAR CURVES,

For Railway Plans and analogous purposes, made as arcs of circles of any required radii between the two extremes of one inch and one mile.

Holtzapffel & Co. cut these curves in stout cardboard, made expressly for the purpose, as this material combines in the most suitable manner economy with convenience and permanence of form. The convex and concave edges of these curves are both made to the same radius, and they have received the approval, and permanent patronage, of the great majority of the Civil Engineers, Architects, and Surveyors of the United Kingdom.

The usual set consists of 60 curves, of radii increasing in due proportion from 1 to 120 inches. Those above 12 inches radius measure 3 inches in width and 18 inches in length.

The Set of 60 Curves in Plain Deal Case, price £2 10s.

Single Curves of any Radius kept in stock, price 1s. each.

Single Curves of any required Radius in English inches, feet, or chains. French metre, &c., cut to order, price 2s. each.

ENGINE-DIVIDED CIRCULAR CARD PROTRACTORS.

Every Protractor is ruled separately in the Dividing Engine, around either the outer or inner edge of a flat cardboard ring.

Holtzapffel & Co.'s Card Protractors being ruled and not printed, they possess the same accuracy as well as the other advantages of the Engine-divided Card Scales.

External Diameter—6 inch, 2s. 6d. ... 9 inch, 3s. 6d. ... 12 inch, 5s.

Internal ,, —6 ,, 3s. 0d. ... 9 ,, 4s. 6d. ... 12 ,, 6s.

THE ODONTAGRAPH,

Invented by Professor R. Willis, A.M., F.R.S., &c. This is an instrument of easy application, used for describing the teeth of wheels by circular arcs, so that any two wheels of a set may work truly together. The theoretical explanation of this system of setting out the teeth of wheels, which has been most extensively adopted by practical men, will be found in the Trans. Inst. Civil Engineers, vol. ii., and in Willis's Principles of Mechanism.

In Cardboard, with tables and instructions for use, varnished, price 5s.

In Brass, with tables and instructions for use, mounted, price £1 10s.

PLEASE DO NOT REMOVE
CARDS OR SLIPS FROM THIS POCKET

UNIVERSITY OF TORONTO LIBRARY

TT	Holtzapffel, John Jacob
H	Turning and mechanical
v.4	manipulation...
	v.4

